



**CERRAHİ SETLER
SURGICAL SETS**





BAHADIR Tibbi Aletler 1983 yılında Samsun'da kurulmuştur. Üretim kalitesinin yüksekliği, satış ve servis organizasyonu ile bu alanda lider olarak tanınmaktadır.

Kataloğumuzda yer alan ürünlerimiz, ham malzemeden son ürün haline gelinceye kadar bilgi, beceri, deneyimlerimiz ve yüksek teknolojiyle desteklenerek titiz bir kalite denetim sistemi içerisinde üretilmiştir. Aksi belirtilmedikçe kataloğumuzda yer alan ürünlerimiz, uygun spesifikteki paslanmaz çelikten üretilmiş, çizimler ve resimler gerçek boyutlarında verilmiştir.

Gectiğimiz yıllar boyunca tıp camiasından gördüğümüz yakın ilgi, güven ve destek sayesinde bugün cerrahi branşların hemen hepsi için alet üretiyoruz. Ürünlerimiz uluslararası pazarlarda haklı bir üne kavuşmuştur.

Göz Cerrahi üretim programımızı içeren bu kataloğumuz ile birlikte K.B.B ve Plastik Cerrahi, Endoskopi, Steril Konteyner Sistemleri kataloglarımız ve cerrahi branşlara göre hazırlanmış kataloglarımız mevcuttur. Kataloglarımız gelişen tıbbi teknikler ve yaklaşımlar ile ortaya çıkan yeni dizayn alet ve setleri de kapsayacak şekilde titiz bir çalışma ile hazırlanmıştır.

Sizlere sunacaklarımız bu kataloglarla sınırlı değildir. Alet ve setlerinizin bakım ve onarımı, mevcut dizaynlar üzerinde değişiklik istekleriniz, yeni cerrahi teknikler için geliştireceğiniz aletlerin üretimi ve bu katalogta yer almayan diğer ürünler için teknik olanaklarımız, bilgi ve deneyimlerimiz daima emrinizde olacaktır.

Tıp camiasına ve bu katalogun hazırlanmasında emeği geçenlere öneri ve eleştirileri ile bizleri yönlendirenlere teşekkür ederiz.



Being established in 1983 in Samsun / Turkey, BAHADIR Medical Equipment has been recognized as a leader in the production of Surgical Instruments for its exceptional quality products, sales and wide range of service organization.

All instruments pictured in this catalog are the products of consistent craftsmanship combined with advanced production techniques and traditional skills acquired over the years. Forging to crafting-utmost care has been taken to ensure accuracy in every stage of production and our strive continues to achieve highest standards and top quality products. Instruments displayed here are stainless steel and they are shown in full scale unless otherwise indicated.

BAHADIR enjoys a significant reputation of manufacturing instruments for all surgical branches, thanks to close cooperation and support from our medical society which made them competitive international markets.

In addition to this catalog, we also have supplemental catalogues for ENT, Endoscopy and Steril Container System available on request. We are, however, conscious of the fact that this catalog remains insufficient to cover all the facilities and novelties we can offer. It is our endeavor to develop new products as new technology and demands for new procedures become known.

We will always be at your disposal with our technical facilities knowledge and vast experience for your specific needs including refurbishment of your instruments and sets, modification of present patterns, custom-made production on entirely new designs developed to your surgical techniques as well as any other product which is not displayed here.

BAHADIR would like to thank all those who have co-operated in the compilation of this catalog.





GARANTİ / GUARANTEE

BAHADIR tescilli markasını ve logosunu taşıyan ürünler malzeme ve işçilik açısından beş yıl garantilidir. Bu süre içinde normal kullanım koşullarında arızalanan aletler ücretsiz olarak onarılacak yada yenisi ile değiştirilecektir.

All products carrying the registered trademark and logo of BAHADIR are guaranteed for five years in respect of material and workmanship in normal use. We will replace or repair any damaged instrument free of charge during this period.

Her hakkı saklıdır.

Bu kataloğun hiçbir bölümü BAHADIR'ın yazılı izni olmadan kopya edilemez, yayınlanamaz.

All rights reserved.

No part of this catalog may be reproduced in any form without written permission from BAHADIR.

Grafik / Graphic : BAHADIR

Baskı/Print : GÜVEN OFSET - SAMSUN



CERRAHİ SETLER SURGICAL SETS

BAHADIR TIBBİ ALETLER SANAYİ VE TİCARET A.Ş.
BAHADIR MEDICAL EQUIPMENT INDUSTRY AND TRADE CO.
Organize Sanayi 55 300 / KUTLUKENT / SAMSUN / TURKEY
Tel : 90 (362) 266 70 01 (Pbx) Fax : 90 (362) 266 70 05
www.bahadir.com.tr E-mail : info@bahadir.com.tr

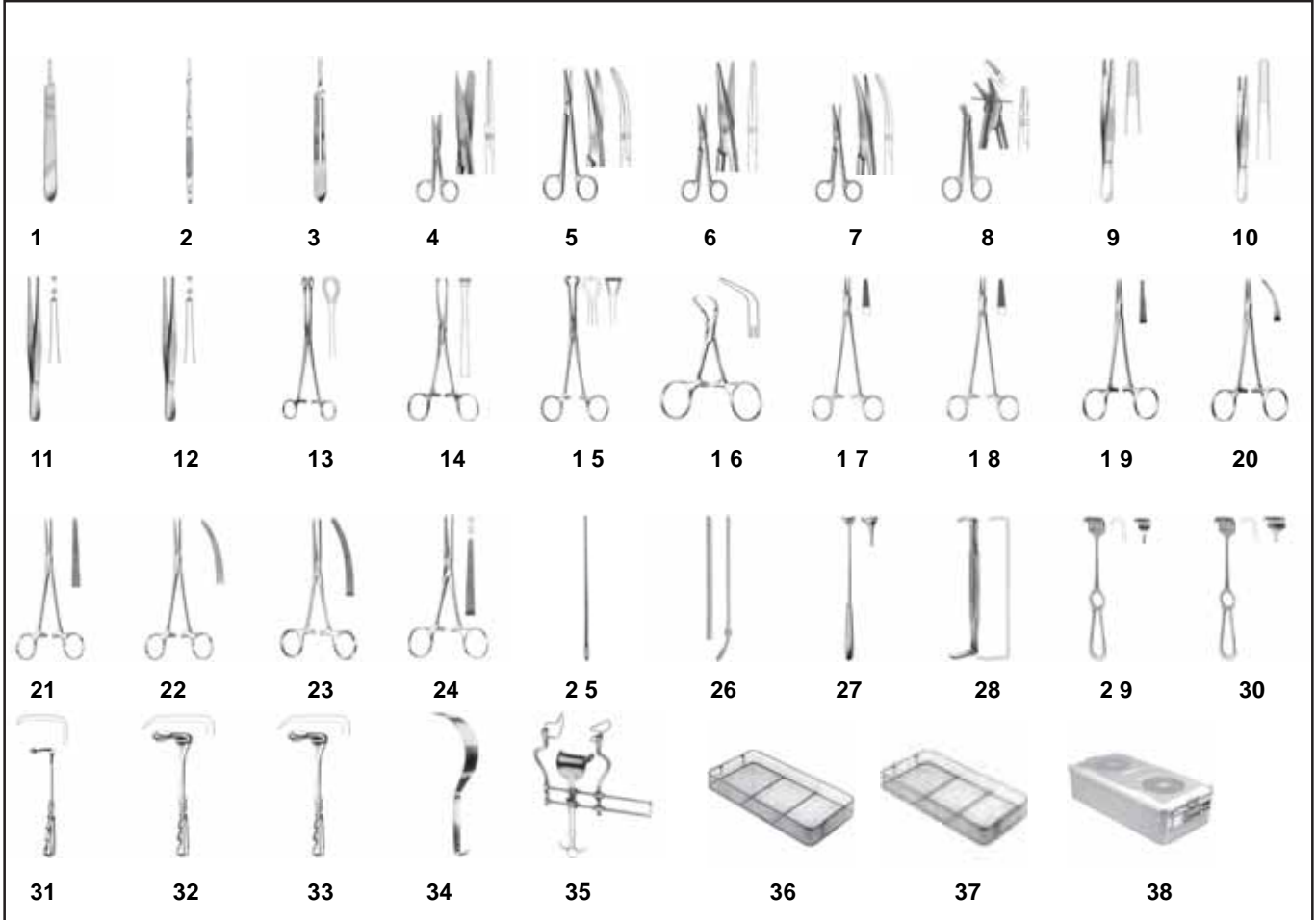

No	Quantity	Code	Description
1	1	B 030.01	Scalpel Handle 3 no, 13.5 cm
2	1	B 032.00	Scalpel Handle 3 no, 16.5 cm
3	1	B 040.01	Scalpel Handle 4 no, 13.5 cm
4	1	C 310.03	Surgical Scissors, Straight, 14.5 cm
5	1	C 421.01	Metzenbaum Dissecting Scissors, Curved, 18 cm
6	1	C 442.01	Mayo Stille Surgical Scissors, Straight, 17 cm
7	1	C 443.01	Mayo Stille Surgical Scissors, Curved, 17 cm
8	1	C 668.00	Wire and Plate Scissors, One jaw serrated, 12 cm
9	2	D 240.02	Standart Dissecting Forcep, 14.5 cm
10	1	D 240.05	Standart Dissecting Forcep, 20 cm
11	2	D 360.03	Standart Tissue Forcep, 14.5 cm
12	1	D 360.06	Standart Tissue Forcep, 20 cm
13	6	E 086.00	Foerster-Ballenger Organ and Tissue Forcep, Straight, 24 cm
14	6	E 144.00	Allis Tissue Grasping Forcep, 5x6 teeth, 15.5 cm
15	2	E 174.00	Babcook Organ and Tissue Grasping Forcep, 16 cm
16	12	E 430.02	Backhaus Towel Clamp, 13.5 cm
17	2	F 355.00	Hegar-Mayo Needle Holder, 15 cm
18	2	F 355.01	Hegar-Mayo Needle Holder, 18 cm
19	12	G 206.00	Micro-Halsted Delicate Haemostatic Forcep, Straight, 12.5 cm
20	12	G 207.00	Micro-Halsted Delicate Haemostatic Forcep, Curved, 12.5 cm
21	6	G 264.00	Crile Delicate Haemostatic Forcep, Straight, 16 cm
22	6	G 265.00	Crile Delicate Haemostatic Forcep, Curved, 16 cm
23	12	G 431.00	Rochester-Pean Haemostatic Forcep, Curved, 16 cm
24	6	G 438.00	Rochester—Ochsner Haemostatic Forcep, Straight, 14 cm
25	1	J 035.00	Probe, Ø 2.5 mm 14.5 cm
26	1	J 437.00	Pool Suction Tube, Olive Ø 6.5-9.5 mm, Ø 7 mm, 22.5 cm
27	2	K 274.00	Cushing Retractor, 11x14 mm, 25 cm
28	1	K 342.00	Us.Army Retractor, 22 cm
29	2	K 433.02	Vollkman Retractor, Blunt, 8x19 mm. 22 cm
30	2	K 433.03	Vollkman Retractor, Blunt, 8x29 mm. 22 cm
31	2	K 491.00	Richardson Retractor, 47x21 24 cm
32	2	K 492.00	Kelly Retractor, 64x54 mm, 26 cm
33	2	K 492.01	Kelly Retractor, 70x65 mm, 26 cm
34	2	K 660.07	Deaver Retractor, 50 mm, 31 cm
35	1	L 534.00	Balfour Abdominal Retractor Set
36	1	Y 190.05	Wire Basket, 485x255x50 mm
37	1	Y 190.07	Wire Basket, 485x255x70 mm
38	1	Y 110.15	1/1 Size Container , Basic model, 580x280x150 mm

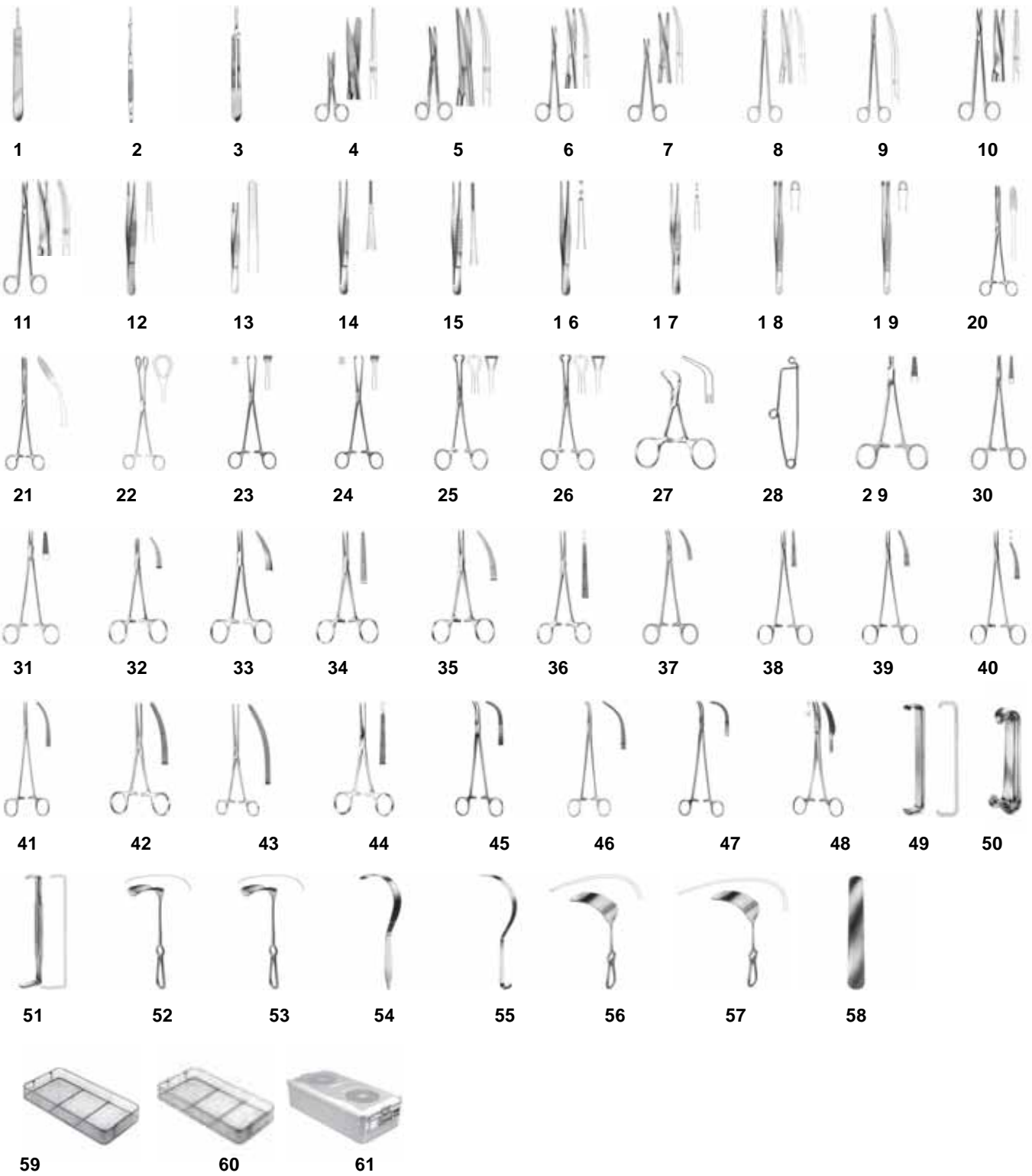

No	Quantity	Code	Description
1	1	B 030.01	Scalpel Handle 3 no, 13.5 cm
2	1	B 030.02	Scalpel Handle 3 no, 21.5 cm
3	2	B 040.01	Scalpel Handle 4 no, 13.5 cm
4	2	C 310.03	Surgical Scissors, Straight, 14.5 cm
5	2	C 731.00	Mayo-Lexer Dissecting Scissors, Curved, 16.5 cm
6	1	C 753.00	Baby-Metzenbaum Dissecting Scissors, Curved, 14.5 cm
7	1	C 756.02	Metzenbaum Dissecting Scissors, Curved, 20 cm
8	1	C 761.00	Nelson-Metzenbaum(Mc Indore) Scissors, Curved, 23 cm
9	1	C 761.01	Nelson-Metzenbaum(Mc Indore) Scissors, Curved, 30 cm
10	1	C 763.00	Metzenbaum Dissecting Scissors, Straight, 18 cm
11	2	C 764.00	Metzenbaum Dissecting Scissors, Curved, 18 cm
12	2	D 225.02	Dissecting Forcep, Straight, 14.5 cm
13	1	D 240.07	Standart Dissecting Forcep, 30 cm
14	1	D 262.00	De Bakey Atraumatic Forcep, 2 mm, 15 cm
15	1	D 262.01	De Bakey Atraumatic Forcep, 2 mm, 20 cm
16	1	D 360.06	Standart Tissue Forcep, 20 cm
17	2	D 361.02	Tissue Forcep, Straight, 14.5 cm
18	1	D 390.00	Russ.Modell Dissecting Forcep, 15 cm
19	1	D 390.01	Russ.Modell Dissecting Forcep, 20 cm
20	1	E 054.00	Maier Sponge and Dressing Forcep, Straight, 26.5 cm
21	1	E 055.00	Maier Sponge and Dressing Forcep, Curved, 26.5 cm
22	2	E 130.00	Tissue Grasping Forcep, 25 cm
23	2	E 150.00	Allis Tissue Grasping Forcep, 15.5 cm
24	1	E 150.06	Allis Tissue Grasping Forcep, 25.5 cm
25	1	E 174.00	Babcook Organ and Tissue Grasping Forcep, 16 cm
26	1	E 174.01	Babcook Organ and Tissue Grasping Forcep, 21.5 cm
27	10	E 430.01	Backhaus Towel Clamp, 11 cm
28	2	E 481.00	Mayo Safety Pin, 14 cm
29	2	F 333.00	Crile-Wood Needle Holder, HM, 14.5 cm
30	2	F 346.00	De Bakey Needle Holder, 18 cm
31	2	F 355.02	Hegar-Mayo Needle Holder, 20.5 cm
32	13	G 215.00	Halsted-Mosquito Delicate Haemostatic Forcep, Curved, 12.5 cm
33	2	G 231.00	Providence-Hospital Delicate Haemostatic Forcep, Curved 14 cm
34	10	G 240.00	Crile Delicate Haemostatic Forcep, Straight 14 cm
35	5	G 241.00	Crile Delicate Haemostatic Forcep, Curved 14 cm
36	6	G 268.00	Crile Delicate Haemostatic Forcep, Straight, 1x2 teeth 16 cm
37	1	G 275.00	Nissen Delicate Haemostatic Forcep, Curved, 16 cm
38	2	G 280.00	Halsted Delicate Haemostatic Forcep, Straight, 18.5 cm
39	1	G 281.00	Halsted Delicate Haemostatic Forcep, Curved, 18.5 cm
40	1	G 285.00	Halsted Delicate Haemostatic Forcep, Curved, 1x2 teeth 18.5 cm
41	4	G 291.00	Halsted-Mosquito Delicate Haemostatic Forcep, Curved, 20 cm
42	2	G 431.01	Rochester-Pean Haemostatic Forcep, Curved, 18.5 cm
43	1	G 435.02	Pean Haemostatic Forcep, 28 cm
44	4	G 448.02	Kocher-Ochsner Haemostatic Forcep, Straight, 1x2 teeth 20 cm
45	2	G 620.00	Overholt-Geissendoerfer Dissecting Forcep, 19.5 cm
46	2	G 640.02	Overholt Dissecting Forcep, 22 cm
47	2	G 654.00	Mixter Ligature Forcep, Curved, 23 cm
48	8	G 695.00	Mikulicz Peritoneum Forcep, 20 cm
49	2	K 311.00	Farabeuf Retractor, 15 cm
50	1	K 325.00	Roux Retractor, Complete, 16.5 cm
51	2	K 342.00	Us.Army Retractor, 22 cm
52	1	K 605.04	Kocher Retractor, 80x42 mm, 25 cm
53	1	K 605.06	Kocher Retractor, 80x60 mm, 25 cm
54	1	K 660.02	Deaver Retractor, 22 mm, 21.5 cm
55	1	K 660.04	Deaver Retractor, 75 mm, 30 cm
56	1	K 700.02	Mikulicz Retractor, 121x50 mm, 25 cm
57	1	K 700.03	Mikulicz Retractor, 147x50 mm, 25 cm
58	1	K 760.00	Haberer Spatula, Malleable, 40x50 mm, 30.5 cm
59	1	Y 190.05	Wire Basket, 485x255x50 mm
60	1	Y 190.07	Wire Basket, 485x255x70 mm
61	1	Y 110.15	1/1 Size Container , Basic model, 580x280x150 mm

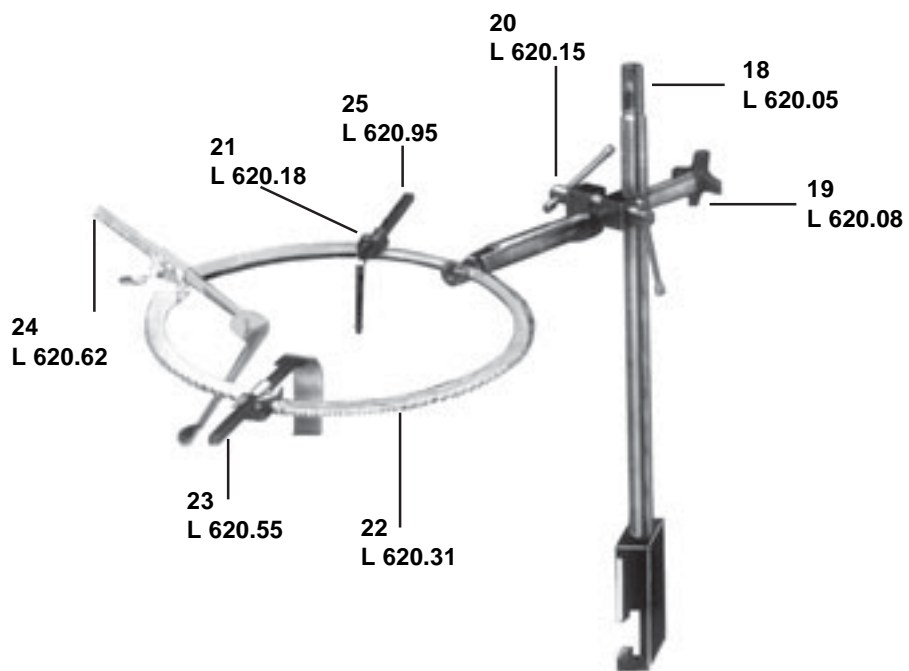
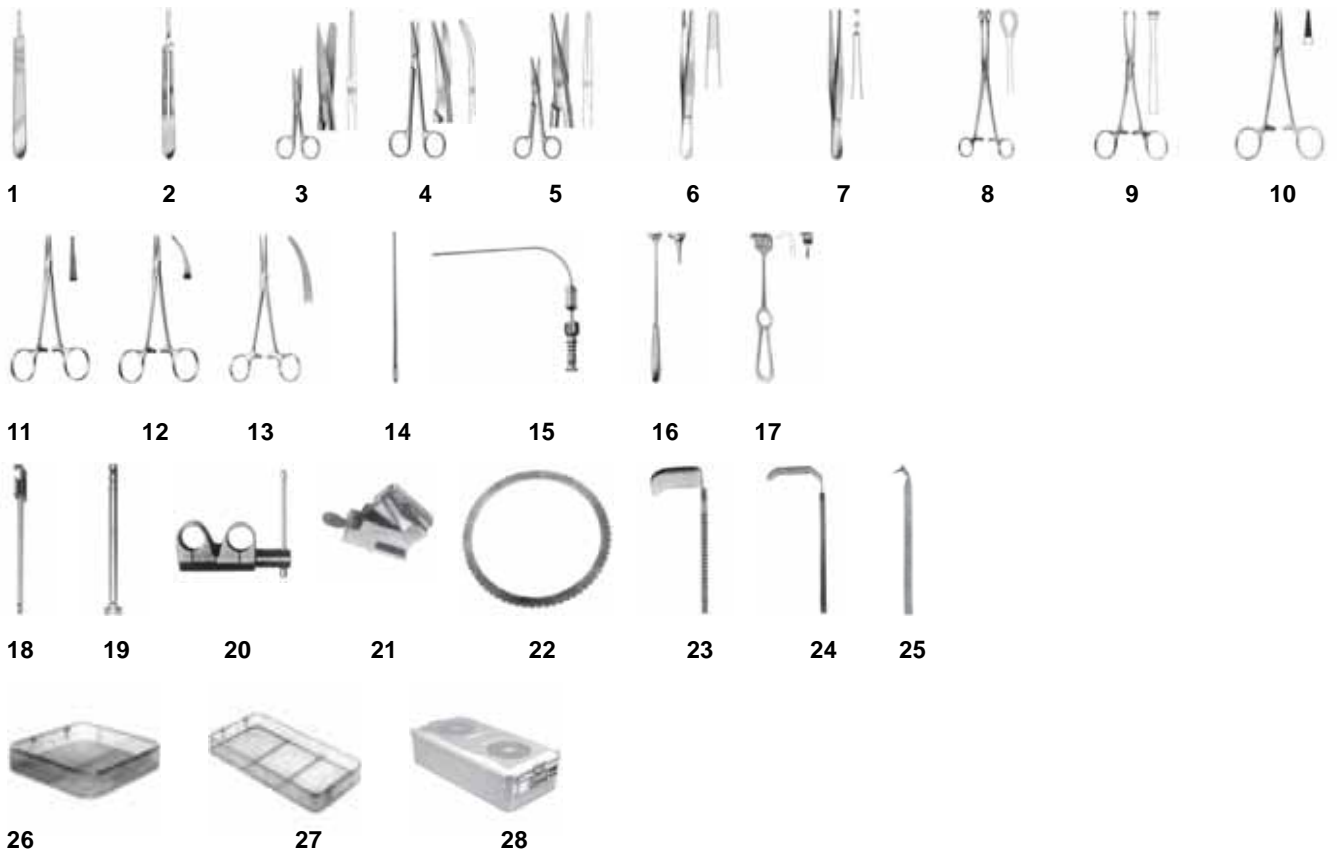

Bookwalter Small Incision Kit

No	Quantity	Code	Description
1	2	B 030.01	Scalpel Handle 3 no, 13.5 cm
2	2	B 040.01	Scalpel Handle 4 no, 13.5 cm
3	2	C 310.03	Surgical Scissors, Straight, 14.5 cm
4	2	C 421.01	Metzenbaum Dissecting Scissors, Curved, 18 cm
5	2	C 442.01	Mayo Stille Surgical Scissors, Straight, 17 cm
6	2	D 240.02	Standart Dissecting Forcep, 14.5 cm
7	2	D 360.03	Standart Tissue Forcep, 14.5 cm
8	2	E 086.00	Foerster-Ballenger Organ and Tissue Forcep, Straight, 24 cm
9	2	E 144.00	Allis Tissue Grasping Forcep, 5x6 teeth, 15.5 cm
10	2	F 328.00	Baby-Crile-wood Needle Holder, HM, 15 cm
11	4	G 206.00	Micro-Halsted Delicate Haemostatic Forcep, Straight, 12.5 cm
12	4	G 207.00	Micro-Halsted Delicate Haemostatic Forcep, Curved, 12.5 cm
13	4	G 265.00	Crile Delicate Haemostatic Forcep, Curved, 16 cm
14	1	J 035.00	Probe, Ø 2.5 mm 14.5 cm
15	1	J 217.01	Frazier Suction Tube, Ø 3 mm, 19 cm
16	2	K 274.00	Cushing Retractor, 11x14 mm, 25 cm
17	2	K 433.01	Vollkman Retractor, Blunt, 8x13 mm. 22 cm

Bookwalter Small Incision Kit

18	1	L 620.05	Bookwalter Table Post, 2.5 mm, 43 cm
19	1	L 620.08	Bookwalter -Kelly Retractor, 36.5 cm
20	1	L 620.15	Bookwalter Post Coupling
21	3	L 620.18	Bookwalter Tilt Ratchet Mechanisms
22	1	L 620.31	Bookwalter Abdominal Retractor, Ø215 mm
23	1	L 620.55	Bookwalter-Kelly Abdominal Retractor, 51x64 mm
24	1	L 620.62	Bookwalter-Kelly Abdominal Retractor, 25x75 mm
25	1	L 620.95	Bookwalter-Gelpi Abdominal Retractor, 51 mm
26	1	Y 390.05	Wire Basket, 255x245x50 mm
27	1	Y 191.07	Wire Basket, 540x255x70 mm
28	1	Y 110.15	1/1 Size Container, Basic Model, 580x280x150 mm

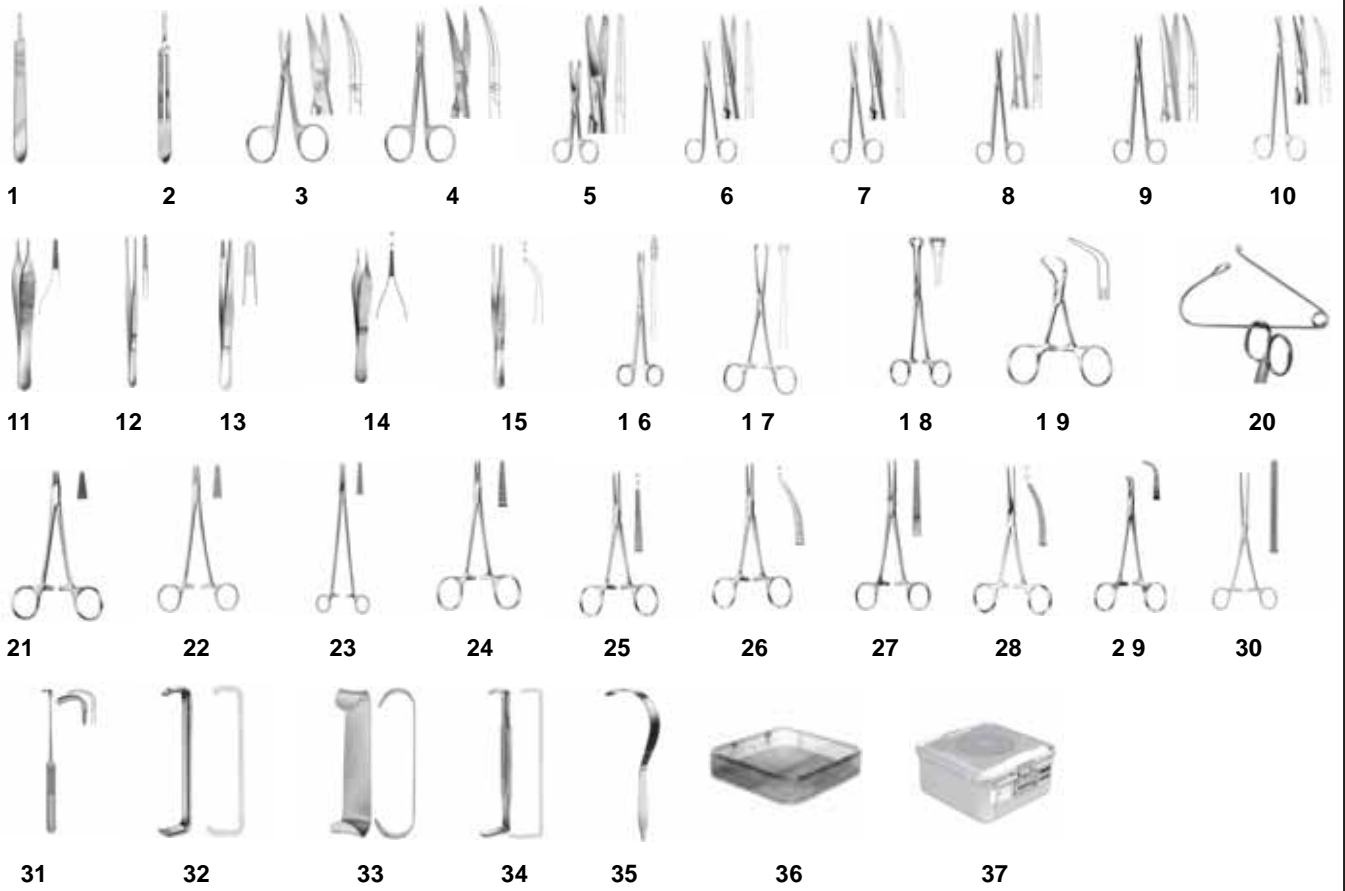

No	Quantity	Code	Description
1	1	B 030.01	Scalpel Handle 3 no, 13.5 cm
2	1	B 040.01	Scalpel Handle 4 no, 13.5 cm
3	1	C 222.01	Delicate Scissors, Curved, 9.5 cm
4	1	C 223.01	Delicate Scissors, Curved 10.5 cm
5	1	C 312.02	Surgical Scissors, Straight, 13 cm
6	1	C 412.00	Baby-Metzenbaum Dissecting Scissors, Straight, 14.5 cm
7	1	C 413.00	Baby-Metzenbaum Dissecting Scissors, Curved, 14.5 cm
8	1	C 414.00	Metzenbaum Dissecting Scissors, Straight, 16 cm
9	1	C 414.05	Metzenbaum Dissecting Scissors, Curved, 16 cm
10	1	C 416.00	Toennis-Adson Dissecting Scissors, Curved, 17.5 cm
11	1	D 205.00	Adson Delicate Dissecting Forcep, 12 cm
12	1	D 219.00	Dissecting Forcep, Straight, 15.5 cm
13	1	D 240.01	Standart Dissecting Forcep, 135 cm
14	1	D 324.00	Adson Delicate Tissue Forcep, 12 cm
15	1	D 362.00	Tissue Forcep, 14.5 cm
16	1	E 014.00	Gross Dressing Forcep, Straight, 18 cm
17	2	E 143.00	Boys-Allis Tissue Grasping Forcep, 5x6 teeth, 15.5 cm
18	2	E 170.00	Babcock Tissue Forcep, 15.5 cm
19	5	E 430.00	Backhaus Towel Clamp, 9 cm
20	1	E 480.00	Bunt Safety Pin, 10.5 cm
21	1	F 210.00	Baumgartner Needle Holder, 14.5 cm
22	1	F 223.01	Mayo-Hegar Needle Holder, 14.5 cm
23	1	F 238.00	Wangensteen Needle Holder, 27.5 cm
24	4	G 214.00	Halsted-Mosquito Delicate Haemostatic Forcep, Straight, 14 cm
25	2	G 244.00	Crile Delicate Haemostatic Forcep, Straight, 1x2 teeth, 14 cm
26	1	G 245.00	Crile Delicate Haemostatic Forcep, Curved, 1x2 teeth, 14 cm
27	4	G 260.00	Rankin Delicate Haemostatic Forcep, Straight, 16 cm
28	2	G 449.02	Kocher-Ochsner Haemostatic Forcep, 1x2 teeth, 20 cm
29	1	G 617.01	Baby-Adson Dissecting Forcep, 18 cm
30	2	H 357.01	Hartmann Intestinal Clamp, Elastic, Straight, 20 cm
31	1	K 205.00	Strandell-Stille Retractor, Blunt, 15x6 mm, 18 cm
32	2	K 310.00	Farabeuf Retractor, 12.5 cm
33	2	K 323.00	Kilner Retractor, 15 cm
34	2	K 342.00	Us.Army Retractor, 22 cm
35	2	K 660.02	Deaver Retractor, 22 mm, 21.5 cm
36	1	Y 390.07	Wire Basket, 255x245x70 mm
37	1	Y 310.15	1/2 Size Container, Basic Model, 285x280x150 mm

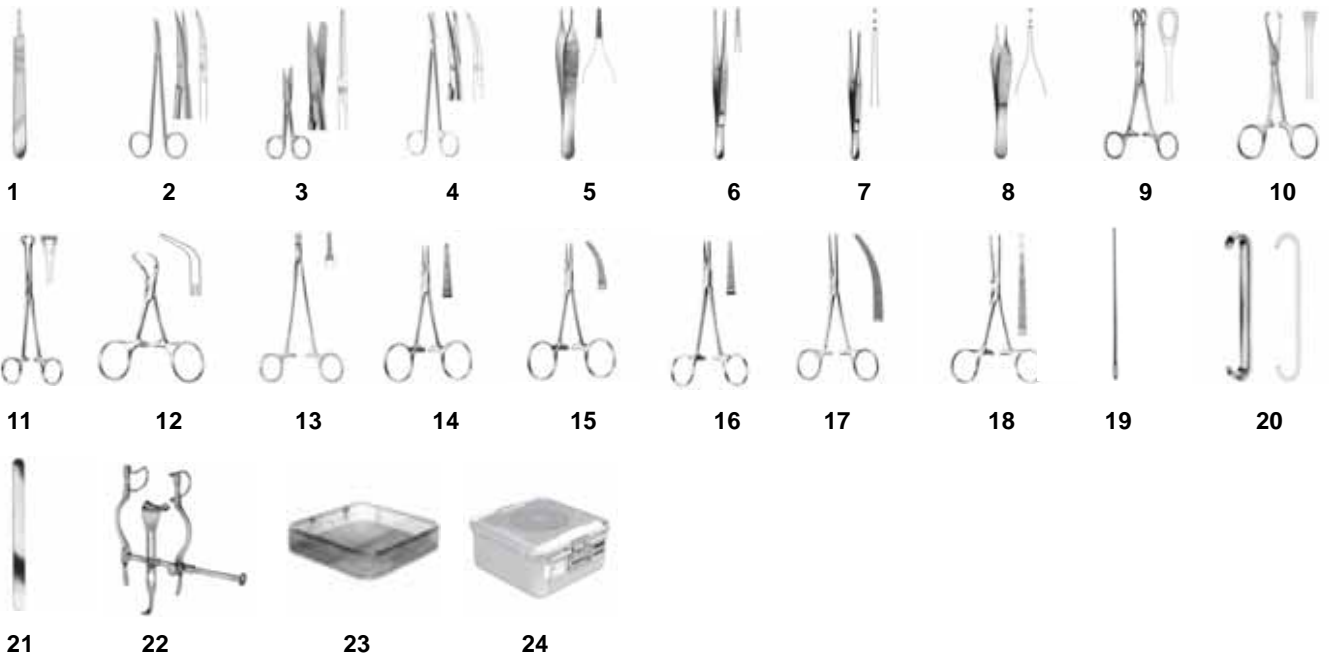

No	Quantity	Code	Description
1	2	B 030.01	Scalpel Handle 3 no, 13.5 cm
2	1	C 258.00	Delicate Scissors Curved, 15 cm
3	1	C 310.00	Surgical Scissors, Straight, 10.5 cm
4	1	C 416.00	Toennis-Adson Dissecting Scissors, Curved, 17.5 cm
5	1	D 205.00	Micro Adson Delicate Dissecting Forcep, 12 cm
6	1	D 218.00	Semken Dissecting Forcep, 12.5 cm
7	1	D 309.00	Semken Delicate Tissue Forcep, 12.5 cm
8	1	D 323.00	Adson Delicate Tissue Forcep, 12 cm
9	3	E 082.00	Foerster-Ballenger Organ and Tissue Forcep, Straight 18 cm
10	4	E 141.00	Tuffier Tissue Grasping Forcep, 5x6 teeth, 12.5 cm
11	4	E 170.00	Babcock Tissue Forcep, 15.5 cm
12	6	E 430.00	Backhaus Towel Clamp, 9 cm
13	2	F 381.01	Ryder Needle Holder, 13.5 cm
14	6	G 200.00	Baby-Mosquito Delicate Haemostatic Forcep, Straight, 10 cm
15	6	G 201.00	Baby-Mosquito Delicate Haemostatic Forcep, Curved, 10 cm
16	6	G 220.00	Baby-Crile Delicate Haemostatic Forcep, Straight, 14 cm
17	6	G 421.01	Pean Haemostatic Forcep, Curved, 14 cm
18	3	G 440.01	Kocher Haemostatic Forcep, Straight, 13 cm
19	1	J 035.00	Probe, Ø 2.5 mm 14.5 cm
20	1	K 314.00	Parker Retractor, 13.5 cm
21	1	K 752.00	Spatula Malleable, 200x12 mm
22	1	L 524.00	Balfour-Baby Abdominal Retractor, 9x11.5x12.5 cm Bleyd 27 mm
23	1	Y 390.07	Wire Basket, 255x245x70 mm
24	1	Y 310.13	1/2 Size Container, 285x280x135 mm

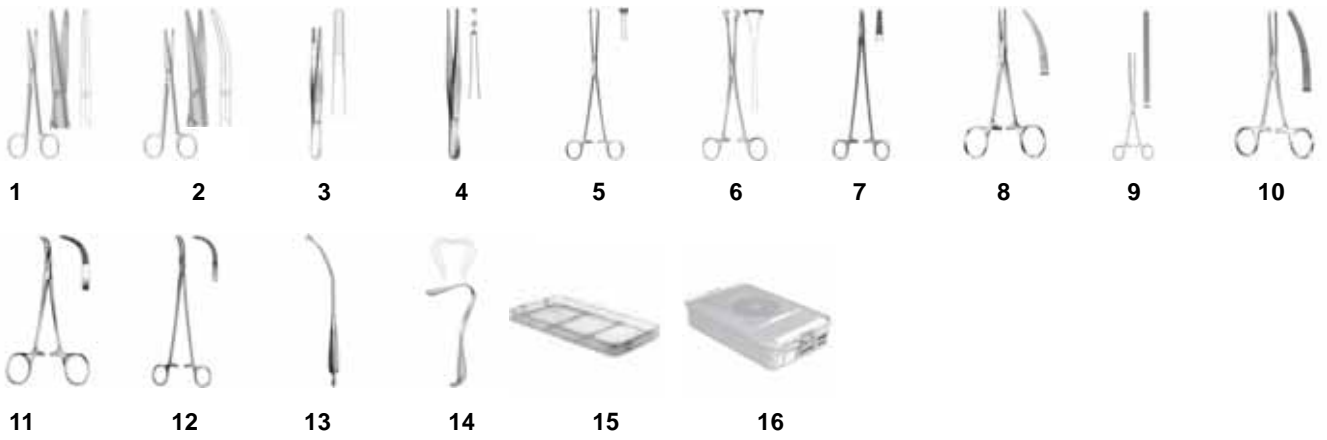

No	Quantity	Code	Description
1	1	C 458.01	Mayo Surgical Scissors, Straight, 20 cm
2	1	C 459.01	Mayo Surgical Scissors, Curved, 20 cm
3	2	D 240.05	Standart Dissecting Forcep, 20 cm
4	2	D 360.06	Standart Tissue Forcep, 20 cm
5	6	E 147.01	Allis Tissue Grasping Forcep, 5x6 teeth, 19 cm
6	3	E 171.02	Babcock Tissue Grasping Forcep, 22 cm
7	1	F 357.01	Hegar Needle Holder, HM, 24.5 cm
8	18	G 241.00	Crile Delicate Haemostatic Forcep, Curved, 14 cm
9	4	G 368.02	Doyen Intestinal Clamp, Elastic, Straight, 23.5 cm
10	6	G 431.02	Rochester-Pean Haemostatic Forcep, Curved, 20 cm
11	6	G 616.01	Baby-Mixer Ligature Forcep, Curved, 18 cm
12	3	G 654.00	Mixer Ligature Forcep, Curved, 23 cm
13	1	J 301.00	Yankauer Suction Tube, Ø 2 mm 28.5 cm
14	2	K 620.01	Harrington Retractor, Flexible, 123x64 mm, 29.5 cm
15	1	Y 290.07	Wire Basket, 405x255x70 mm
16	1	Y 210.10	3/4 Size Container, Basic Model, 465x280x100 mm

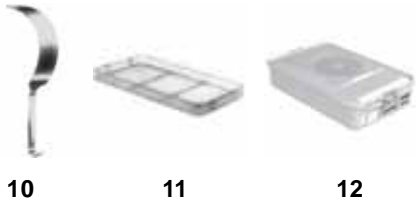
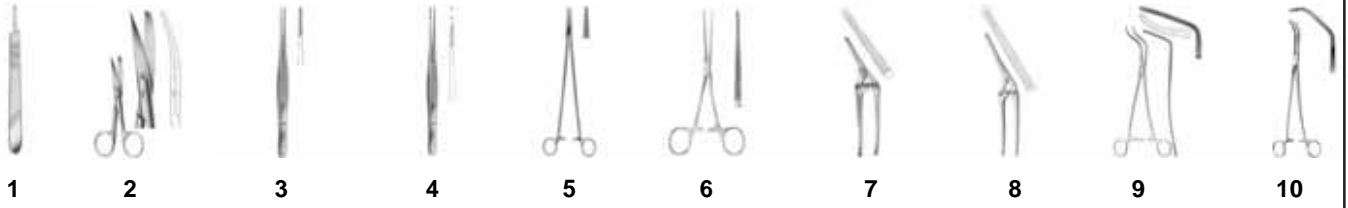

No	Quantity	Code	Description
1	1	B 030.01	Scalpel Handle, 3 no 13.5 cm
2	1	D 220.01	Cushing Dissecting Forcep, Straight, 20 cm
3	1	D 382.01	Waugh Tissue Forcep, Straight, 20 cm
4	1	F 238.00	Wangensteen Needle Holder, 27.5 cm
5	2	G 330.00	Allen Intestinal Clamp, Straight, 15.5 cm
6	1	G 580.02	Payr Intestinal Clamp, 68 mm, 20 cm
7	1	G 580.04	Payr Intestinal Clamp, 68 mm, 20 cm
8	2	H 577.00	De Bakey Vascular Clamp, Ø 70 26.5 cm
9	2	H 661.02	Satinsky Vascular Clamp, 26.5 cm
10	2	K 660.08	Deaver Retractor, 75 mm, 32 cm
11	1	Y 290.07	Wire Basket, 405x255x70 mm
12	1	Y 210.10	3/4 Size Container, Basic Model, 465x280x100 mm

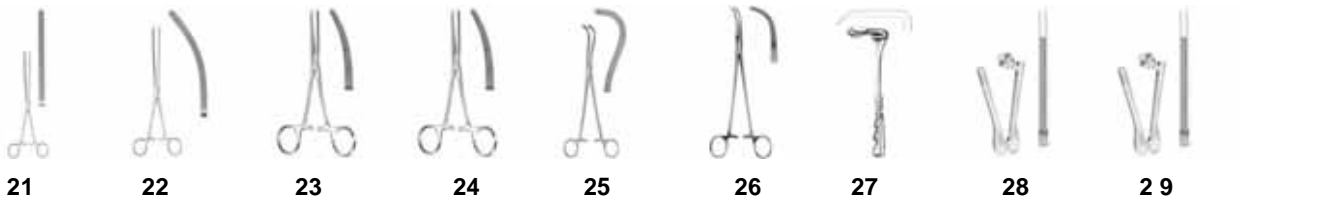
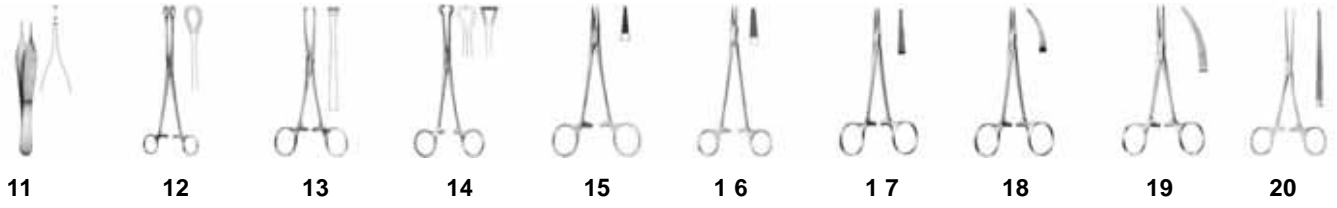
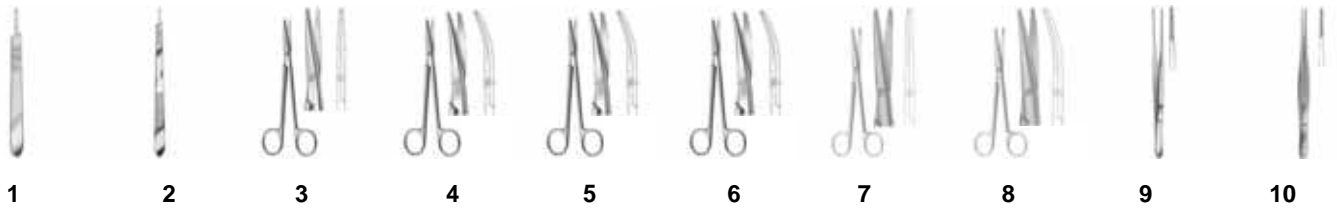

No	Quantity	Code	Description
1	1	B 030.01	Scalpel Handle 3 no, 13.5 cm
2	1	B 030.02	Scalpel Handle 3 no, 21.5 cm
3	1	C 420.00	Metzenbaum Dissecting Scissors, Straight, 14.5 cm
4	1	C 421.00	Metzenbaum Dissecting Scissors, Curved, 14.5 cm
5	1	C 421.01	Metzenbaum Dissecting Scissors, Curved, 18 cm
6	1	C 421.02	Metzenbaum Dissecting Scissors, Curved, 20 cm
7	1	C 458.01	Mayo Surgical Scissors, Straight, 20 cm
8	1	C 459.01	Mayo Surgical Scissors, Curved, 20 cm
9	2	D 219.00	Dissecting Forcep, Straight, 15.5 cm
10	2	D 220.01	Cushing Dissecting Forcep, Straight, 20 cm
11	2	D 323.00	Adson Delicate Tissue Forcep, 12 cm
12	2	E 086.00	Foerster-Ballenger Organ and Tissue Forcep, Straight, 24 cm
13	6	E 144.00	Allis Tissue Grasping Forcep, 5x6 teeth, 15.5 cm
14	2	E 174.00	Babcock Organ and Tissue Grasping Forcep, 16 cm
15	2	F 328.00	Baby-Crile-wood Needle Holder, HM, 15 cm
16	2	F 355.01	Hegar-Mayo Needle Holder, 18 cm
17	24	G 206.00	Micro-Halsted Delicate Haemostatic Forcep, Straight, 12.5 cm
18	12	G 207.00	Micro-Halsted Delicate Haemostatic Forcep, Curved, 12.5 cm
19	12	G 241.00	Crile Delicate Haemostatic Forcep, Curved, 14 cm
20	4	G 330.00	Allen Intestinal Clamp, Straight, 15.5 cm
21	2	G 368.02	Doyen Intestinal Clamp, Elastic, Straight, 23.5 cm
22	2	G 369.02	Doyen Intestinal Clamp, Elastic, Curved, 23.5 cm
23	12	G 431.00	Rochester-Pean Haemostatic Forcep, Curved, 16 cm
24	4	G 431.02	Rochester-Pean Haemostatic Forcep, Curved, 20 cm
25	1	G 468.00	Guyon Kidney Clamp, 23.5 cm
26	2	G 672.00	Lahey Dissecting Forcep, 19 cm
27	2	K 492.01	Kelly Retractor, 70x65 mm, 26 cm
28	1	G 586.00	Kenastmosis Clamp 7 cm
29	1	G 586.01	Kersting Anostomosis Clamp 8.5 cm
30	1	Y 290.07	Wire Basket, 405x255x70 mm
31	1	Y 210.13	3/4 Size Container, Basic Model, 465x280x135 mm



1



2



3



4



5



6



7



8



9



Appendectomy Set

No	Quantity	Code	Description
1	1	B 030.01	Scalpel Handle 3 no, 13.5 cm
2	1	B 040.01	Scalpel Handle 4 no, 13.5 cm
3	1	C 311.03	Surgical Scissors, Curved, 14.5 cm
4	1	C 360.00	Graefe Dissecting Scissors, 40°, 10 cm
5	1	D 240.02	Dissecting Forcep, 14.5 cm
6	1	F 230.01	Mayo-Hegar Needle Holder, 18 cm
7	1	G 220.00	Baby-Crile Delicate Haemostatic Forcep, Straight, 14 cm
8	1	G 221.00	Baby-Crile Delicate Haemostatic Forcep, Curved, 14 cm
9	2	K 491.00	Richardson Retractor, 47x21 24 cm



1



2



3



4



5



6



7



8



9

No	Quantity	Code	Description
1	1	B 030.02	Scalpel Handle 3 no, 21.5 cm
2	1	C 423.02	Nelson-Metzenbaum Dissecting Scissors 28 cm
3	2	D 240.07	Dissecting Forcep, Straight, 30 cm
4	2	G 459.00	Pean Kidney Clamp, 19.5 cm
5	2	G 672.00	Lahey Dissecting Forcep, 19 cm
6	2	K 107.01	Adson Nerve Hook, Blunt, Ø 9 mm, 20 cm
7	2	K 490.02	Richardson Retractor, 37x37 mm 24 cm
8	1	Y 390.05	Wire Basket, 255x245x70 mm
9	1	Y 310.10	1/2 Size Container, 285x280x100 mm



1



2



3



4



5



6



7



8



9



10



11



12



13



14



15

No	Quantity	Code	Description
1	1	B 030.01	Scalpel Handle, 3 No, 13.5 cm
2	1	C 459.01	Mayo Surgical Scissors, Curved, 20 cm
3	1	D 240.06	Standart Dissecting Forcep, 25 cm
4	2	D 360.07	Standart Tissue Forcep, 25 cm
5	1	E 365.02	Bozemann Uterine Forcep, 25 cm
6	1	F 355.02	Hegar-Mayo Needle Holder, 20.5 cm
7	2	F 357.01	Hegar Needle Holder, HM, 24.5 cm
8	6	G 431.02	Rochester-Pean Haemostatic Forcep, Curved, 20 cm
9	2	K 660.04	Deaver Retractor, 75 mm, 30 cm
10	1	K 660.08	Deaver Retractor, 75 mm, 32 cm
11	1	M 276.01	Sedilot Raspatorie, 15 mm, 21.5 cm
12	1	P 321.01	Luer-Stille Bone Rongeurs 22.5 cm
13	1	P 376.01	Liston Bone Cutting Forceps, 28 cm
14	1	Y 290.05	Wire Basket, 405x255x50 mm
15	1	Y 210.10	3/4 Size Container,Basic Model, 465x280x100 mm

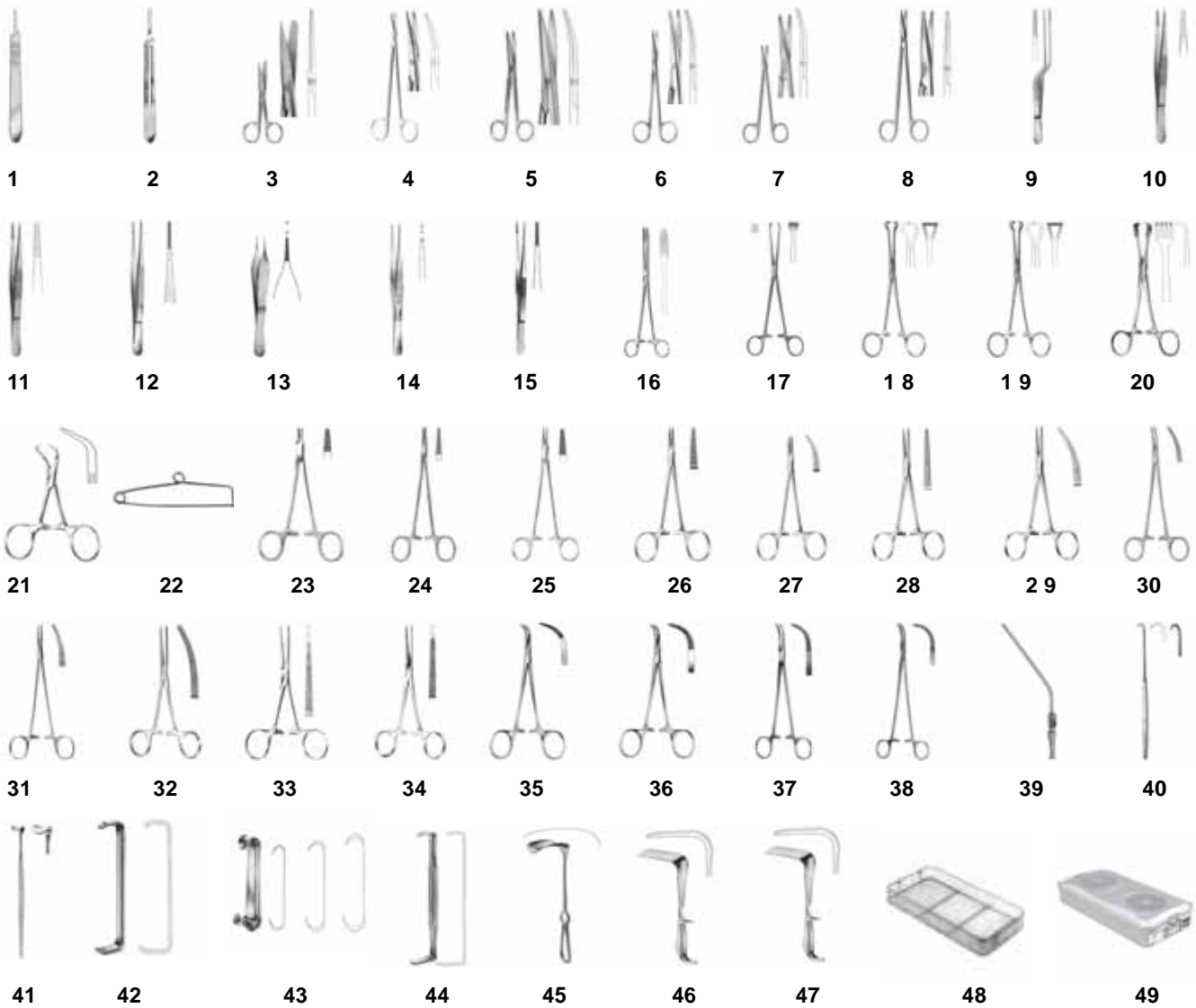

No	Quantity	Code	Description
1	1	B 030.01	Scalpel Handle 3 no, 13.5 cm
2	2	B 040.01	Scalpel Handle 4 no, 13.5 cm
3	2	C 310.03	Surgical Scissors, Straight, 14.5 cm
4	1	C 416.01	Toennis-Adson Dissecting Scissors, Curved, 17.5 cm
5	2	C 731.00	Mayo-Lexer Dissecting Scissors, Curved, 16.5 cm
6	1	C 753.00	Baby-Metzenbaum Dissecting Scissors, Curved, 14.5 cm
7	1	C 756.02	Metzenbaum Dissecting Scissors, Curved, 20 cm
8	1	C 763.00	Metzenbaum Dissecting Scissors, Straight, 18 cm
9	1	D 147.00	Lucae Forcep, Bayonet-Shaped, 14 cm
10	1	D 225.00	Dissecting Forcep, Straight, 11.5 cm
11	2	D 225.02	Dissecting Forcep, Straight, 14.5 cm
12	1	D 262.00	De Bakey Atraumatic Forcep, 2 mm, 15 cm
13	1	D 324.00	Adson Delicate Tissue Forcep, 12 cm
14	2	D 361.02	Tissue Forcep, Straight, 14.5 cm
15	1	D 512.00	Dissecting Forcep, HM, 20 cm
16	2	E 054.00	Maier Sponge and Dressing Forcep, Straight, 26.5 cm
17	2	E 150.00	Allis Tissue Grasping Forcep, 15.5 cm
18	1	E 174.00	Babcock Organ and Tissue Grasping Forcep, 16 cm
19	1	E 174.01	Babcock Organ and Tissue Grasping Forcep, 21.5 cm
20	1	E 202.00	Braun Organ and Tissue Grasping Forcep, 15.5 cm
21	10	E 430.01	Backhaus Towel Clamp, 11 cm
22	2	E 481.00	Mayo Safety Pin, 14 cm
23	2	F 333.00	Crile-Wood Needle Holder, HM, 14.5 cm
24	2	F 346.00	De Bakey Needle Holder, 18 cm
25	2	F 355.02	Hegar-Mayo Needle Holder, 20.5 cm
26	8	G 214.00	Halsted-Mosquito Delicate Haemostatic Forcep, Straight, 14 cm
27	15	G 215.00	Halsted-Mosquito Delicate Haemostatic Forcep, Curved, 12.5 cm
28	8	G 240.00	Crile Delicate Haemostatic Forcep, Straight 14 cm
29	5	G 241.00	Crile Delicate Haemostatic Forcep, Curved 14 cm
30	1	G 275.00	Nissen Delicate Haemostatic Forcep, Curved, 16 cm
31	1	G 281.00	Halsted Delicate Haemostatic Forcep, Curved, 18.5 cm
32	1	G 431.04	Rochester-Pean Haemostatic Forcep, Curved, 24 cm
33	4	G 440.01	Kocher Haemostatic Forcep, Straight, 13 cm
34	4	G 448.02	Kocher-Ochsner Haemostatic Forcep, Straight, 1x2 teeth 20 cm
35	2	G 616.00	Baby-Mixter Ligature Forcep, Curved, 14 cm
36	2	G 616.01	Baby-Mixter Ligature Forcep, Curved, 18 cm
37	2	G 620.00	Overholt-Geissendoerfer Dissecting Forcep, 19.5 cm
38	2	G 654.00	Mixter Ligature Forcep, Curved, 23 cm
39	1	J 215.04	Fergusson Suction Tube, Ø 3 mm, 11 cm
40	4	K 170.00	Retractor, Large, Sharp, 16.5 cm
41	2	K 263.00	Cushing Retractor, 10x13 mm, 20.5 cm
42	2	K 310.00	Farabeuf Retractor, 12.5 cm
43	2	K 325.00	Roux Retractor, Complete, 16.5 cm
44	2	K 342.00	Us.Army Retractor, 22 cm
45	1	K 605.04	Kocher Retractor, 80x42 mm, 25 cm
46	1	K 705.03	Doyen Abdominal Retractor, 35x122 mm, 24 cm
47	1	K 705.09	Doyen Abdominal Retractor, 60x122 mm, 24 cm
48	1	Y 190.07	Wire Basket, 485x255x70 mm
49	1	Y 110.10	1/1Size Container,Basic Model, 580x280x100 mm

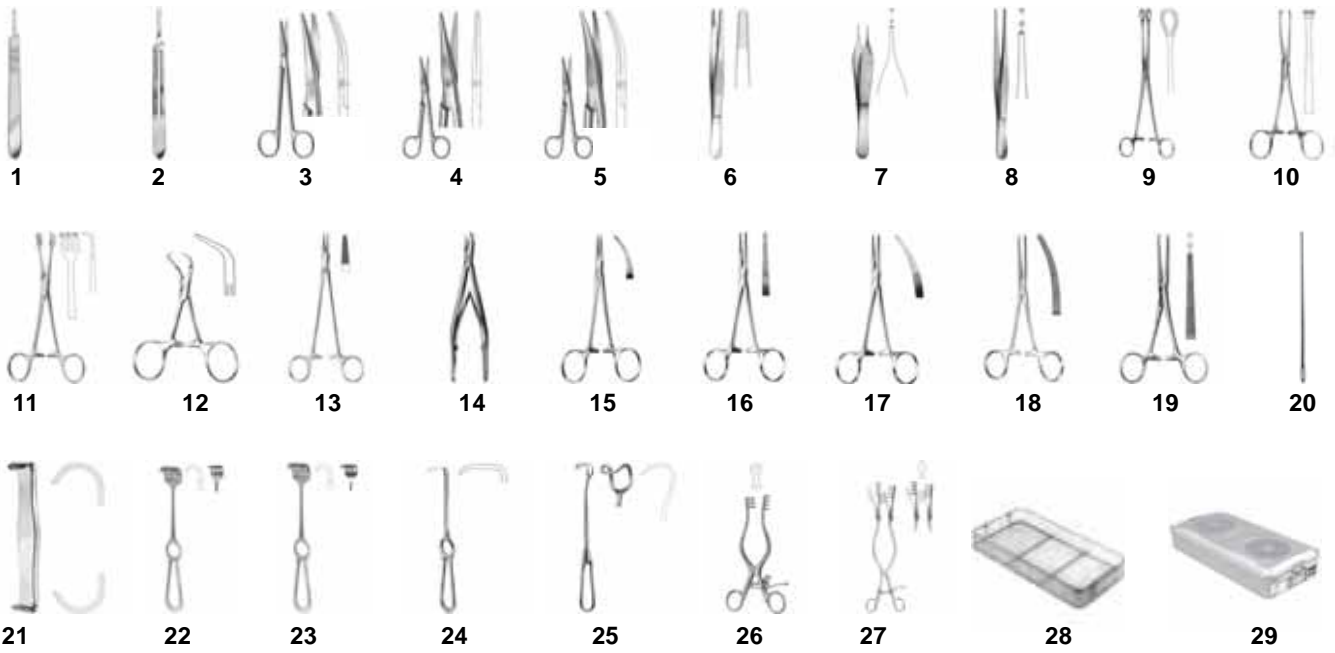

No	Quantity	Code	Description
1	1	B 030.01	Scalpel Handle 3 no, 13.5 cm
2	1	B 040.01	Scalpel Handle 4 no, 13.5 cm
3	1	C 421.01	Metzenbaum Dissecting Scissors, Curved, 18 cm
4	1	C 442.01	Mayo Stille Surgical Scissors, Straight, 17 cm
5	1	C 443.01	Mayo Stille Surgical Scissors, Curved, 17 cm
6	2	D 240.02	Standart Dissecting Forcep, 14.5 cm
7	2	D 323.00	Adson Delicate Tissue Forcep, 12 cm
8	2	D 360.03	Standart Tissue Forcep, 14.5 cm
9	4	E 086.00	Foerster-Ballenger Organ and Tissue Forcep, Straight, 24 cm
10	12	E 144.00	Allis Tissue Grasping Forcep, 5x6 teeth, 15.5 cm
11	6	E 201.00	Lahey Organ and Tissue grasping forceps, 15.5 cm
12	12	E 430.00	Backhaus Towel Clamp, 9 cm
13	4	F 355.00	Hegar-Mayo Needle Holder, 15 cm
14	2	F 620.00	Michel Clip Applying Forceps 12.5 cm
15	24	G 207.00	Micro-Halsted Delicate Haemostatic Forcep, Curved, 12.5 cm
16	12	G 234.00	Kelly Delicate Haemostatic Forcep, Straight 14 cm
17	12	G 235.00	Kelly Delicate Haemostatic Forcep, Curved 14 cm
18	12	G 431.00	Rochester-Pean Haemostatic Forcep, Curved, 16 cm
19	6	G 444.00	Kocher Haemostatic Forcep, Straight, 15 cm
20	1	J 035.00	Probe, Ø 2.5 mm 14.5 cm
21	1	K 317.00	Parker Retractor 18 cm
22	2	K 432.02	Volkman Retractor, 9x19 mm, 22 cm
23	2	K 433.02	Vollkman Retractor, Blunt, 8x19 mm. 22 cm
24	2	K 451.01	Langenbeck Retractor, 28x10 mm, 21 cm
25	1	K 481.00	Greene Retractor, 28 x 20 mm 22.5 cm
26	1	L 313.00	Waitlaner Self-Retaining Retractor, Blunt, 16.5 cm
27	1	L 371.02	Beckmann-Adson Self Retaining Retractor, Semi Sharp, 31 cm
28	1	Y 190.07	Wire Basket, 485x255x70 mm
29	1	Y 110.10	1/1Size Container,Basic Model, 580x280x100 mm



1



2



3



4



5



6



7



8



9



10



11



12



13



14



15



16



17



18



19



20



21



22



23



No	Quantity	Code	Description
1	1	B 030.01	Scalpel Handle 3 no, 13.5 cm
2	2	B 040.01	Scalpel Handle 4 no, 13.5 cm
3	1	C 310.03	Surgical Scissors, Straight, 14.5 cm
4	2	C 421.00	Metzenbaum Dissecting Scissors, Curved, 14.5 cm
5	1	C 442.01	Mayo Stille Surgical Scissors, Straight, 17 cm
6	1	C 443.01	Mayo Stille Surgical Scissors, Curved, 17 cm
7	1	D 240.02	Standart Dissecting Forcep, 14.5 cm
8	1	D 240.05	Standart Dissecting Forcep, 20 cm
9	1	D 360.03	Standart Tissue Forcep, 14.5 cm
10	1	D 360.06	Standart Tissue Forcep, 20 cm
11	6	E 086.00	Foerster-Ballenger Organ and Tissue Forcep, Straight, 24 cm
12	12	E 144.00	Allis Tissue Grasping Forcep, 5x6 teeth, 15.5 cm
13	12	E 430.02	Backhaus Towel Clamp, 13.5 cm
14	4	F 355.00	Hegar-Mayo Needle Holder, 15 cm
15	12	G 207.00	Micro-Halsted Delicate Haemostatic Forcep, Curved, 12.5 cm
16	12	G 241.00	Crile Delicate Haemostatic Forcep, Curved, 14 cm
17	6	G 431.00	Rochester-Pean Haemostatic Forcep, Curved, 16 cm
18	6	G 438.00	Rochester—Ochsner Haemostatic Forcep, Straight, 14 cm
19	1	J 437.00	Pool Suction Tube, Olive Ø 6.5-9.5 mm, Ø 7 mm, 22.5 cm
20	1	K 342.00	Us.Army Retractor, 22 cm
21	1	K 432.02	Volkman Retractor, 9x19 mm, 22 cm
22	2	K 491.00	Richardson Retractor, 47x21 24 cm
23	2	K 492.00	Kelly Retractor, 64x54 mm, 26 cm
24	1	Y 290.07	Wire Basket, 405x255x70 mm
25	1	Y 210.10	3/4 Size Container, Basic Model, 465x280x100 mm

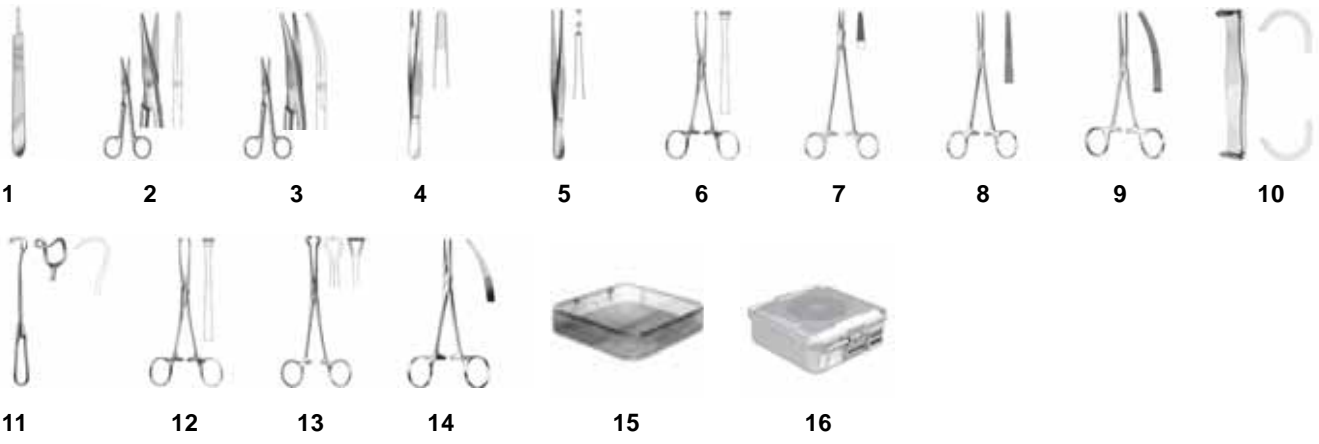

No	Quantity	Code	Description
1	1	B 030.01	Scalpel Handle 3 no, 13.5 cm
2	1	C 442.01	Mayo Stille Surgical Scissors, Straight, 17 cm
3	1	C 443.01	Mayo Stille Surgical Scissors, Curved, 17 cm
4	1	D 240.02	Standart Dissecting Forcep, 14.5 cm
5	2	D 360.03	Standart Tissue Forcep, 14.5 cm
6	6	E 144.00	Allis Tissue Grasping Forcep, 5x6 teeth, 15.5 cm
7	1	F 355.01	Hegar-Mayo Needle Holder, 18 cm
8	6	G 264.00	Crile Delicate Haemostatic Forcep, Straight, 16 cm
9	6	G 431.00	Rochester-Pean Haemostatic Forcep, Curved, 16 cm
10	1	K 317.00	Parker Retractor 18 cm
11	2	K 481.00	Greene Retractor, 28 x 20 mm 22.5 cm
12	6	E 144.00	Allis Tissue Grasping Forcep, 5x6 teeth, 15.5 cm
13	6	E 174.00	Babcook Organ and Tissue Grasping Forcep, 16 cm
14	24	G 235.00	Kelly Delicate Haemostatic Forcep, Curved 14 cm
15	1	Y 390.07	Wire Basket, 255x245x70 mm
16	1	Y 310.10	1/2 Size Container, 285x280x100 mm



1



2



3



4



5



6



7



8



9



10



11



12

No	Quantity	Code	Description
1	2	B 030.01	Scalpel Handle 3 no, 13.5 cm
2	1	C 443.00	Mayo-Stillie Surgical Scissors,Curved, 14 cm
3	1	D 360.03	Standart Tissue Forcep, 14.5 cm
4	3	E 086.00	Foerster-Ballenger Organ and Tissue Forcep, Straight, 24 cm
5	2	E 144.00	Allis Tissue Grasping Forcep, 5x6 teeth, 15.5 cm
6	4	E 430.02	Backhaus Towel Clamp, 13.5 cm
7	1	F 325.00	Halsey Needle Holder, HM, 13 cm
8	2	G 207.00	Micro-Halsted Delicate Haemostatic Forcep, Curved, 12.5 cm
9	2	G 431.00	Rochester-Pean Haemostatic Forcep, Curved, 16 cm
10	1	J 035.00	Probe, Ø 2.5 mm 14.5 cm
11	1	Y 390.03	Wire Basket, 255x245x30mm
12	1	Y 310.08	Flat Container, 285x280x85 mm

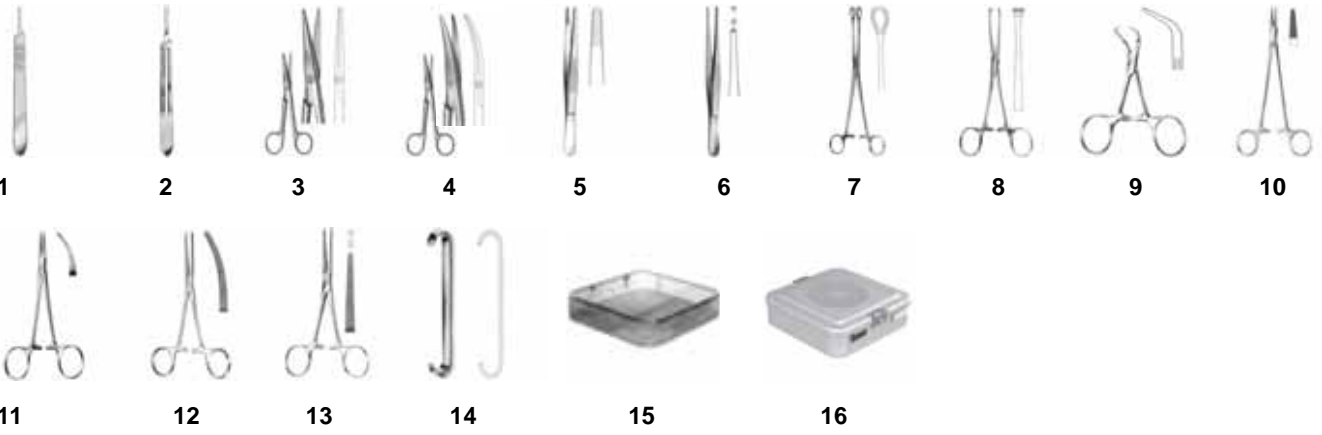

No	Quantity	Code	Description
1	2	B 030.01	Scalpel Handle 3 no, 13.5 cm
2	2	B 040.01	Scalpel Handle 4 no, 13.5 cm
3	1	C 442.00	Mayo-Stille Surgical Scissors, Straight, 14 cm
4	1	C 443.00	Mayo-Stille Surgical Scissors, Curved, 14 cm
5	2	D 240.02	Standart Dissecting Forcep, 14.5 cm
6	2	D 360.03	Standart Tissue Forcep, 14.5 cm
7	2	E 086.00	Foerster-Ballenger Organ and Tissue Forcep, Straight, 24 cm
8	6	E 144.00	Allis Tissue Grasping Forcep, 5x6 teeth, 15.5 cm
9	6	E 430.02	Backhaus Towel Clamp, 13.5 cm
10	2	F 355.00	Hegar-Mayo Needle Holder, 15 cm
11	12	G 207.00	Micro-Halsted Delicate Haemostatic Forcep, Curved, 12.5 cm
12	6	G 431.00	Rochester-Pean Haemostatic Forcep, Curved, 16 cm
13	2	G 438.00	Rochester—Ochsner Haemostatic Forcep, Straight, 14 cm
14	1	K 314.00	Parker Retractor, 13.5 cm
15	1	Y 390.03	Wire Basket, 255x245x30mm
16	1	Y 310.08	Flat Container, 285x280x85 mm

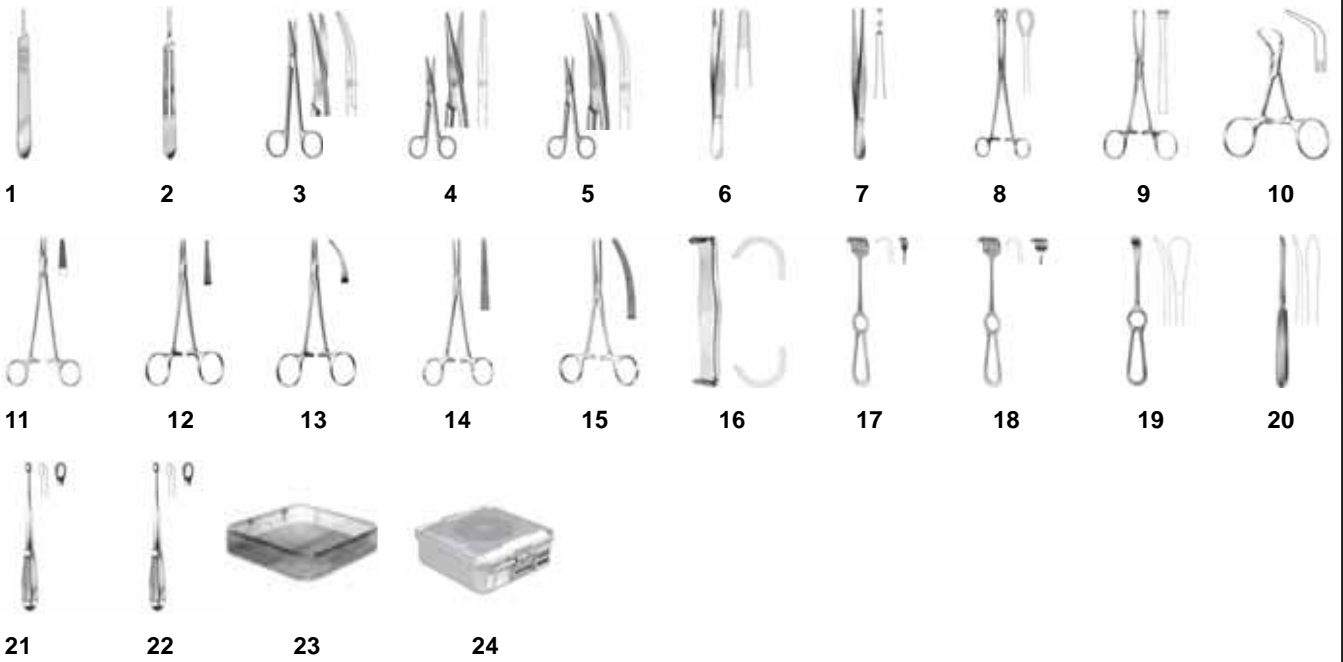

No	Quantity	Code	Description
1	2	B 030.01	Scalpel Handle 3 no, 13.5 cm
2	2	B 040.01	Scalpel Handle 4 no, 13.5 cm
3	1	C 421.01	Metzenbaum Dissecting Scissors, Curved, 18 cm
4	1	C 442.01	Mayo Stille Surgical Scissors, Straight, 17 cm
5	1	C 443.01	Mayo Stille Surgical Scissors, Curved, 17 cm
6	2	D 240.02	Standart Dissecting Forcep, 14.5 cm
7	2	D 360.03	Standart Tissue Forcep, 14.5 cm
8	6	E 086.00	Foerster-Ballenger Organ and Tissue Forcep, Straight, 24 cm
9	6	E 144.00	Allis Tissue Grasping Forcep, 5x6 teeth, 15.5 cm
10	12	E 430.02	Backhaus Towel Clamp, 13.5 cm
11	2	F 355.00	Hegar-Mayo Needle Holder, 15 cm
12	6	G 206.00	Micro-Halsted Delicate Haemostatic Forcep, Straight, 12.5 cm
13	12	G 207.00	Micro-Halsted Delicate Haemostatic Forcep, Curved, 12.5 cm
14	6	G 264.00	Crile Delicate Haemostatic Forcep, Straight, 16 cm
15	6	G 431.00	Rochester-Pean Haemostatic Forcep, Curved, 16 cm
16	1	K 317.00	Parker Retractor 18 cm
17	1	K 432.00	Volkman Retractor, Sharp, 9x8 mm, 22 cm
18	2	K 433.02	Vollkman Retractor, Blunt, 8x19 mm. 22 cm
19	1	M 276.01	Sedilot Raspatorie, 15 mm, 21.5 cm
20	1	M 341.01	Langenbeck Bone Level, 8 mm, 19.5 cm
21	1	N 202.03	Hibbs-Spratt Bone Curette, 3.5 mm, 20 cm
22	2	N 202.04	Hibbs-Spratt Bone Curette, 4 mm, 20 cm
23	1	Y 390.05	Wire Basket, 255x245x50 mm
24	1	Y 310.10	1/2 Size Container, Basic Model, 285x280x100 mm



1



2



3



4



5



6



7



8



9



10



11



12



13



14



15



16



17



18



19



20



21



22

No	Quantity	Code	Description
1	1	B 030.01	Scalpel Handle 3 no, 13.5 cm
2	1	B 040.01	Scalpel Handle 4 no, 13.5 cm
3	1	C 224.00	Delicate Scissors, Straight, 11.5 cm
4	1	C 310.03	Surgical Scissors, Straight, 14.5 cm
5	1	C 421.01	Metzenbaum Dissecting Scissors, Curved, 18 cm
6	1	C 442.00	Mayo-Stille Surgical Scissors, Straight, 14 cm
7	1	C 443.00	Mayo-Stille Surgical Scissors, Curved, 14 cm
8	2	D 240.02	Standart Dissecting Forcep, 14.5 cm
9	2	D 323.00	Adson Delicate Tissue Forcep, 12 cm
10	2	D 360.03	Standart Tissue Forcep, 14.5 cm
11	4	E 086.00	Foerster-Ballenger Organ and Tissue Forcep, Straight, 24 cm
12	4	E 144.00	Allis Tissue Grasping Forcep, 5x6 teeth, 15.5 cm
13	12	E 430.02	Backhaus Towel Clamp, 13.5 cm
14	2	F 328.00	Baby-Crile-wood Needle Holder, HM, 15 cm
15	4	G 206.00	Micro-Halsted Delicate Haemostatic Forcep, Straight, 12.5 cm
16	2	G 207.00	Micro-Halsted Delicate Haemostatic Forcep, Curved, 12.5 cm
17	6	G 264.00	Crile Delicate Haemostatic Forcep, Straight, 16 cm
18	2	G 431.00	Rochester-Pean Haemostatic Forcep, Curved, 16 cm
19	1	J 035.00	Probe, Ø 2.5 mm 14.5 cm
20	2	K 134.00	Cottle Dura Hook, 16 cm
21	1	Y 390.05	Wire Basket, 255x245x50 mm
22	1	Y 310.10	1/2 Size Container, Basic Model, 285x280x100 mm



1



2



3



4



5



6



7



8



9



10



11



12

No	Quantity	Code	Description
1	1	B 030.01	Scalpel Handle, 3 no, 13.5 cm
2	1	C 311.03	Surgical Scissors, Curved, 14.5 cm
3	1	D 149.00	Gruenwald Forcep, Bayonet-Shaped, 20 cm
4	1	D 360.03	Tissue Forcep, 14.5 cm
5	1	E 144.00	Allis Tissue Grasping Forcep, 5x6 teeth, 15.5 cm
6	1	G 206.00	Micro-Halsted Delicate Haemostatic Forcep, Straight, 12.5 cm
7	1	J 035.00	Probe, Ø 2.5 mm 14.5 cm
8	2	J 055.02	Farrel Cotton Applicator, Spiral, Ø 1.2 mm, 16 cm
9	1	J 217.01	Frazier Suction Tube, Ø 3 mm, 19 cm
10	1	R 360.04	Weil-Blakesley Rongeurs, 5.8 mm, 12 cm
11	1	Y 390.05	Wire Basket, 255x245x50 mm
12	1	Y 310.08	Flat Container, 285x280x85 mm



1



2



3



4



5



6



7



8



9



10



11



12



13



14



15

No	Quantity	Code	Description
1	1	B 032.00	Scalpel Handle 3 no, 16.5 cm
2	1	C 250.00	Joseph Delicate Scissors, Straight,Sharp, 15 cm
3	1	C 251.00	Joseph Delicate Scissors, Curved,Sharp, 15 cm
4	1	D 360.03	Tissue Forcep, 14.5 cm
5	2	E 147.01	Allis Tissue Grasping Forcep, 5x6 teeth, 19 cm
6	4	E 430.00	Backhaus Towel Clamp, 9 cm
7	2	F 328.00	Baby-Crile-wood Needle Holder, HM, 15 cm
8	4	G 460.01	Schmidt Haemostatic Forcep, 18.5 cm
9	1	J 301.00	Yankauer Suction Tube, Ø 2 mm 28.5 cm
10	1	K 589.01	Wieder Tongue Depressor, 15 cm
11	1	L 152.01	Whitehead-Jennings Mouth Gag, 11 cm
12	1	M 205.02	Hurd Raspatorie, 6 mm, 21.5 cm
13	1	R 347.01	Hartmann Rongeur, 12 cm
14	1	Y 390.05	Wire Basket, 255x245x50 mm
15	1	Y 310.08	Flat Container, 285x280x85 mm



1



2



3



4



5



6



7



8



9



10



11



12



13



14



15



16



17



18



19



Cervical or Scalenus Lymph Node Biopsy Set Major Basic Instrument Tray

No	Quantity	Code	Description
1	2	B 030.01	Scalpel Handle 3 no, 13.5 cm
2	1	C 310.03	Surgical Scissors, Straight, 14.5 cm
3	1	C 421.01	Metzenbaum Dissecting Scissors, Curved, 18 cm
4	1	C 442.01	Mayo Stille Surgical Scissors, Straight, 17 cm
5	1	C 443.01	Mayo Stille Surgical Scissors, Curved, 17 cm
6	2	D 240.02	Standart Dissecting Forcep, 14.5 cm
7	2	D 360.03	Standart Tissue Forcep, 14.5 cm
8	2	E 086.00	Foerster-Ballenger Organ and Tissue Forcep, Straight, 24 cm
9	4	E 144.00	Allis Tissue Grasping Forcep, 5x6 teeth, 15.5 cm
10	6	E 430.00	Backhaus Towel Clamp, 9 cm
11	2	F 355.00	Hegar-Mayo Needle Holder, 15 cm
12	12	G 207.00	Micro-Halsted Delicate Haemostatic Forcep, Curved, 12.5 cm
13	2	G 431.00	Rochester-Pean Haemostatic Forcep, Curved, 16 cm
14	2	K 107.00	Adson Nerve Hook, Sharp, Ø 9 mm, 20 cm
15	2	K 274.00	Cushing Retractor, 11x14 mm, 25 cm
16	1	K 314.00	Parker Retractor, 13.5 cm
17	1	L 354.01	Weitlaner Self-Retaining Retractor, Blunt, 19.5 cm,
18	1	Y 390.05	Wire Basket, 255x245x50 mm
19	1	Y 310.08	Flat Container, 285x280x85 mm

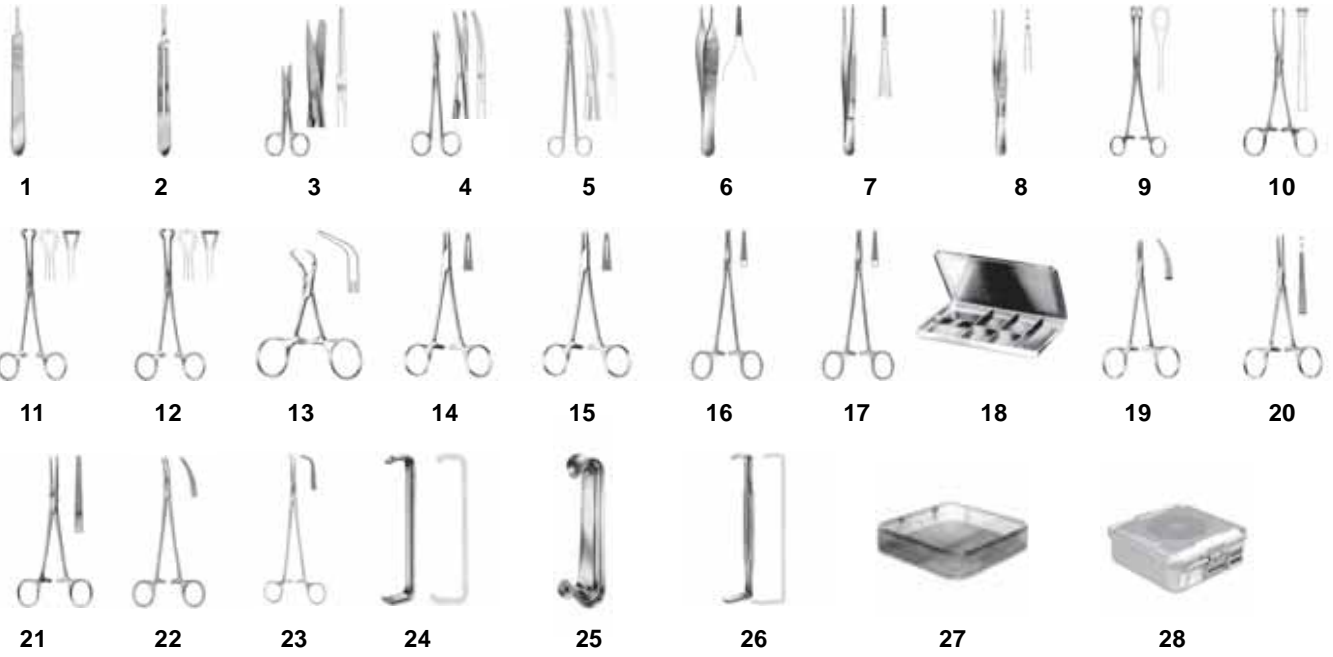

No	Quantity	Code	Description
1	1	B 030.01	Scalpel Handle 3 no, 13.5 cm
2	1	B 040.01	Scalpel Handle 4 no, 13.5 cm
3	1	C 310.02	Surgical Scissors, Straight, 13 cm
4	1	C 753.00	Baby-Metzenbaum Dissecting Scissors,Curved, 14.5 cm
5	1	C 766.00	Metzenbaum Dissecting Scissors, HM, Curved, 23 cm
6	1	D 205.00	Adson Delicate Dissecting Forcep, 12 cm
7	2	D 262.00	De Bakey Atraumatic Forcep, 2 mm, 15 cm
8	2	D 361.02	Tissue Forcep, Straight, 14.5 cm
9	1	E 084.00	Foerster-Ballenger Organ and Tissue Forcep, 24 cm
10	2	E 144.00	Allis Tissue Grasping Forcep, 5x6 teeth, 15.5 cm
11	2	E 174.00	Babcook Organ and Tissue Grasping Forcep, 16 cm
12	1	E 174.01	Babcook Organ and Tissue Grasping Forcep, 21.5 cm
13	6	E 430.01	Backhaus Towel Clamp, 11 cm
14	1	F 230.01	Mayo-Hegar Needle Holder, 18 cm
15	1	F 230.02	Mayo-Hegar Needle Holder, 20 cm
16	1	F 346.00	De Bakey Needle Holder, 18 cm
17	1	F 346.01	De Bakey Needle Holder, 18 cm
18	1	F 954.00	Needle Cases, 150x90x10 mm
19	10	G 215.00	Halsted-Mosquito Delicate Haemostatic Forcep, Curved, 12.5 cm
20	4	G 244.00	Crile Delicate Haemostatic Forcep, Straight, 14 cm
21	4	G 260.00	Rankin Delicate Haemostatic Forcep, Straight, 16 cm
22	1	G 275.00	Nissen Delicate Haemostatic Forcep, Curved, 16 cm
23	1	G 644.02	Gemini Dissecting Forcep, 18 cm
24	2	K 310.00	Farabeuf Retractor, 12.5 cm
25	1	K 325.00	Roux Retractor, Complete, 16.5 cm
26	2	K 342.00	Us.Army Retractor, 22 cm
27	1	Y 390.07	Wire Basket, 255x245x70 mm
28	1	Y 310.10	1/2 Size Container, 285x280x100 mm



No	Quantity	Code	Description	MESANE SET 2
1	1	B 030.01	Scalpel Handle 3 no, 13.5 cm	
2	1	B 032.00	Scalpel Handle 3 no, 16.5 cm	
3	1	B 040.01	Scalpel Handle 4 no, 13.5 cm	
4	1	C 310.03	Surgical Scissors, Straight, 14.5 cm	
5	2	C 756.02	Metzenbaum Dissecting Scissors, Curved, 20 cm	
6	1	C 761.00	Nelson-Metzenbaum(Mc Indore) Scissors, Curved, 23 cm	
7	1	C 780.00	Ligature Scissors, One Jaw Serrated, 18 cm	
8	1	C 780.02	Ligature Scissors, One Jaw Serrated, 23 cm	
9	1	D 240.02	Standart Dissecting Forcep, 14.5 cm	
10	1	D 262.00	De Bakey Atraumatic Forcep, 2 mm, 15 cm	
11	2	D 262.01	De Bakey Atraumatic Forcep, 2 mm, 20 cm	
12	2	D 262.02	De Bakey Atraumatic Forcep, 2 mm, 24 cm	
13	1	D 360.02	Standart Tissue Forcep, 135 cm	
14	2	D 360.07	Standart Tissue Forcep, 25 cm	
15	2	D 361.02	Tissue Forcep, Straight, 14.5 cm	
16	1	E 054.00	Maier Sponge and Dressing Forcep, Straight, 26.5 cm	
17	2	E 130.00	Tissue Grasping Forcep, 25 cm	
18	1	E 144.00	Allis Tissue Grasping Forcep, 5x6 teeth, 15.5 cm	
19	1	E 147.01	Allis Tissue Grasping Forcep, 5x6 teeth, 19 cm	
20	1	E 150.06	Allis Tissue Grasping Forcep, 25.5 cm	
21	2	E 174.00	Babcook Organ and Tissue Grasping Forcep, 16 cm	
22	2	E 174.01	Babcook Organ and Tissue Grasping Forcep, 21.5 cm	
23	6	E 430.01	Backhaus Towel Clamp, 11 cm	
24	1	F 346.00	De Bakey Needle Holder, 18 cm	
25	1	F 346.01	De Bakey Needle Holder, 23 cm	
26	1	F 355.01	Hegar-Mayo Needle Holder, 18 cm	
27	1	F 357.00	Hegar Needle Holder, HM, 20.5 cm	
28	1	F 954.00	Needle Cases, 150x90x10 mm	
29	1	F 961.00	Needle Cases,	
30	13	G 215.00	Halsted-Mosquito Delicate Haemostatic Forcep, Curved, 12.5 cm	
31	2	G 221.00	Baby-Crile Delicate Haemostatic Forcep, Curved, 14 cm	
32	2	G 241.00	Crile Delicate Haemostatic Forcep, Curved 14 cm	
33	6	G 260.00	Rankin Delicate Haemostatic Forcep, Straight, 16 cm	
34	4	G 291.00	Halsted-Mosquito Delicate Haemostatic Forcep, Curved, 20 cm	
35	5	G 440.01	Kocher Haemostatic Forcep, Straight, 13 cm	
36	2	G 448.04	Kocher-Ochsner Haemostatic Forcep, Straight, 1x2 teeth, 24 cm	
37	1	G 449.02	Kocher-Ochsner Haemostatic Forcep, 1x2 teeth, 20 cm	
38	1	G 469.02	Guyon Kidney Clamp, 23 cm	
39	2	G 644.00	Gemini Dissecting Forcep, 13 cm	
40	2	G 651.00	Wikstroem Dissecting Forcep, 20.5 cm	
41	1	G 669.01	Zenker Dissecting Forcep, 29 cm	
42	1	G 674.01	Mixer Dissecting Forcep, 25 cm	
43	2	H 442.01	De Bakey Vascular Clamp, 80 mm, 23 cm	
44	2	K 311.00	Farabeuf Retractor, 15 cm	
45	1	K 325.00	Roux Retractor, Complete, 16.5 cm	
46	2	K 342.00	Us.Army Retractor, 22 cm	
47	1	K 700.02	Mikulicz Retractor, 121x50 mm, 25 cm	
48	1	K 700.03	Mikulicz Retractor, 147x50 mm, 25 cm	
49	1	K 702.02	Kelly Retractor, 150x39 mm, 26 cm	
50	1	K 702.03	Kelly Retractor, 150x57 mm, 26 cm	
51	1	Y 190.07	Wire Basket, 485x255x70 mm	
52	1	Y 110.10	1/2 Size Container, 580x280x100 mm	

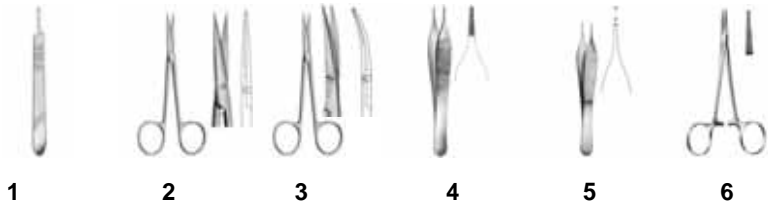

No	Quantity	Code	Description
1	1	B 030.01	Scalpel Handle 3 no, 13.5 cm
2	1	C 224.00	Delicate Scissors, Straight, 11.5 cm
3	1	C 225.00	Delicate Scissors, Curved, 11.5 cm
4	1	D 205.00	Micro Adson Delicate Dissecting Forcep, 12 cm
5	1	D 323.00	Adson Delicate Tissue Forcep, 12 cm
6	6	G 206.00	Micro-Halsted Delicate Haemostatic Forcep, Straight, 12.5 cm

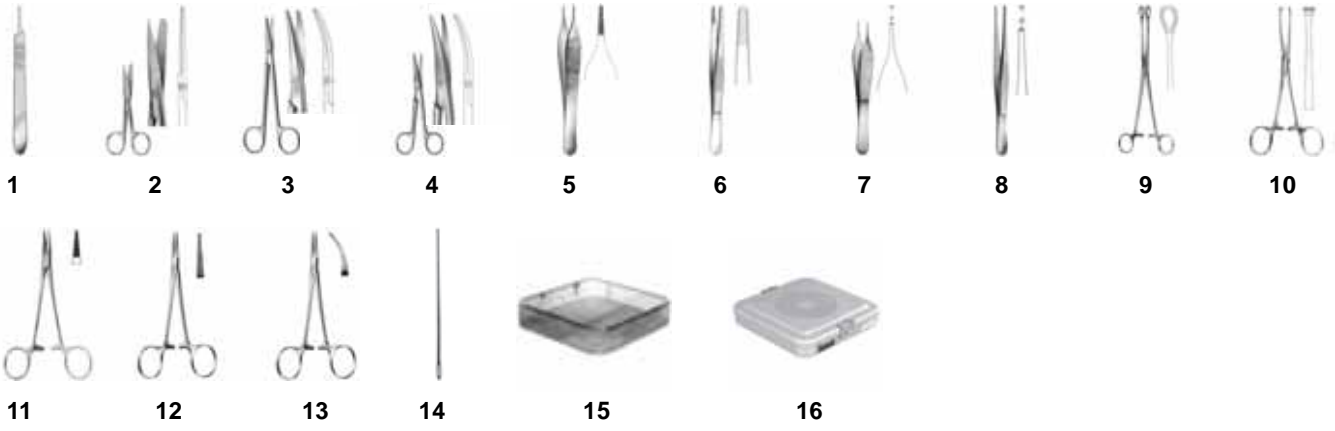

No	Quantity	Code	Description
1	1	B 030.01	Scalpel Handle 3 no, 13.5 cm
2	1	C 310.03	Surgical Scissors, Straight, 14.5 cm
3	1	C 421.01	Metzenbaum Dissecting Scissors, Curved, 18 cm
4	1	C 443.00	Mayo-Stille Surgical Scissors, Curved, 14 cm
5	1	D 205.00	Micro Adson Delicate Dissecting Forcep, 12 cm
6	1	D 240.02	Standart Dissecting Forcep, 14.5 cm
7	1	D 323.00	Adson Delicate Tissue Forcep, 12 cm
8	1	D 360.03	Standart Tissue Forcep, 14.5 cm
9	2	E 086.00	Foerster-Ballenger Organ and Tissue Forcep, Straight, 24 cm
10	4	E 144.00	Allis Tissue Grasping Forcep, 5x6 teeth, 15.5 cm
11	1	F 328.00	Baby-Crile-wood Needle Holder, HM, 15 cm
12	6	G 206.00	Micro-Halsted Delicate Haemostatic Forcep, Straight, 12.5 cm
13	6	G 207.00	Micro-Halsted Delicate Haemostatic Forcep, Curved, 12.5 cm
14	1	J 035.00	Probe, Ø 2.5 mm 14.5 cm
15	1	Y 390.03	Wire Basket, 255x245x30 mm
16	1	Y 310.05	1/2 Size Container, 285x280x100 mm



1



2



3



4



5



6



7



8



9



10



11



12



13



14



15



16



17



18



19



20

No	Quantity	Code	Description
1	2	B 030.01	Scalpel Handle 3 no, 13.5 cm
2	1	C 388.00	Stevens Dissecting Scissors, Straight, 10 cm
3	1	C 389.00	Stevens Dissecting Scissors, Curved, 10 cm
4	1	C 421.01	Metzenbaum Dissecting Scissors, Curved, 18 cm
5	1	C 442.00	Mayo-Stille Surgical Scissors, Straight, 14 cm
6	2	D 205.00	Micro Adson Delicate Dissecting Forcep, 12 cm
7	2	E 086.00	Foerster-Ballenger Organ and Tissue Forcep, Straight, 24 cm
8	6	E 144.00	Allis Tissue Grasping Forcep, 5x6 teeth, 15.5 cm
9	6	E 430.00	Backhaus Towel Clamp, 9 cm
10	2	F 328.00	Baby-Crile-wood Needle Holder, HM, 15 cm
11	6	G 206.00	Micro-Halsted Delicate Haemostatic Forcep, Straight, 12.5 cm
12	12	G 207.00	Micro-Halsted Delicate Haemostatic Forcep, Curved, 12.5 cm
13	2	G 431.00	Rochester-Pean Haemostatic Forcep, Curved, 16 cm
14	2	G 438.00	Rochester—Ochsner Haemostatic Forcep, Straight, 14 cm
15	1	J 217.02	Frazier Suction Tube, Ø 4 mm, 19 cm
16	2	K 242.00	Senn-Miller Retractor, 18x6 mm 16.5 cm
17	2	K 274.00	Cushing Retractor, 11x14 mm, 25 cm
18	2	K 433.00	Vollkman Retractor, Blunt, 8x8 mm. 22 cm
19	1	Y 390.05	Wire Basket, 255x245x50 mm
20	1	Y 310.08	Flat Container, 285x280x85 mm

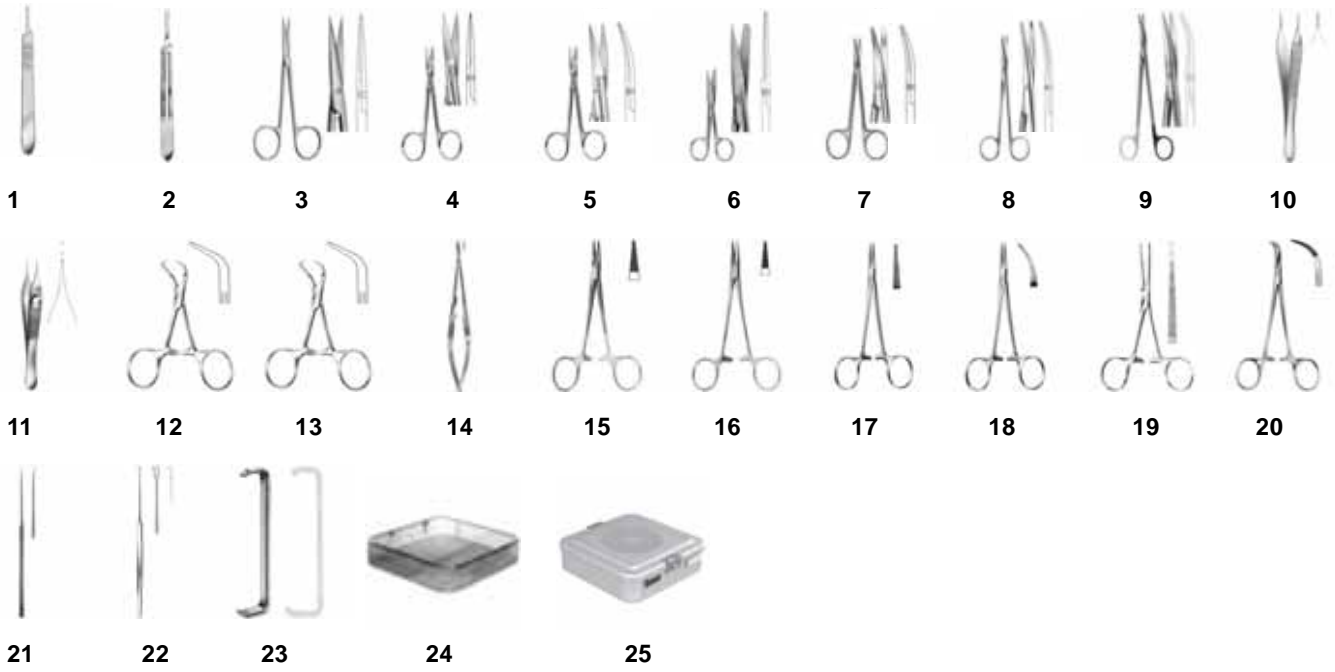

No	Quantity	Code	Description
1	1	B 030.01	Scalpel Handle 3 no, 13.5 cm
2	1	B 040.01	Scalpel Handle 4 no, 13.5 cm
3	1	C 224.00	Delicate Scissors, Straight, 11.5 cm
4	1	C 230.00	Delicate Scissors, Straight, Sharp, 11 cm
5	1	C 231.00	Delicate Scissors, Straight, Sharp, 11 cm
6	1	C 310.03	Surgical Scissors, Straight, 14.5 cm
7	1	C 751.00	Dissecting Scissors, Curved, 11.5 cm
8	1	C 753.00	Baby-Metzenbaum Dissecting Scissors, Curved, 14.5 cm
9	1	C 780.00	Ligature Scissors, One Jaw Serrated, 18 cm
10	2	D 204.00	Micro-Adson Delicate Dissecting Forcep, 12 cm
11	1	D 326.00	Adson Delicate Tissue Forcep, 12 cm
12	4	E 430.00	Backhaus Towel Clamp, 9 cm
13	2	E 430.01	Backhaus Towel Clamp, 11 cm
14	1	F 305.00	Needle Holder, With catch, 18 cm
15	1	F 325.00	Halsey Needle Holder, HM, 13 cm
16	1	F 328.00	Baby-Crile-wood Needle Holder, HM, 15 cm
17	2	G 206.00	Micro-Halsted Delicate Haemostatic Forcep, Straight, 12.5 cm
18	8	G 207.00	Micro-Halsted Delicate Haemostatic Forcep, Curved, 12.5 cm
19	4	G 440.01	Kocher Haemostatic Forcep, Straight, 13 cm
20	1	G 616.00	Baby-Mixer Ligature Forcep, Curved, 14 cm
21	1	K 127.00	Kilner Skin Hook, 16 cm
22	1	K 128.00	Freer Skin Hook, 15 cm
23	2	K 310.00	Farabeuf Retractor, 12.5 cm
24	1	Y 390.03	Wire Basket, 255x245x30 mm
25	1	Y 310.08	Flat Container, 285x280x85 mm

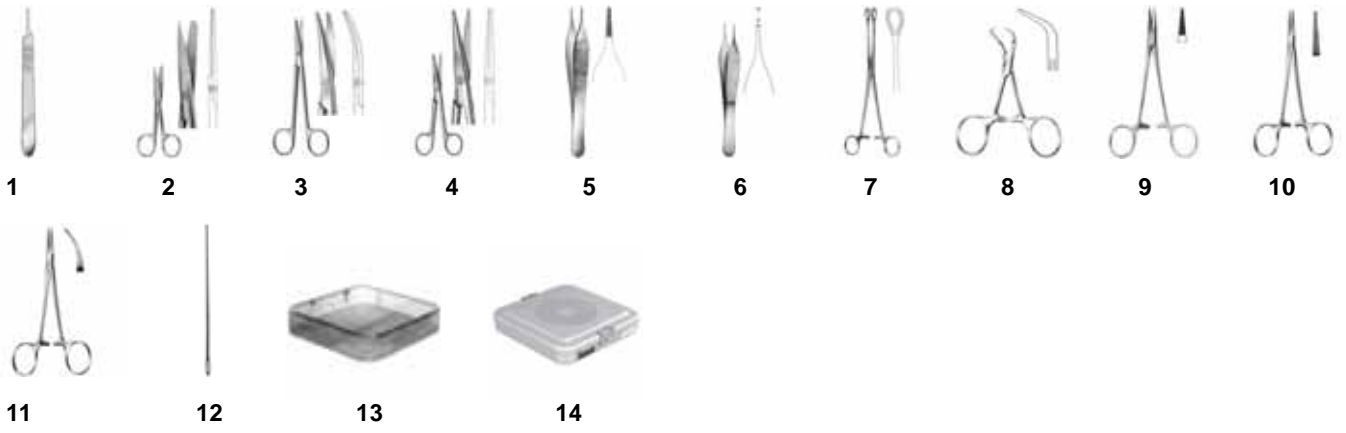

No	Quantity	Code	Description
1	1	B 030.01	Scalpel Handle 3 no, 13.5 cm
2	1	C 310.03	Surgical Scissors, Straight, 14.5 cm
3	1	C 421.01	Metzenbaum Dissecting Scissors, Curved, 18 cm
4	1	C 442.00	Mayo-Stille Surgical Scissors, Straight, 14 cm
5	1	D 205.00	Micro Adson Delicate Dissecting Forcep, 12 cm
6	1	D 323.00	Adson Delicate Tissue Forcep, 12 cm
7	2	E 086.00	Foerster-Ballenger Organ and Tissue Forcep, Straight, 24 cm
8	6	E 430.00	Backhaus Towel Clamp, 9 cm
9	1	F 328.00	Baby-Crile-wood Needle Holder, HM, 15 cm
10	4	G 206.00	Micro-Halsted Delicate Haemostatic Forcep, Straight, 12.5 cm
11	4	G 207.00	Micro-Halsted Delicate Haemostatic Forcep, Curved, 12.5 cm
12	1	J 035.00	Probe, Ø 2.5 mm 14.5 cm
13	1	Y 390.03	Wire Basket, 255x245x30 mm
14	1	Y 310.05	Flat Container, 285x280x85 mm

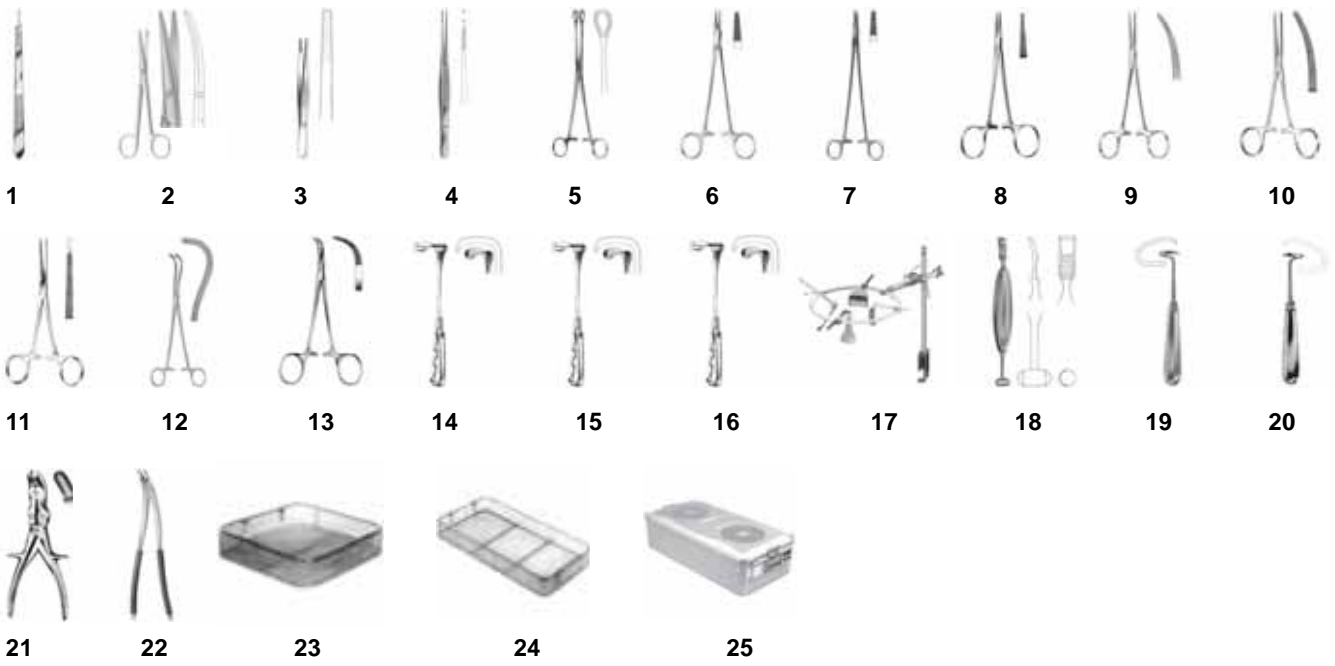

No	Quantity	Code	Description
1	1	B 030.02	Scalpel Handle 3 no, 21.5 cm
2	1	C 459.01	Mayo Surgical Scissors, Curved, 20 cm
3	21	D 240.06	Standart Dissecting Forcep, 25 cm
4	1	D 382.00	Waugh Tissue Forcep, Straight, 18 cm
5	2	E 086.00	Foerster-Ballenger Organ and Tissue Forcep, Straight, 24 cm
6	2	F 355.00	Hegar-Mayo Needle Holder, 15 cm
7	1	F 357.01	Hegar Needle Holder, HM, 24.5 cm
8	6	G 206.00	Micro-Halsted Delicate Haemostatic Forcep, Straight, 12.5 cm
9	18	G 265.00	Crile Delicate Haemostatic Forcep, Curved, 16 cm
10	6	G 431.02	Rochester-Pean Haemostatic Forcep, Curved, 20 cm
11	6	G 448.02	Kocher-Ochsner Haemostatic Forcep, Straight, 1x2 teeth 20 cm
12	2	G 468.00	Guyon Kidney Clamp, 23.5 cm
13	2	G 616.01	Baby-Mixer Ligature Forcep, Curved, 18 cm
14	2	K 490.00	Richardson Retractor, 23x20 mm 24 cm
15	2	K 490.01	Richardson Retractor, 30x29 mm 24 cm
16	2	K 490.02	Richardson Retractor, 37x37 mm 24 cm

If Chest approach is used, add for rib resection

17	1	L 620.00	Bookwalter Abdominal Retractor Set
18	1	M 285.00	Alexander Raspatorie, 12 mm, 21 cm
19	1	M 290.01	Doyen Raspatorie, 17.5 cm
20	1	M 291.02	Doyen Raspatorie, 17.5 cm
21	1	P 321.01	Luer-Stille Bone Rongeurs 22.5 cm
22	1	P 515.00	Bethune Rib Shear, 34 cm
23	1	Y 390.05	Wire Basket, 255x245x50 mm
24	1	Y 191.07	Wire Basket, 540x255x70 mm
25	2	Y 110.15	1/1 Size Container, 580x280x150 mm



1



2



3



4



5



6



7



8



9



10



Nephrotomy, Nephrostomy, Nephrolithotomy, Pyelotomy and Pyelostomy Set

No	Quantity	Code	Description
1	1	B 030.01	Scalpel Handle 3 no, 13.5 cm
2	1	C 311.03	Surgical Scissors, Curved, 14.5 cm
3	2	D 340.00	Adson-Brown Delicate Tissue Forcep, 12 cm
4	1	E 602.01	Randall Kidney Stone Forcep, 22.5 cm
5	1	E 603.01	Randall Kidney Stone Forcep, 22.5 cm
6	1	E 604.01	Randall Kidney Stone Forcep, 22.5 cm
7	1	E 605.01	Randall Kidney Stone Forcep, 22.5 cm
8	2	G 368.02	Doyen Intestinal Clamp, Elastic, Straight, 23.5 cm
9	1	Y 390.05	Wire Basket, 255x245x50 mm
10	1	Y 310.08	Flat Container, 285x280x85 mm

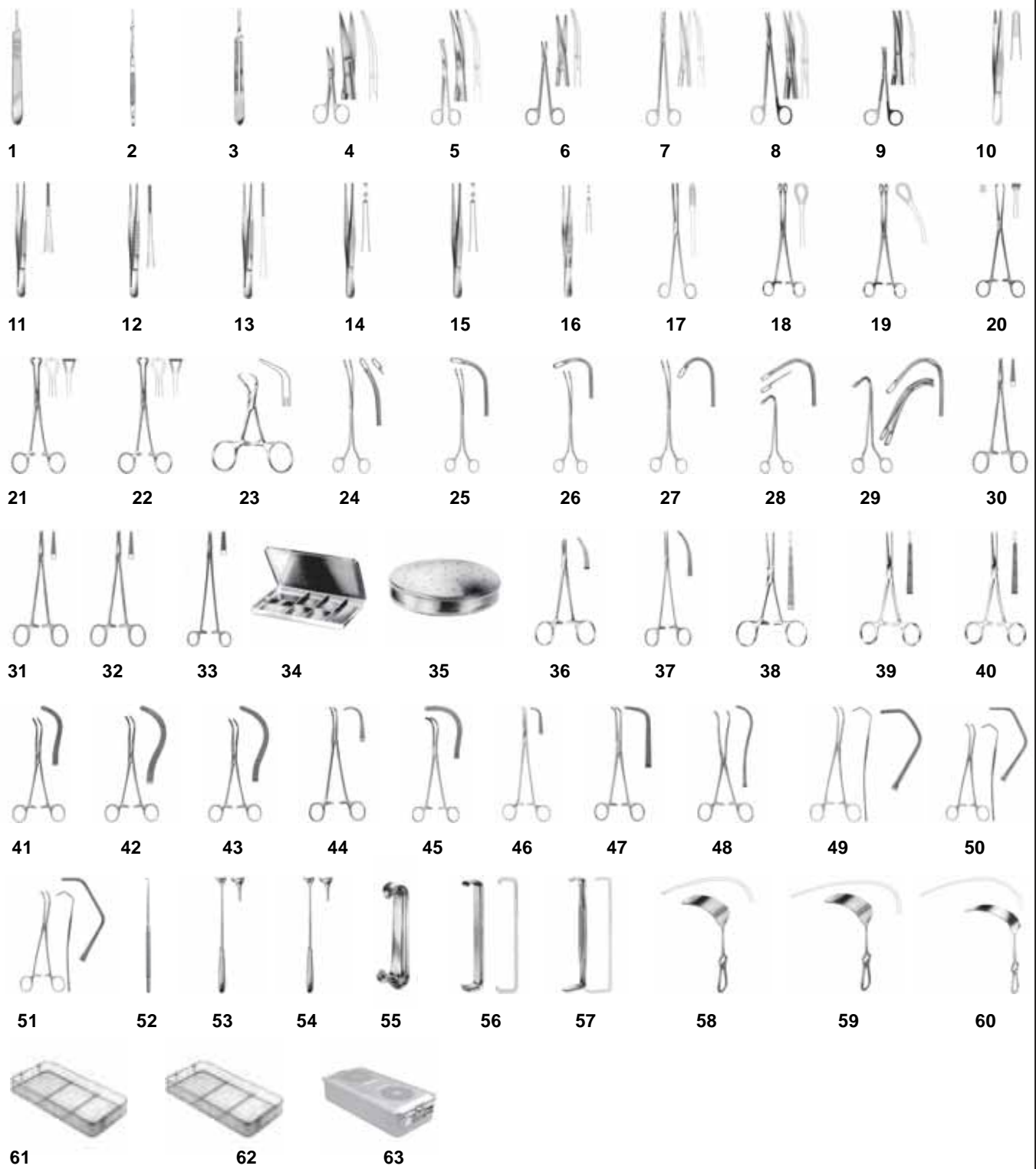

No	Quantity	Code	Description
1	1	B 030.01	Scalpel Handle 3 no, 13.5 cm
2	1	B 032.00	Scalpel Handle 3 no, 16.5 cm
3	1	B 040.01	Scalpel Handle 4 no, 13.5 cm
4	1	C 315.03	Surgical Scissors, Curved, 14.5 cm
5	1	C 455.00	Lexer Surgical Scissors, Curved, 16.5 cm
6	5	C 756.02	Metzenbaum Dissecting Scissors, Curved, 20 cm
7	1	C 761.00	Nelson-Metzenbaum(Mc Indore) Scissors, Curved, 23 cm
8	1	C 780.00	Ligature Scissors, One Jaw Serrated, 18 cm
9	1	C 781.01	Ligature Scissors, One Jaw Serrated, 14.5 cm
10	1	D 240.01	Standart Dissecting Forcep, 135 cm
11	2	D 262.00	De Bakey Atraumatic Forcep, 2 mm, 15 cm
12	2	D 262.01	De Bakey Atraumatic Forcep, 2 mm, 20 cm
13	2	D 262.02	De Bakey Atraumatic Forcep, 2 mm, 24 cm
14	2	D 360.06	Standart Tissue Forcep, 20 cm
15	2	D 360.07	Standart Tissue Forcep, 25 cm
16	2	D 361.02	Tissue Forcep, Straight, 14.5 cm
17	1	E 050.00	Maier Dressing Forceps, Straight, 26.5 cm
18	1	E 086.00	Foerster-Ballenger Organ and Tissue Forcep, Straight, 24 cm
19	1	E 087.00	Foerster-Ballenger Organ and Tissue Forcep, Curved, 24 cm
20	4	E 150.06	Allis Tissue Grasping Forcep, 25.5 cm
21	2	E 174.00	Babcook Organ and Tissue Grasping Forcep, 16 cm
22	2	E 174.01	Babcook Organ and Tissue Grasping Forcep, 21.5 cm
23	6	E 430.01	Backhaus Towel Clamp, 11 cm
24	2	E 602.01	Randall Kidney Stone Forcep, 22.5 cm
25	1	E 603.01	Randall Kidney Stone Forcep, 22.5 cm
26	2	E 604.01	Randall Kidney Stone Forcep, 22.5 cm
27	1	E 605.01	Randall Kidney Stone Forcep, 22.5 cm
28	1	E 608.01	Randall Kidney Stone Forcep, 19 cm
29	1	E 609.01	Randall Kidney Stone Forcep, 19 cm
30	1	F 346.00	De Bakey Needle Holder, 18 cm
31	1	F 346.01	De Bakey Needle Holder, 23 cm
32	1	F 346.02	De Bakey Needle Holder, 25 cm
33	1	F 357.00	Hegar Needle Holder, HM, 20.5 cm
34	1	F 954.00	Needle Cases, 150x90x10 mm
35	1	F 961.00	Needle Cases,
36	16	G 215.00	Halsted-Mosquito Delicate Haemostatic Forcep, Curved, 12.5 cm
37	6	G 291.00	Halsted-Mosquito Delicate Haemostatic Forcep, Curved, 20 cm
38	6	G 440.01	Kocher Haemostatic Forcep, Straight, 13 cm
39	1	G 448.02	Kocher-Ochsner Haemostatic Forcep, Straight, 1x2 teeth 20 cm
40	1	G 448.04	Kocher-Ochsner Haemostatic Forcep, Straight, 1x2 teeth, 24 cm
41	1	G 459.00	Pean Kidney Clamp, 19.5 cm
42	1	G 459.01	Pean Kidney Clamp, 22 cm
43	1	G 459.02	Pean Kidney Clamp, 23 cm
44	1	G 464.01	Negus Haemostatic Forcep, 19 cm
45	1	G 469.02	Guyon Kidney Clamp, 23 cm
46	2	G 644.00	Gemini Dissecting Forcep, 13 cm
47	2	G 651.00	Wikstroem Dissecting Forcep, 20.5 cm
48	1	H 442.01	De Bakey Vascular Clamp, 80 mm, 23 cm
49	1	H 570.00	De Bakey Vascular Clamp, 38x85 mm, 22 cm
50	1	H 570.01	De Bakey Vascular Clamp, 48x95 mm, 26.5 cm
51	1	H 570.02	De Bakey Vascular Clamp, 54x99 mm, 27 cm
52	2	K 107.01	Adson Nerve Hook, Blunt, Ø 9 mm, 20 cm
53	1	K 274.00	Cushing Retractor, 11x14 mm, 25 cm
54	2	K 274.02	Cushing Retractor, 15x22 mm, 25 cm
55	2	K 311.00	Farabeuf Retractor, 15 cm
56	1	K 325.00	Roux Retractor, Complete, 16.5 cm
57	2	K 342.00	Us.Army Retractor, 22 cm
58	1	K 700.02	Mikulicz Retractor, 121x50 mm, 25 cm
59	1	K 700.03	Mikulicz Retractor, 147x50 mm, 25 cm
60	1	K 702.03	Kelly Retractor, 150x57 mm, 26 cm
61	1	Y 190.03	Wire Basket, 485x255x30 mm
62	1	Y 190.07	Wire Basket, 485x255x70 mm
63	1	Y 110.13	1/1 Size Container, 580x280x135 mm

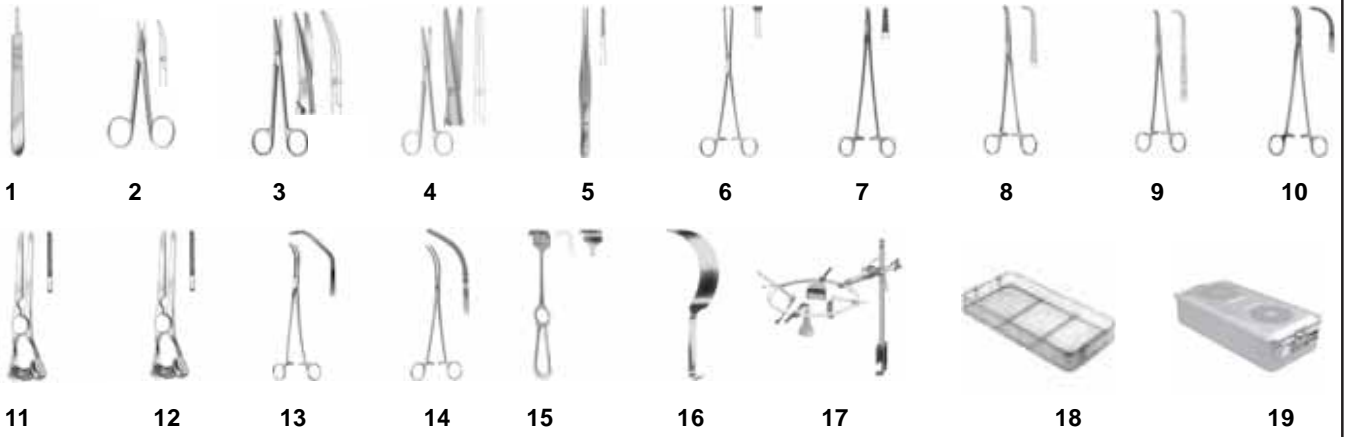

No	Quantity	Code	Description
1	1	B 030.01	Scalpel Handle 3 no, 13.5 cm
2	1	C 389.00	Stevens Dissecting Scissors, Curved, 10 cm
3	1	C 421.02	Metzenbaum Dissecting Scissors, Curved, 20 cm
4	1	C 458.01	Mayo Surgical Scissors, Straight, 20 cm
5	2	D 220.00	Cushing Dissecting Forcep, Straight, 18 cm
6	6	E 147.01	Allis Tissue Grasping Forcep, 5x6 teeth, 19 cm
7	2	F 357.01	Hegar Needle Holder, HM, 24.5 cm
8	4	G 642.01	Mini-Gemini Dissecting Forcep, 22 cm
9	4	G 642.03	Mini-Gemini Dissecting Forcep, 28 cm
10	4	G 654.00	Mixer Ligature Forcep, Curved, 23 cm
11	2	H 136.00	Glower Bulldog Clamp, Straight, 5 cm
12	2	H 136.02	Glower Bulldog Clamp, Straight, 8.5 cm
13	2	H 661.02	Satinsky Vascular Clamp, 26.5 cm
14	2	H 670.01	Crafoord Dissecting Clamp, 24 cm
15	2	K 433.03	Vollkman Retractor, Blunt, 8x29 mm. 22 cm
16	2	K 660.08	Deaver Retractor, 75 mm, 32 cm
17	1	L 620.00	Bookwalter Abdominal Retractor Set
18	1	Y 191.07	Wire Basket, 540x255x70 mm
19	1	Y 110.13	1/1 Size Container, 580x280x135 mm



1



2



3



4



5



6



7



8



9



10



11



12

No	Quantity	Code	Description
1	1	B 030.01	Scalpel Handle 3 no, 13.5 cm
2	1	C 224.00	Delicate Scissors, Straight, 11.5 cm
3	2	D 340.00	Adson-Brown Delicate Tissue Forcep, 12 cm
4	6	E 174.01	Babcock Organ and Tissue Grasping Forcep, 21.5 cm
5	1	E 602.01	Randall Kidney Stone Forcep, 22.5 cm
6	1	E 603.01	Randall Kidney Stone Forcep, 22.5 cm
7	1	E 604.01	Randall Kidney Stone Forcep, 22.5 cm
8	1	E 605.01	Randall Kidney Stone Forcep, 22.5 cm
9	12	G 207.00	Micro-Halsted Delicate Haemostatic Forcep, Curved, 12.5 cm
10	2	G 460.01	Schmidt Haemostatic Forcep, 18.5 cm
11	1	Y 390.05	Wire Basket, 255x245x50 mm
12	1	Y 310.10	1/2 Size Container, 285x280x100 mm

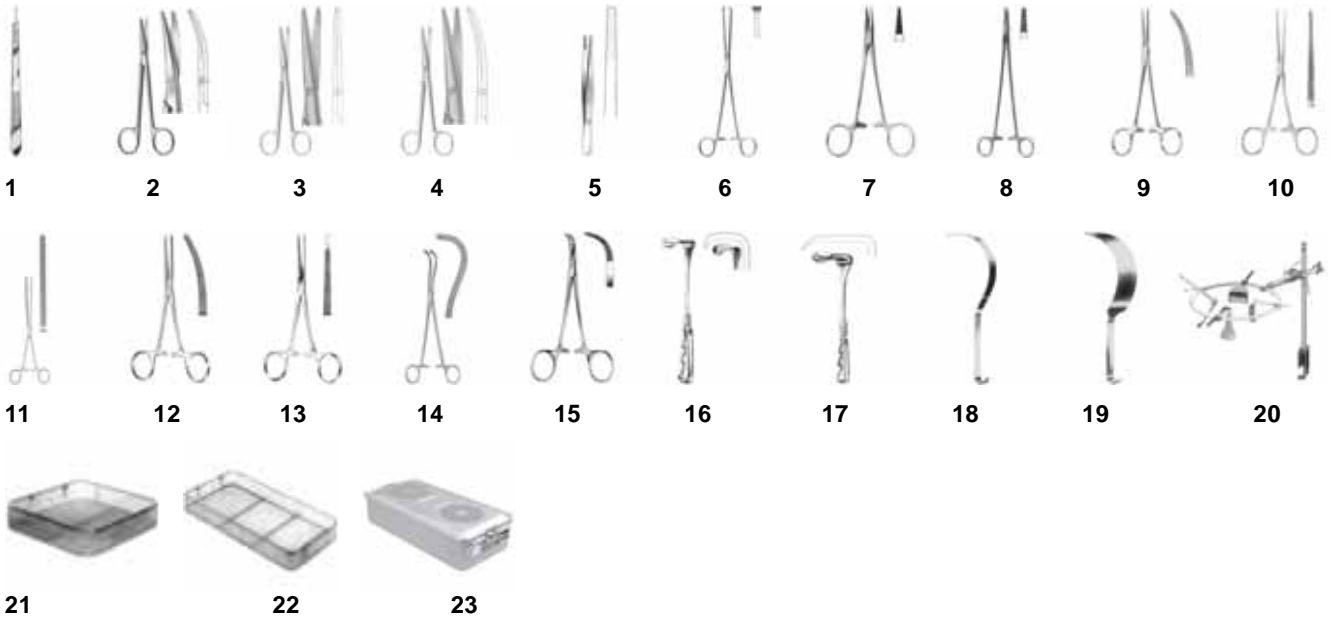

No	Quantity	Code	Description
1	1	B 030.02	Scalpel Handle 3 no, 21.5 cm
2	1	C 421.02	Metzenbaum Dissecting Scissors, Curved, 20 cm
3	1	C 458.01	Mayo Surgical Scissors, Straight, 20 cm
4	1	C 459.01	Mayo Surgical Scissors, Curved, 20 cm
5	2	D 240.06	Standart Dissecting Forcep, 25 cm
6	6	E 147.01	Allis Tissue Grasping Forcep, 5x6 teeth, 19 cm
7	2	F 328.00	Baby-Crile-wood Needle Holder, HM, 15 cm
8	2	F 357.01	Hegar Needle Holder, HM, 24.5 cm
9	12	G 265.00	Crile Delicate Haemostatic Forcep, Curved, 16 cm
10	4	G 330.00	Allen Intestinal Clamp, Straight, 15.5 cm
11	2	G 368.02	Doyen Intestinal Clamp, Elastic, Straight, 23.5 cm
12	6	G 431.02	Rochester-Pean Haemostatic Forcep, Curved, 20 cm
13	6	G 448.02	Kocher-Ochsner Haemostatic Forcep, Straight, 1x2 teeth 20 cm
14	3	G 468.00	Guyon Kidney Clamp, 23.5 cm
15	4	G 616.01	Baby-Mixter Ligature Forcep, Curved, 18 cm
16	2	K 490.00	Richardson Retractor, 23x20 mm 24 cm
17	2	K 492.01	Kelly Retractor, 70x65 mm, 26 cm
18	1	K 660.05	Deaver Retractor, 25 mm, 31.5 cm
19	2	K 660.08	Deaver Retractor, 75 mm, 32 cm
20	1	L 620.00	Bookwalter Abdominal Retractor Set
21	1	Y 390.05	Wire Basket, 255x245x50 mm
22	1	Y 191.07	Wire Basket, 540x255x70 mm
23	1	Y 110.13	1/1 Size Container, 580x280x135 mm

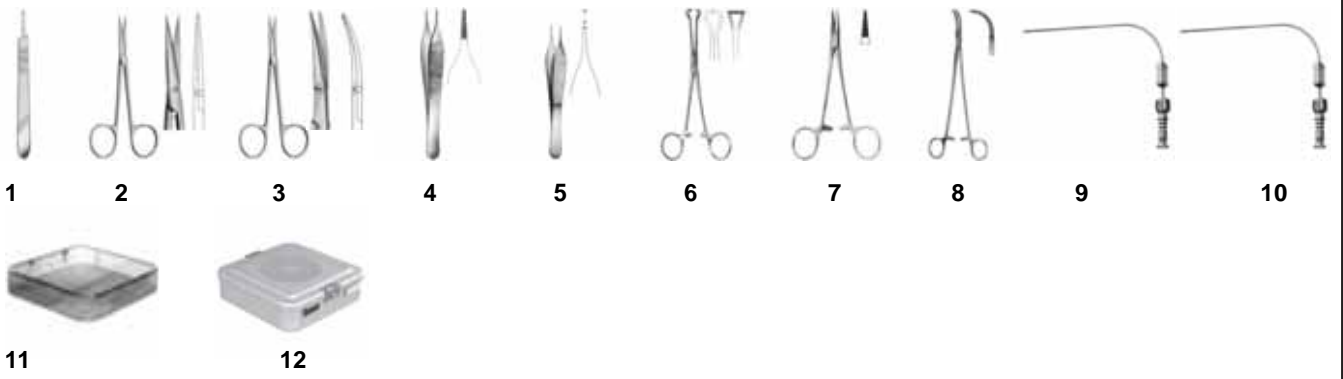

No	Quantity	Code	Description
1	1	B 030.01	Scalpel Handle 3 no, 13.5 cm
2	1	C 224.00	Delicate Scissors, Straight, 11.5 cm
3	1	C 225.00	Delicate Scissors, Curved, 11.5 cm
4	2	D 205.00	Micro Adson Delicate Dissecting Forcep, 12 cm
5	2	D 323.00	Adson Delicate Tissue Forcep, 12 cm
6	2	E 174.01	Babcock Organ and Tissue Grasping Forcep, 21.5 cm
7	2	F 328.00	Baby-Crile-wood Needle Holder, HM, 15 cm
8	2	G 654.00	Mixer Ligature Forcep, Curved, 23 cm
9	1	J 217.00	Frazier Suction Tube, Ø 2 mm, 19 cm
10	1	J 217.01	Frazier Suction Tube, Ø 3 mm, 19 cm
11	1	Y 390.05	Wire Basket, 255x245x50 mm
12	1	Y 310.08	Flat Container, 285x280x85 mm

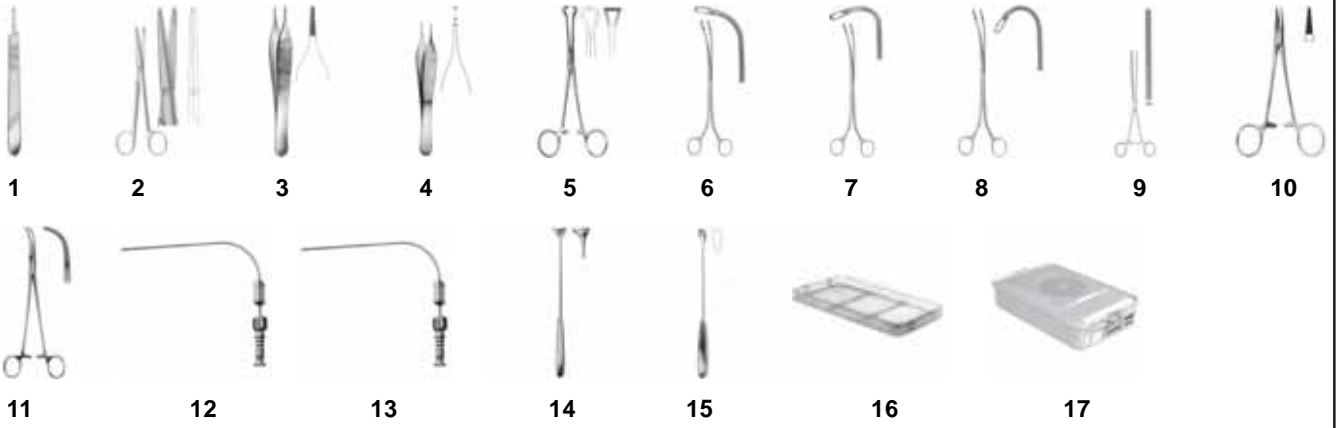

No	Quantity	Code	Description
1	1	B 030.01	Scalpel Handle 3 no, 13.5 cm
2	1	C 458.01	Mayo Surgical Scissors, Straight, 20 cm
3	1	D 205.00	Micro Adson Delicate Dissecting Forcep, 12 cm
4	1	D 323.00	Adson Delicate Tissue Forcep, 12 cm
5	4	E 174.01	Babcock Organ and Tissue Grasping Forcep, 21.5 cm
6	1	E 602.01	Randall Kidney Stone Forcep, 22.5 cm
7	1	E 603.01	Randall Kidney Stone Forcep, 22.5 cm
8	1	E 604.01	Randall Kidney Stone Forcep, 22.5 cm
9	1	E 605.01	Randall Kidney Stone Forcep, 22.5 cm
10	2	F 328.00	Baby-Crile-wood Needle Holder, HM, 15 cm
11	2	G 672.00	Lahey Dissecting Forcep, 19 cm
12	1	J 217.00	Frazier Suction Tube, Ø 2 mm, 19 cm
13	1	J 217.01	Frazier Suction Tube, Ø 3 mm, 19 cm
14	2	K 274.00	Cushing Retractor, 11x14 mm, 25 cm
15	1	N 510.10	Gourdet Uterine Scoop, Blunt, 8 mm, 28 cm
16	1	Y 290.03	Wire Basket, 405x255x30 mm
17	1	Y 210.10	3/4 Size Container, 465x280x100 mm



1



2



3



4



5



6



7



8



9



10



11



12



13



14



15



16



17



18



19

No	Quantity	Code	Description
1	1	B 030.01	Scalpel Handle 3 no, 13.5 cm
2	1	B 040.01	Scalpel Handle 4 no, 13.5 cm
3	1	C 310.03	Surgical Scissors, Straight, 14.5 cm
4	1	C 421.01	Metzenbaum Dissecting Scissors, Curved, 18 cm
5	1	C 442.01	Mayo Stille Surgical Scissors, Straight, 17 cm
6	1	C 443.01	Mayo Stille Surgical Scissors, Curved, 17 cm
7	2	D 240.02	Standart Dissecting Forcep, 14.5 cm
8	2	D 360.03	Standart Tissue Forcep, 14.5 cm
9	6	E 086.00	Foerster-Ballenger Organ and Tissue Forcep, Straight, 24 cm
10	6	E 144.00	Allis Tissue Grasping Forcep, 5x6 teeth, 15.5 cm
11	6	E 430.02	Backhaus Towel Clamp, 13.5 cm
12	2	F 355.00	Hegar-Mayo Needle Holder, 15 cm
13	6	G 241.00	Crile Delicate Haemostatic Forcep, Curved, 14 cm
14	2	G 431.00	Rochester-Pean Haemostatic Forcep, Curved, 16 cm
15	4	G 468.00	Guyon Kidney Clamp, 23.5 cm
16	2	K 432.02	Volkman Retractor, Sharp, 9x19 mm, 22 cm
17	1	L 708.00	Sims Rectal Specula, 17x77 mm, 16 cm
18	1	Y 390.07	Wire Basket, 255x245x70 mm
19	1	Y 310.10	Flat Container, 285x280x100 mm

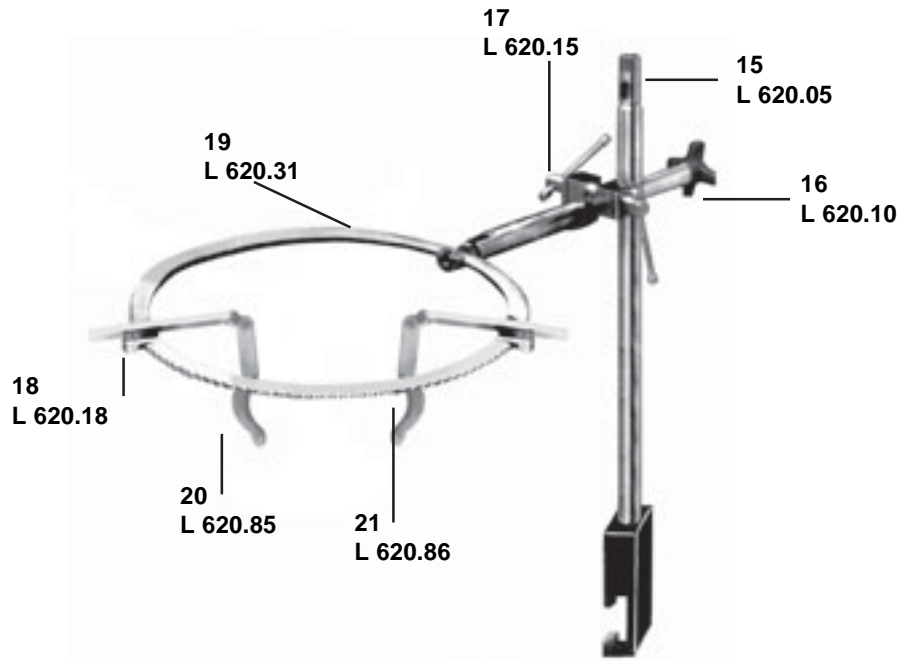
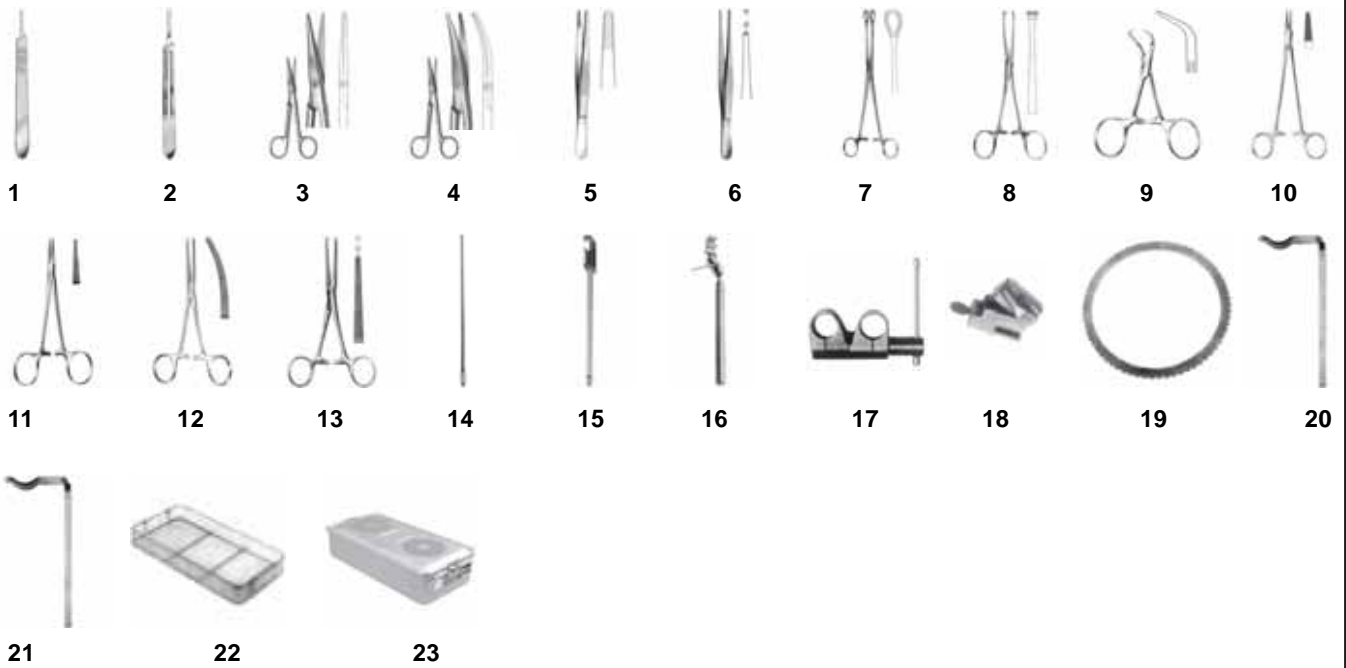

Bookwalter Rectal Kit

No	Quantity	Code	Description
1	1	B 030.01	Scalpel Handle 3 no, 13.5 cm
2	1	B 040.01	Scalpel Handle 4 no, 13.5 cm
3	1	C 442.01	Mayo Stille Surgical Scissors, Straight, 17 cm
4	1	C 443.01	Mayo Stille Surgical Scissors, Curved, 17 cm
5	2	D 240.02	Standart Dissecting Forcep, 14.5 cm
6	2	D 360.03	Standart Tissue Forcep, 14.5 cm
7	2	E 086.00	Foerster-Ballenger Organ and Tissue Forcep, Straight, 24 cm
8	6	E 144.00	Allis Tissue Grasping Forcep, 5x6 teeth, 15.5 cm
9	6	E 430.02	Backhaus Towel Clamp, 13.5 cm
10	2	F 355.01	Hegar-Mayo Needle Holder, 18 cm
11	6	G 206.00	Micro-Halsted Delicate Haemostatic Forcep, Straight, 12.5 cm
12	6	G 431.00	Rochester-Pean Haemostatic Forcep, Curved, 16 cm
13	4	G 444.00	Kocher Haemostatic Forcep, Straight, 15 cm
14	1	J 035.00	Probe, Ø 2.5 mm 14.5 cm
15	1	L 620.05	Bookwalter Abdominal Table Post, 43 cm
16	1	L 620.10	Bookwalter Abdominal 360° flex bar
17	1	L 620.15	Bookwalter Abdominal Horizontal Bar
18	4	L 620.18	Bookwalter Abdominal Ratchet Mechanisms
19	1	L 620.31	Bookwalter Abdominal Retractor Ø 215 mm
20	1	L 620.85	Bookwalter Abdominal Retractor 75 mm
21	1	L 620.86	Bookwalter Abdominal Retractor 100 mm
22	1	Y 191.07	Wire Basket, 540x255x70 mm
23	1	Y 110.13	1/1 Size Container, 580x280x135 mm



1



2



3



4



5



6



7



8



9



10



11



12



13

No	Quantity	Code	Description
1	1	B 030.01	Scalpel Handle 3 no, 13.5 cm
2	1	C 311.03	Surgical Scissors, Curved, 14.5 cm
3	1	D 240.01	Standart Dissecting Forcep, 14.5 cm
4	1	D 360.03	Standart Tissue Forcep, 14.5 cm
5	1	E 086.00	Foerster-Ballenger Organ and Tissue Forcep, Straight, 24 cm
6	6	E 144.00	Allis Tissue Grasping Forcep, 5x6 teeth, 15.5 cm
7	4	F 230.01	Mayo-Hegar Needle Holder, 18 cm
8	2	G 431.00	Rochester-Pean Haemostatic Forcep, Curved, 16 cm
9	2	K 138.00	Gillies Skin Hook, 18 cm
10	2	K 432.01	Volkman Retractor, Sharp, 9x13 mm, 22 cm
11	1	L 708.00	Sims Rectal Specula, 17x77 mm, 16 cm
12	1	Y 390.07	Wire Basket, 255x245x70 mm
13	1	Y 310.10	1/1 Size Container, 285x280x100 mm

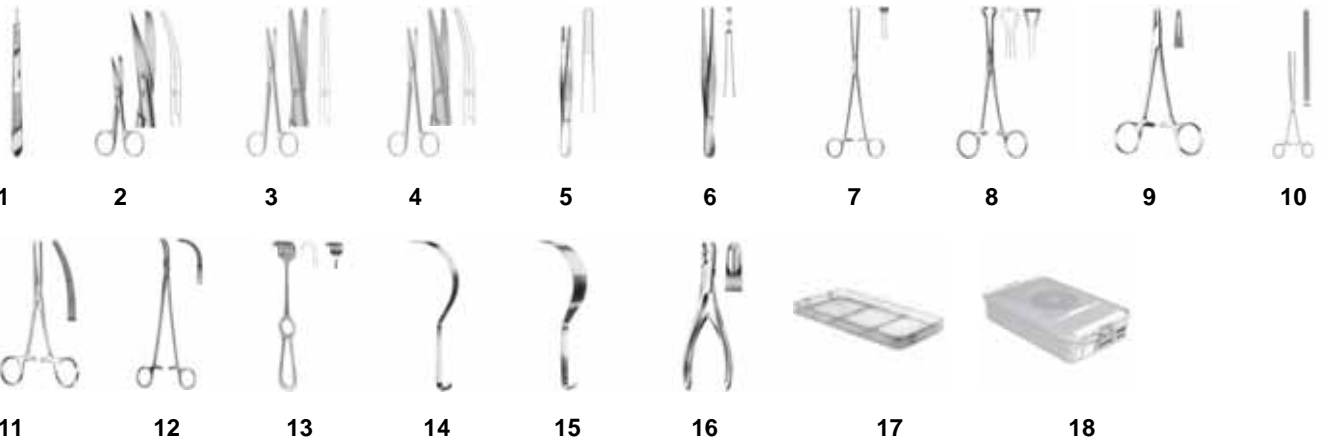

No	Quantity	Code	Description
1	1	B 030.02	Scalpel Handle 3 no, 21.5 cm
2	1	C 311.03	Surgical Scissors, Curved, 14.5 cm
3	1	C 458.01	Mayo Surgical Scissors, Straight, 20 cm
4	1	C 459.01	Mayo Surgical Scissors, Curved, 20 cm
5	1	D 240.05	Standart Dissecting Forcep, 20 cm
6	1	D 360.06	Standart Tissue Forcep, 20 cm
7	6	E 147.01	Allis Tissue Grasping Forcep, 5x6 teeth, 19 cm
8	4	E 174.01	Babcock Organ and Tissue Grasping Forcep, 21.5 cm
9	1	F 230.01	Mayo-Hegar Needle Holder, 18 cm
10	4	G 368.02	Doyen Intestinal Clamp, Elastic, Straight, 23.5 cm
11	6	G 431.02	Rochester-Pean Haemostatic Forcep, Curved, 20 cm
12	6	G 654.00	Mixter Ligature Forcep, Curved, 23 cm
13	2	K 433.02	Vollkman Retractor, Blunt, 8x19 mm. 22 cm
14	2	K 660.04	Deaver Retractor, 75 mm, 30 cm
15	2	K 660.07	Deaver Retractor, 50 mm, 31 cm
16	1	P 290.00	Luer Bone Rongeur, 17.5 cm
17	1	Y 290.07	Wire Basket, 405x255x70 mm
18	1	Y 210.10	1/2 Size Container, 465x280x100 mm



1



2



3



4



5



6



7



8



9



10



11



12



13



14



15



16



17



18



19



20



21



22



23



24



25



26



27



28



29



30



31



32



33



34



35



36



37



38



39



40



41



42



43



44



45



46



47



48



49



50



51



52



53



54



55

No	Quantity	Code	Description
1	2	A 202.00	Pinard Stethoscope 15.5 cm
2	1	B 030.01	Scalpel Handle 3 No 13.5 cm
3	1	B 040.01	Scalpel Handle 4 No 13.5 cm
4	1	C 440.01	Mayo Surgical Scissors 15.5 cm
5	1	C 440.02	Mayo Surgical Scissors 17 cm
6	2	D 240.03	Dissecting Forcep 16 cm
7	2	D 360.04	Tissue Forcep 16 cm
8	2	E 270.01	Collin-Pozzi Uterine Tenaculum Forcep 25 cm
9	1	E 380.02	Museux Uterine Tenaculum Forcep 24 cm
10	1	E 700.01	Winter Placenta And Ovum Forcep 29 cm
11	1	E 700.02	Winter Placenta And Ovum Forcep 29 cm
12	1	E 700.03	Winter Placenta And Ovum Forcep 29 cm
13	1	E 702.01	Winter Placenta And Ovum Forcep 29 cm
14	1	E 702.02	Winter Placenta And Ovum Forcep 29 cm
15	1	E 702.03	Winter Placenta And Ovum Forcep 29 cm
16	1	F 230.00	Mayo-hegar Needle Holder 15 cm
17	1	F 230.01	Mayo-hegar Needle Holder 18 cm
18	4	G 423.00	Pean Haemostatic Forcep 13 cm
19	4	G 448.00	Kocher- Ochsner Haemostatic Forcep 16 cm
20	1	J 033.16	Probe Ø 2 mm 16 cm
21	1	J 652.08	Sims Uterine Probe Malleable 33 cm
22	1	J 750.02	Hegar Uterine Dilator 2 mm 18.5 cm
23	1	J 750.03	Hegar Uterine Dilator 3 mm 18.5 cm
24	1	J 750.04	Hegar Uterine Dilator 4 mm 18.5 cm
25	1	J 750.05	Hegar Uterine Dilator 5 mm 18.5 cm
26	1	J 750.06	Hegar Uterine Dilator 6 mm 18.5 cm
27	1	J 750.07	Hegar Uterine Dilator 7 mm 18.5 cm
28	1	J 750.08	Hegar Uterine Dilator 8 mm 18.5 cm
29	1	J 750.09	Hegar Uterine Dilator 9 mm 18.5 cm
30	1	J 750.10	Hegar Uterine Dilator 10 mm 18.5 cm
31	1	J 750.11	Hegar Uterine Dilator 11 mm 18.5 cm
32	1	J 750.12	Hegar Uterine Dilator 12 mm 18.5 cm
33	1	J 751.01	Hegar Uterine Dilator 1.5 mm 18.5 cm
34	1	J 751.02	Hegar Uterine Dilator 2.5 mm 18.5 cm
35	1	J 751.03	Hegar Uterine Dilator 3.5 mm 18.5 cm
36	1	J 751.04	Hegar Uterine Dilator 4.5 mm 18.5 cm
37	1	J 751.05	Hegar Uterine Dilator 5.5 mm 18.5 cm
38	1	J 751.06	Hegar Uterine Dilator 6.5 mm 18.5 cm
39	1	J 751.07	Hegar Uterine Dilator 7.5 mm 18.5 cm
40	1	J 751.08	Hegar Uterine Dilator 8.5 mm 18.5 cm
41	1	J 751.09	Hegar Uterine Dilator 9.5 mm 18.5 cm
42	1	J 751.10	Hegar Uterine Dilator 10.5 mm 18.5 cm
43	1	J 751.11	Hegar Uterine Dilator 11.5 mm 18.5 cm
44	1	J 751.12	Hegar Uterine Dilator 12.5 mm 18.5 cm
45	3	L 763.02	Cusco Vaginal Specula 100 X 25-27 mm
46	2	L 770.01	Cusco Vaginal Specula 75 X 17 mm
47	3	L 771.02	Cusco Vaginal Specula 80 X 32 mm
48	1	N 520.08	Recamier Uterine Scoop Sharp-rigid 7.5 Mm 30 cm
49	1	N 520.09	Recamier Uterine Scoop Sharp-rigid 8.5 Mm 30 cm
50	1	N 520.12	Recamier Uterine Scoop Sharp-rigid 10.5 Mm 30 cm
51	1	N 520.15	Recamier Uterine Scoop Sharp-rigid 12 Mm 30 cm
52	1	N 520.19	Recamier Uterine Scoop Sharp-rigid 14 Mm 30 cm
53	1	Y 210.13	3/4 Size Container 465 X 280 X 135 mm Botton Non Perforated
54	1	Y 290.03	3/4 Wire Basket 405 X 255 X 30 mm
55	1	Y 290.05	3/4 Wire Basket 405 X 255 X 50 mm



1 2 3 4 5 6 7 8 9 10

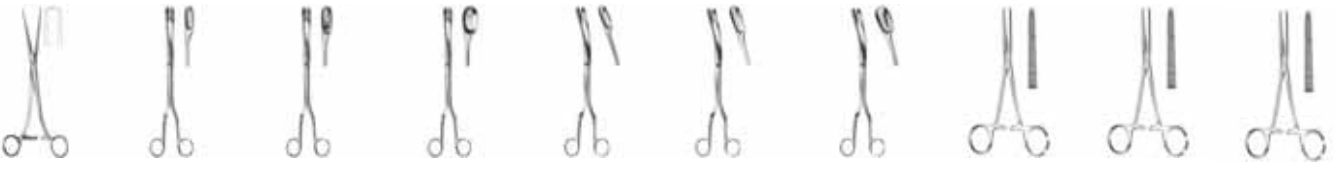

11 12 13 14 15 16 17 18 19 20



21 22 23 24 25 26 27 28 29 30



31 32 33 34 35 36 37 38 39 40



41 42 43 44 45 46 47 48 49 50



51 52 53 54 55 56 57 58



59 60 61

No	Quantity	Code	Description
1	1	A 201.00	Stethoscope Wooden 14.5 cm
2	1	B 030.01	Scalpel Handle 3 No 13.5 cm
3	1	B 040.01	Scalpel Handle 4 No 13.5 cm
4	2	C 440.01	Mayo Surgical Scissors 15.5 cm
5	1	C 456.00	Mayo-harrington Surgical Scissors Straight 23 cm
6	1	C 457.00	Mayo-harrington Surgical Scissors Curved 23 cm
7	2	D 240.03	Dissecting Forceps 16 cm
8	1	D 360.04	Tyssue Forceps 16 cm
9	2	E 058.00	Sims-maier Sponge And Dressing Forcep 28 cm
10	5	E 255.01	Pozzi Uterine Tenaculum Forcep 25.5 cm
11	2	E 270.01	Collin-pozzi Uterine Tenaculum Forceps 25 cm
12	1	E 700.01	Winter Placenta And Ovum Forcep 29 cm
13	1	E 700.02	Winter Placenta And Ovum Forcep 29 cm
14	1	E 700.03	Winter Placenta And Ovum Forcep 29 cm
15	1	E 702.01	Winter Placenta And Ovum Forcep 29 cm
16	1	E 702.02	Winter Placenta And Ovum Forcep 29 cm
17	1	E 702.03	Winter Placenta And Ovum Forcep 29 cm
18	1	G 430.00	Rochester-pean Haemostatic Forcep Straight 16 cm
19	1	G 430.01	Rochester-pean Haemostatic Forcep Straight 18.5 cm
20	1	G 430.02	Rochester-pean Haemostatic Forcep Straight 20 cm
21	1	G 431.00	Rochester-pean Haemostatic Forcep Curved 16 cm
22	1	G 431.01	Rochester-pean Haemostatic Forcep Curved 18.5 cm
23	1	G 431.02	Rochester-pean Haemostatic Forcep Curved 20 cm
24	1	G 448.00	Kocher-ochsner Haemostatic Forcep Straight 16 cm
25	1	G 448.01	Kocher-ochsner Haemostatic Forcep Straight 18.5 cm
26	1	G 448.02	Kocher-ochsner Haemostatic Forcep Straight 20 cm
27	1	G 449.00	Kocher-ochsner Haemostatic Forcep Curved 16 cm
28	1	G 449.01	Kocher-ochsner Haemostatic Forcep Curved 18.5 cm
29	1	G 449.02	Kocher-ochsner Haemostatic Forcep Curved 20 cm
30	1	J 033.16	Probe Ø 2 mm 16 cm
31	2	J 490.00	Schulze Vacuum Curette Complete(J 490.01, J 490.02, J 490.03, J 490.04)
32	2	J 652.08	Sims Uterine Probe Malleable 33 cm
33	1	J 750.01	Hegar Uterine Dilator 1 mm 18.5 cm
34	1	J 750.02	Hegar Uterine Dilator 2 mm 18.5 cm
35	1	J 750.03	Hegar Uterine Dilator 3 mm 18.5 cm
36	1	J 750.04	Hegar Uterine Dilator 4 mm 18.5 cm
37	1	J 750.05	Hegar Uterine Dilator 5 mm 18.5 cm
38	1	J 750.06	Hegar Uterine Dilator 6 mm 18.5 cm
39	1	J 750.07	Hegar Uterine Dilator 7 mm 18.5 cm
40	1	J 750.08	Hegar Uterine Dilator 8 mm 18.5 cm
41	1	J 750.09	Hegar Uterine Dilator 9 mm 18.5 cm
42	1	J 750.10	Hegar Uterine Dilator 10 mm 18.5 cm
43	1	J 750.11	Hegar Uterine Dilator 11 mm 18.5 cm
44	1	J 750.12	Hegar Uterine Dilator 12 mm 18.5 cm
45	1	J 750.13	Hegar Uterine Dilator 13 mm 18.5 cm
46	1	J 751.01	Hegar Uterine Dilator 1.5 mm 18.5 cm
47	1	J 751.02	Hegar Uterine Dilator 2.5 mm 18.5 cm
48	1	J 751.03	Hegar Uterine Dilator 3.5 mm 18.5 cm
49	1	J 751.04	Hegar Uterine Dilator 4.5 mm 18.5 cm
50	1	J 751.05	Hegar Uterine Dilator 5.5 mm 18.5 cm
51	1	J 751.06	Hegar Uterine Dilator 6.5 mm 18.5 cm
52	1	J 751.07	Hegar Uterine Dilator 7.5 mm 18.5 cm
53	1	J 751.08	Hegar Uterine Dilator 8.5 mm 18.5 cm
54	1	J 751.09	Hegar Uterine Dilator 9.5 mm 18.5 cm
55	1	J 751.10	Hegar Uterine Dilator 10.5 mm 18.5 cm
56	1	J 751.11	Hegar Uterine Dilator 11.5 mm 18.5 cm
57	1	J 751.12	Hegar Uterine Dilator 12.5 mm 18.5 cm
58	1	J 751.13	Hegar Uterine Dilator 13.5 mm 18.5 cm
59	1	Y 390.03	Wire Basket, 255x245x30 mm
60	1	Y 290.05	Wire Basket, 405x255x50 mm
61	1	Y 210.10	3/4 Size Container, 465x280x100 mm

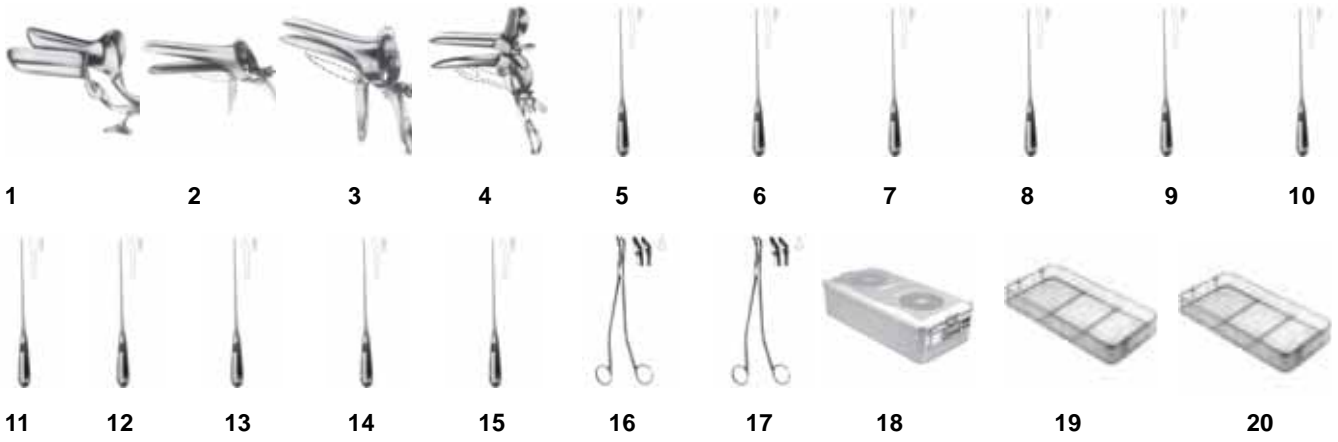

No	Quantity	Code	Description
1	2	L 754.02	Collin Vaginal Spekula 100/90 mm 32 mm
2	2	L 763.03	Cusco Vaginal Spekula 110 X 27-30 mm
3	5	L 765.02	Cusco Vaginal Spekula 90 X 37 mm
4	3	L 785.02	Trelat Vaginal Spekula 95 X 35 mm
5	1	N 520.08	Recamier Uterine Scoop Sharp-rigid 7.5 mm 30 cm
6	1	N 520.09	Recamier Uterine Scoop Sharp-rigid 8.5 mm 30 cm
7	1	N 520.12	Recamier Uterine Scoop Sharp-rigid 10.5 mm 30 cm
8	1	N 520.15	Recamier Uterine Scoop Sharp-rigid 12 mm 30 cm
9	1	N 520.19	Recamier Uterine Scoop Sharp-rigid 14 mm 30 cm
10	1	N 520.21	Recamier Uterine Scoop Sharp-rigid 15 mm 30 cm
11	1	N 520.24	Recamier Uterine Scoop Sharp-rigid 16.5 mm 30 cm
12	1	N 520.27	Recamier Uterine Scoop Sharp-rigid 18 mm 30 cm
13	1	N 520.30	Recamier Uterine Scoop Sharp-rigid 19.5 mm 30 cm
14	1	N 520.34	Recamier Uterine Scoop Sharp-rigid 21.5 mm 30 cm
15	1	N 520.38	Recamier Uterine Scoop Sharp-rigid 23.5 mm 30 cm
16	1	R 715.01	Schumacher Biopsy Forcep 24 cm
17	1	R 715.02	Schumacher Biopsy Forcep 24 cm
18	1	Y 110.15	1/1 Size Container Basic Model 580 X 280 X 150 mm
19	1	Y 190.03	1/1 Wire Basket 540 X 255 X 30 mm
20	1	Y 190.07	1/1 Wire Basket 540 X 255 X 70 mm

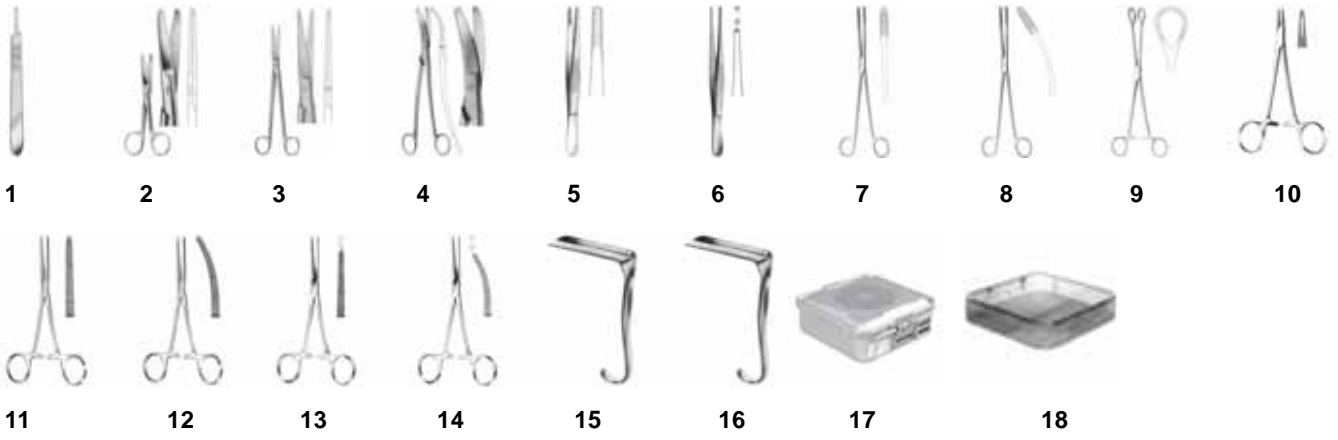

No	Quantity	Code	Description
1	1	B 030.01	Scalpel Handle 3 no, 13.5 cm
2	1	C 312.04	Surgical Scissors Straight 15 cm
3	1	C 456.00	Mayo-harringtonn Surgical Scissors Straight 23 cm
4	1	C 491.00	Siebold Deep Operation Scissors 24.5 cm
5	2	D 240.03	Dissecting Forcep 16 cm
6	2	D 360.04	Tissue Forcep 16 cm
7	1	E 050.00	Maier Dressing Forceps Straight 26.5 cm
8	1	E 051.00	Maier Dressing Forceps Curved 26.5 cm
9	2	E 130.01	Plypus And Ovum Forceps
10	2	F 230.01	Mayo-hegar Needle Holder 18 cm
11	2	G 430.01	Rochester-pean Haemostatic Forcep Straight 18.5 cm
12	2	G 431.01	Rochester-pean Haemostatic Forcep Curved 18.5 cm
13	1	G 448.01	Rochester-pean Haemostatic Forcep Straight 18.5 cm
14	1	G 449.01	Rochester-pean Haemostatic Forcep Curved 18.5 cm
15	1	K 819.03	Jackson Vaginal Specula 17.5 cm 89 X 38 mm
16	1	K 819.04	Jackson Vaginal Specula 17.5 cm 102 X 38 mm
17	1	Y 310.10	1/2 Size Container Bottom Non Perforated 285 X 280 X 100 mm
18	1	Y 390.05	1/2 Wire Basket 255 X 245 X 50 mm



1



2



3



4



5



6



7



8



9



11



12

No	Quantity	Code	Description
1	1	C 612.02	Dubois Scissors For Obstetric Straight 27.5 cm
2	1	C 613.02	Dubois Scissors For Obstetric Curved 27.5 cm
3	1	E 557.02	Nagele Obstetrical Forcep 35.5 cm
4	1	E 565.02	Kielland Obstetrical Forcep 42 cm
5	1	E 567.02	Piper Obstetrical Forcep 44.5 cm
6	1	E 598.02	Gauss Obstetrical Forcep 26 cm
7	1	T 430.01	Simelle Placenda And Ovum Forcep 27 cm
8	1	T 436.01	Tarnieer Placenda And Ovum Forcep 44 cm
9	1	T 440.02	Braun Placenda And Ovum Forcep 42 cm
10	1	Y 210.10	3/4 Size Container 465 X 280 X 100 mm Botton Non Perforated
11	1	Y 290.05	3/4 Wire Basket 405 X 255 X 50 mm

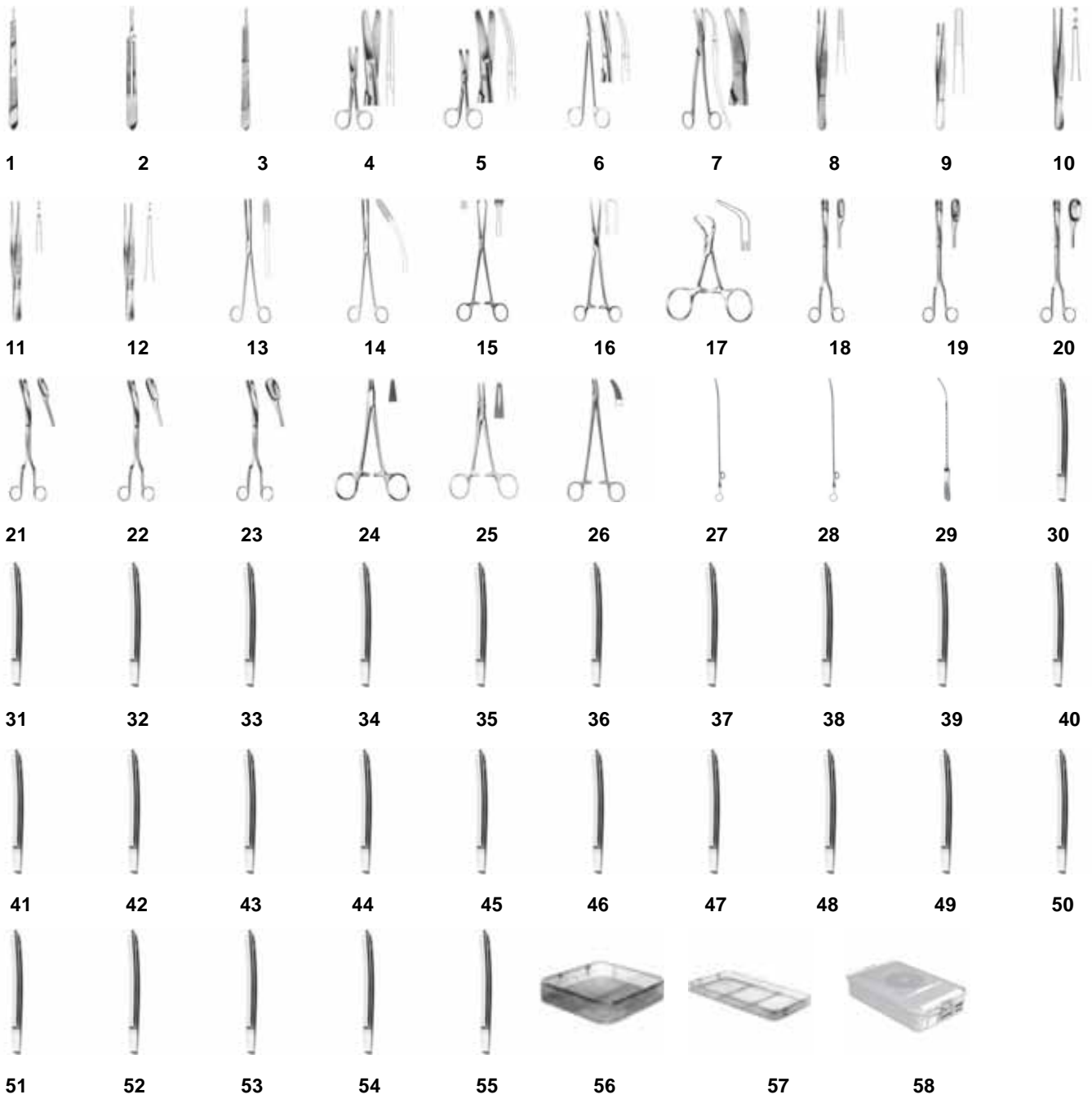

No	Quantity	Code	Description
1	2	B 030.02	Scalpel Handle 3 No 21.5 cm
2	2	B 040.01	Scalpel Handle 4 No 13.5 cm
3	2	B 040.02	Scalpel Handle 3 No 21.5 cm
4	2	C 312.03	Surgical Scissors Straight/Blunt 14.5 cm
5	3	C 313.03	Cooper Surgical Scissors Curved/Blunt 14.5 cm
6	2	C 416.00	Toennis-adson Dissecting Scissors 17.5 cm
7	1	C 491.00	Siebold Deep Operation Scissors 24.5 cm
8	2	D 225.02	Dissecting Forcep Straight 14.5 cm
9	1	D 240.05	Dissecting Forcep Straight 20 cm
10	2	D 360.03	Tissue Forcep Straight 14.5 cm
11	2	D 361.01	Tissue Forcep Delicate 13 cm
12	2	D 361.03	Tissue Forcep Delicate 16 cm
13	1	E 050.00	Maier Sponge And Dressing Forcep Straight 26.5 cm
14	1	E 051.00	Maier Sponge And Dressing Forcep Curved 26.5 cm
15	2	E 150.00	Allis Dressing-organ And Tissue Forcep 15.5 cm
16	2	E 255.01	Pozzi Uterine Tenaculum Forcep 25.5 cm
17	8	E 430.01	Backhaus Towel Clamp 11 cm
18	2	E 700.01	Winter Placenta And Ovum Forcep 29 cm
19	2	E 700.02	Winter Placenta And Ovum Forcep 29 cm
20	2	E 700.03	Winter Placenta And Ovum Forcep 29 cm
21	2	E 702.01	Winter Placenta And Ovum Forcep 29 cm
22	2	E 702.02	Winter Placenta And Ovum Forcep 29 cm
23	2	E 702.03	Winter Placenta And Ovum Forcep 29 cm
24	2	F 210.00	Baumgartner Needle Holder 14.5 cm
25	1	F 231.01	Hegar Needle Holder 15 cm
26	2	F 373.00	Heaney Needle Holder 20 cm
27	1	J 095.12	Endospecula Charr 12 16 cm
28	1	J 095.16	Endospecula Charr 16 16 cm
29	1	J 653.05	Uterine Probe 30 cm
30	1	J 750.01	Hegar Uterine Dilator 1 mm 18.5 cm
31	1	J 750.02	Hegar Uterine Dilator 2 mm 18.5 cm
32	1	J 750.03	Hegar Uterine Dilator 3 mm 18.5 cm
33	1	J 750.04	Hegar Uterine Dilator 4 mm 18.5 cm
34	1	J 750.05	Hegar Uterine Dilator 5 mm 18.5 cm
35	1	J 750.06	Hegar Uterine Dilator 6 mm 18.5 cm
36	1	J 750.07	Hegar Uterine Dilator 7 mm 18.5 cm
37	1	J 750.08	Hegar Uterine Dilator 8 mm 18.5 cm
38	1	J 750.09	Hegar Uterine Dilator 9 mm 18.5 cm
39	1	J 750.10	Hegar Uterine Dilator 10 mm 18.5 cm
40	1	J 750.11	Hegar Uterine Dilator 11 mm 18.5 cm
41	1	J 750.12	Hegar Uterine Dilator 12 mm 18.5 cm
42	1	J 750.13	Hegar Uterine Dilator 13 mm 18.5 cm
43	1	J 751.01	Hegar Uterine Dilator 1.5 mm 18.5 cm
44	1	J 751.02	Hegar Uterine Dilator 2.5 mm 18.5 cm
45	1	J 751.03	Hegar Uterine Dilator 3.5 mm 18.5 cm
46	1	J 751.04	Hegar Uterine Dilator 4.5 mm 18.5 cm
47	1	J 751.05	Hegar Uterine Dilator 5.5 mm 18.5 cm
48	1	J 751.06	Hegar Uterine Dilator 6.5 mm 18.5 cm
49	1	J 751.07	Hegar Uterine Dilator 7.5 mm 18.5 cm
50	1	J 751.08	Hegar Uterine Dilator 8.5 mm 18.5 cm
51	1	J 751.09	Hegar Uterine Dilator 9.5 mm 18.5 cm
52	1	J 751.10	Hegar Uterine Dilator 10.5 mm 18.5 cm
53	1	J 751.11	Hegar Uterine Dilator 11.5 mm 18.5 cm
54	1	J 751.12	Hegar Uterine Dilator 12.5 mm 18.5 cm
55	1	J 751.13	Hegar Uterine Dilator 13.5 mm 18.5 cm
56	1	Y 390.03	Wire Basket, 255x245x30 mm
57	1	Y 290.05	Wire Basket, 405x255x50 mm
58	1	Y 210.10	3/4 Size Container, 465x280x100 mm



1



2



3



4



5



6



7



8



9



10



11



12



13

No	Quantity	Code	Description
1	2	K 610.01	Tubinger Vaginal Retractor 95x20 mm 26.5 cm
2	1	K 863.01	Auvar Vaginal Retractor 75x42 mm 23 cm
3	1	L 785.02	Trelat Vaginal Specula 95x35 mm
4	1	N 520.08	Recamier Uterine Scoop Sharp-rigid 7.5 mm 30 cm
5	1	N 520.09	Recamier Uterine Scoop Sharp-rigid 8.5 mm 30 cm
6	1	N 520.12	Recamier Uterine Scoop Sharp-rigid 10.5 mm 30 cm
7	1	N 520.15	Recamier Uterine Scoop Sharp-rigid 12 mm 30 cm
8	1	N 520.19	Recamier Uterine Scoop Sharp-rigid 14 mm 30 cm
9	1	N 520.21	Recamier Uterine Scoop Sharp-rigid 15 mm 30 cm
10	1	N 520.24	Recamier Uterine Scoop Sharp-rigid 16.5 mm 30 cm
11	1	N 520.27	Recamier Uterine Scoop Sharp-rigid 18 mm 30 cm
12	1	Y 290.07	Wire Basket, 405x255x70 mm
13	1	Y 210.10	1/2 Size Container, 465x280x100 mm

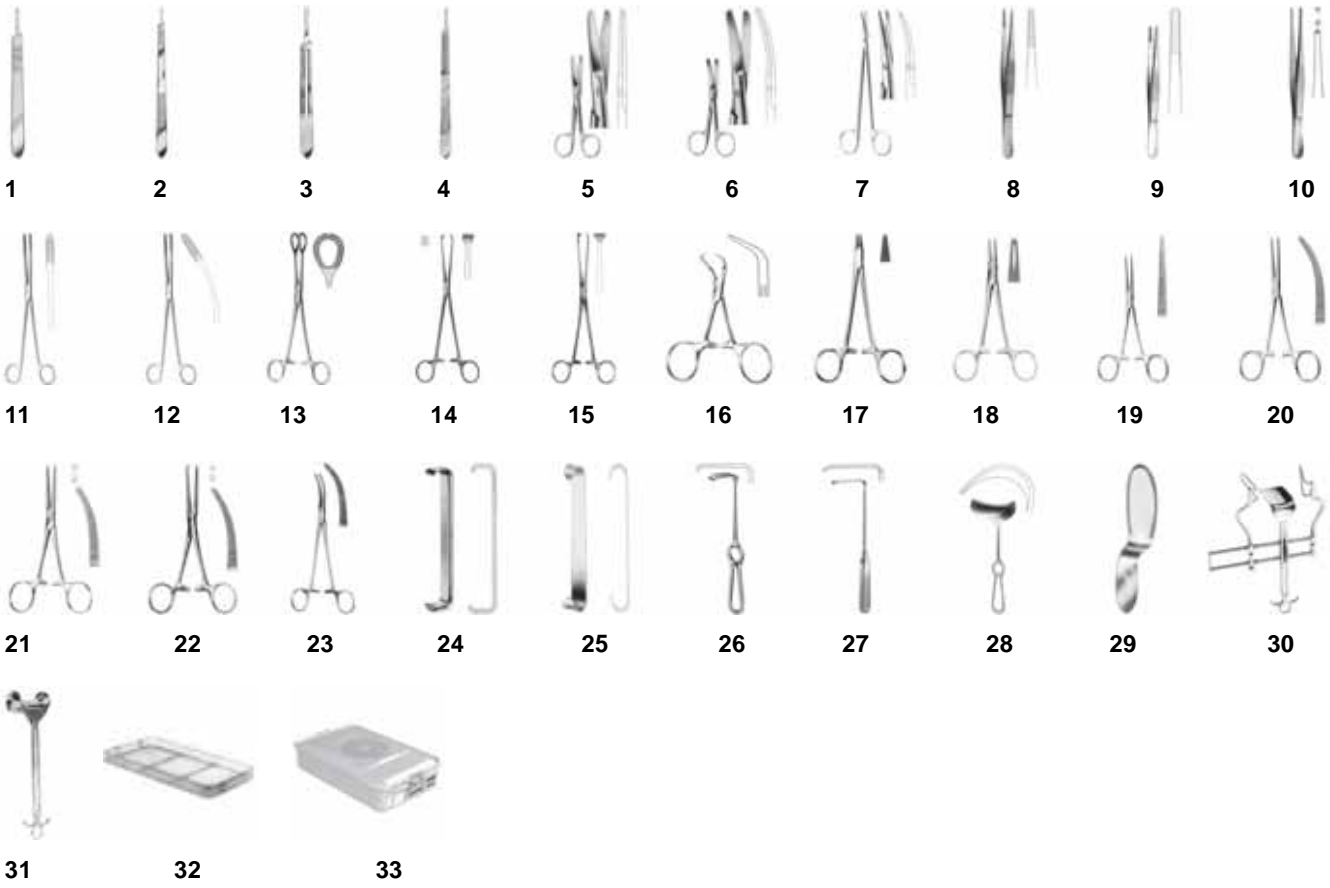

No	Quantity	Code	Description
1	2	B 030.01	Scalpel Handle 3 No, 13.5 cm
2	2	B 030.02	Scalpel Handle 3 No, 21.5 cm
3	2	B 040.01	Scalpel Handle 3 No, 13.5 cm
4	2	B 040.02	Scalpel Handle 3 No, 21.5 cm
5	2	C 312.03	Surgical Scissors Straight 14.5 cm
6	2	C 313.03	Surgical Scissors Curved 14.5 cm
7	1	C 416.00	Toennis-adson Dissecting Scissors 17.5 cm
8	2	D 225.02	Dissecting Forcep 14.5 cm
9	2	D 240.05	Dissecting Forcep 20 cm
10	2	D 360.03	Tissue Forcep 14.5 cm
11	1	E 050.00	Maier Dressing Forcep Straight 26.5 cm
12	1	E 051.00	Maier Dressing Forcep Curved 26.5 cm
13	4	E 089.00	Heywood-smith Forcep 21.5 Cm
14	2	E 150.00	Allis Diressing Forcep 15.5 cm
15	2	E 159.00	Allis Forcep 22 cm
16	8	E 430.01	Backhaus Towel Clamps 11 cm
17	2	F 210.00	Baumgartner Needle Holder 14.5 cm
18	2	F 231.01	Hegar Needle Holder Curved 14.5 cm
19	5	G 420.00	Pean Haemostatic Forcep Straight 13 cm
20	5	G 421.00	Pean Haemostatic Forcep Curved 13 cm
21	2	G 439.00	Rochester-ochsnen Haemostatic Forcep 14 cm
22	2	G 445.00	Kocher Haemostatic Forcep Curved 14 cm
23	2	G 722.00	Heaney Hysterectomy Forcep Curved 20.5 cm
24	1	K 311.00	Farabeuf Retractor 15 cm
25	2	K 315.00	Baby-roux Retractor 13.5 cm
26	1	K 460.04	Kocher Retractor 23 cm
27	1	K 461.02	Sauerbruch Retractor 22.5 cm
28	1	K 715.04	Fritsh Abdominal Retractor 24 cm
29	1	K 764.00	Reverdin Spatulas 28.5 cm
30	2	L 532.01	Balfour Abdominal Retractor (With L 580.23)
31	2	L 580.30	Balfour Abdominal Retractor Center Blade 540 X 80 mm
32	1	Y 290.05	Wire Basket, 405x255x50 mm
33	1	Y 210.10	1/2 Size Container, 465x280x100 mm

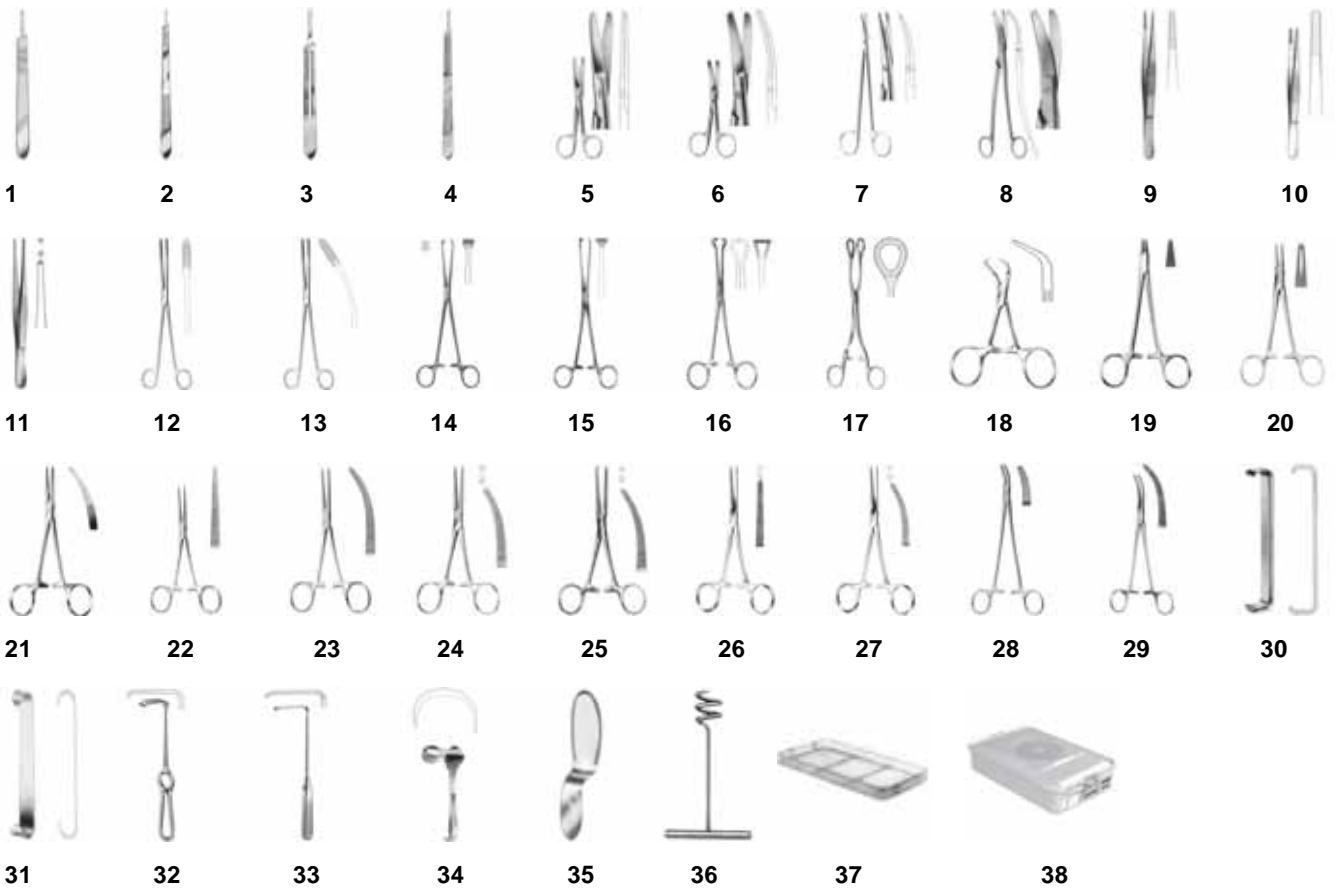

No	Quantity	Code	Description
1	2	B 030.01	Scalpel Handle 3 No, 13.5 cm
2	2	B 030.02	Scalpel Handle 3 No, 21.5 cm
3	2	B 040.01	Scalpel Handle 3 No, 13.5 cm
4	2	B 040.02	Scalpel Handle 3 No, 21.5 cm
5	2	C 312.03	Surgical Scissors Straight 14.5 cm
6	2	C 313.03	Surgical Scissors Curved 14.5 cm
7	2	C 416.00	Toennis-adson Dissecting Scissors 17.5 cm
8	1	C 491.00	Siebold Deep Operation Scissors 24.5 cm
9	2	D 225.02	Dissecting Forcep 14.5 cm
10	4	D 240.05	Dissecting Forcep 20 cm
11	2	D 360.03	Tissue Forcep 14.5 cm
12	1	E 050.00	Maier Dressing Forcep Straight 26.5 cm
13	1	E 051.00	Maier Dressing Forcep Curved 26.5 cm
14	2	E 150.00	Allis Diressing Forcep 15.5 cm
15	2	E 159.00	Allis Forcep 22 cm
16	1	E 174.01	Babcock Organ And Tissue Grasping Forceps 21.5 cm
17	2	E 190.00	Heywood-smith Dressing Forcep 20 cm
18	8	E 430.01	Backhaus Towel Clamp 11 cm
19	2	F 210.00	Baumgartner Needle Holder 14.5 cm
20	2	F 231.01	Hegar Needle Holder Curved 14.5 cm
21	2	G 235.00	Kelly Delicate Haemostatic Forcep Curved 14 cm
22	6	G 420.00	Pean Haemostatic Forcep Straight 13 cm
23	6	G 421.00	Pean Haemostatic Forcep Curved 13 cm
24	4	G 439.00	Rochester-ochsner Haemostatic Forcep 14 cm
25	4	G 445.00	Kocher Haemostatic Forcep Curved 14 cm
26	2	G 448.02	Kocher-ochsner Haemostatic Forcep Straight 20 cm
27	2	G 449.02	Kocher-ochsner Haemostatic Forcep Curved 20 cm
28	2	G 701.00	Faure Peritoneum Forcep Curved 20.5 cm
29	4	G 722.00	Heaney Hysterectomy Forcep Curved 20.5 cm
30	1	K 311.00	Farabeuf Retractor 15 cm
31	2	K 315.00	Baby-roux Retractor 13.5 cm
32	1	K 460.04	Kocher Retractor 23 cm
33	1	K 461.02	Sauerbruch Retractor 22.5 cm
34	1	K 710.00	Doyen Abdominal Retractor 26 cm
35	1	K 764.00	Reverdin Spatulas 28.5 cm
36	1	T 420.00	Doyen Myoma Instrument 15 cm
37	1	Y 290.05	Wire Basket, 405x255x50 mm
38	1	Y 210.10	1/2 Size Container, 465x280x100 mm

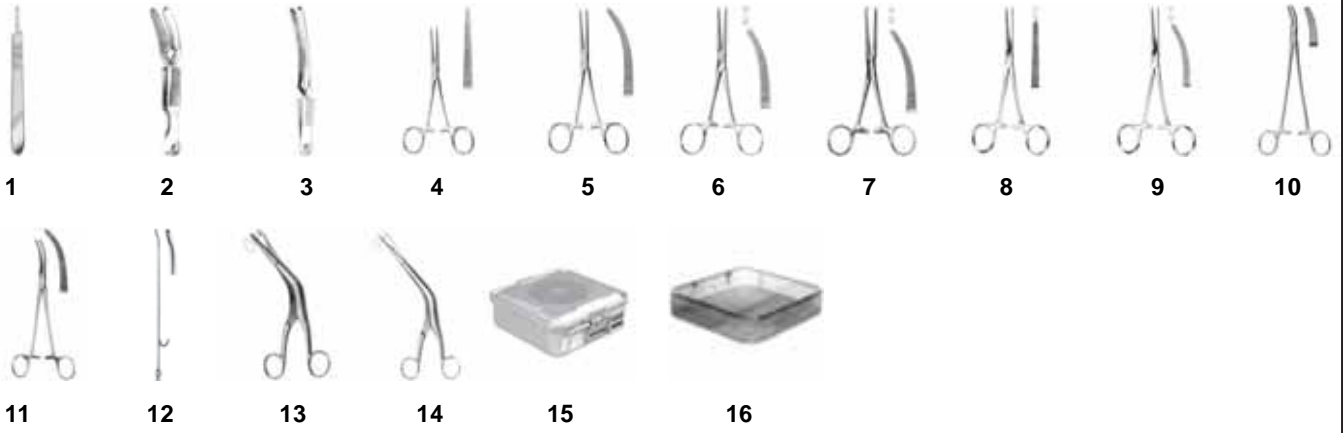

No	Quantity	Code	Description
1	2	B 030.01	Scalpel Handle 3 No 13.5 cm
2	4	G 023.00	Dieffenbach Bulldog Clamp 6 cm
3	4	G 024.04	Johns-hopkins Bulldog Clamp 6 cm
4	6	G 420.00	Pean Haemostatic Forcep Straight 13 cm
5	6	G 421.00	Pean Haemostatic Forcep Curved 13 cm
6	6	G 439.00	Rochester-ochsner Haemostatic Forcep Curved 14 cm
7	6	G 445.00	Kocher Haemostatic Forcep Curved 15 cm
8	4	G 448.02	Rochester-Ochsner Haemostatic Forcep Straight 20 cm
9	4	G 449.02	Rochester-Ochsner Haemostatic Forcep Curved 20 cm
10	2	G 701.00	Faure Peritoneum Forcep Curved 20.5 cm
11	4	G 722.00	Heaney Hysterectomy Forcep Curved 20.5 cm
12	2	N 581.02	Novak-schoeckaert Biopsy Curette 24 cm
13	1	R 710.01	Faure Biopsy Forcep 21 cm
14	2	R 710.03	Faure Biopsy Forcep 24 cm
15	1	Y 310.10	1/2 Size Container 285 X 280 X 100 mm
16	1	Y 390.05	1/2 Wire Basket 255 X 245 X 50 mm

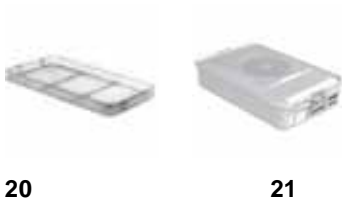
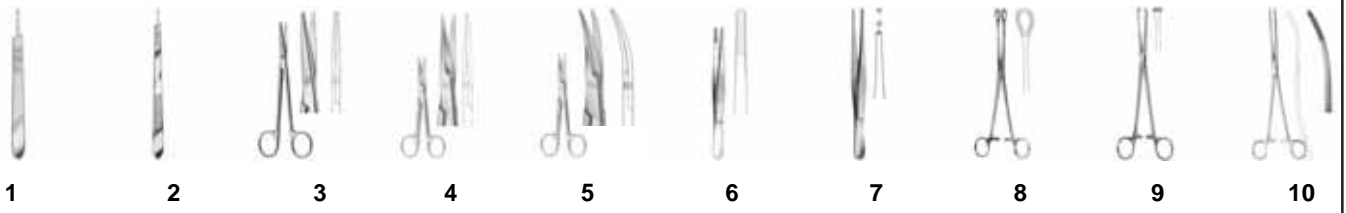

No	Quantity	Code	Description
1	1	B 030.01	Scalpel Handle 3 No 13.5 cm
2	1	B 030.02	Scalpel Handle 3 No 21.5 cm
3	1	C 420.01	Metzenbaum Dissecting Scissors 18 cm
4	1	C 440.02	Mayo Surgical Scissors Straight 17 cm
5	1	C 441.02	Mayo Surgical Scissors Curved 17 cm
6	1	D 240.05	Dissecting Forcep Straight 20 cm
7	1	D 360.06	Tissue Forcep Straight 20 cm
8	2	E 086.00	Foerster-ballenger Dressing-organ And Tissue Forcep 24 cm
9	3	E 158.00	Allis-thomas Organ And Tissue Grasping Forcep 4x7 Teeth 20 cm
10	1	E 365.02	Bozemann Uterine Forcep 25 cm
11	4	E 430.02	Backhaus Towel Clamp 13.5 cm
12	1	F 363.02	Finochetto Needle Holder 26.5 cm
13	4	G 215.00	Halsted-mosquito Delicate Haemostatic Forcep Curved 12.5 cm
14	3	G 430.02	Rochester-pean Haemostatic Forcep Straight 20 cm
15	2	K 614.01	Simon Vaginal Retractor 115x22 Mm 27.5 cm
16	1	K 832.01	Sims Vaginal Specula 70x25/75x30 Mm 12.5 cm
17	1	K 832.05	Sims Vaginal Specula 75x30/180x35 Mm 15 cm
18	1	K 832.08	Sims Vaginal Specula 80x36/90x40 Mm 17.5 cm
19	1	K 863.01	Sims Vaginal Specula 75x42-40 Mm 1470 Gr. 23 cm
20	1	Y 290.07	Wire Basket, 405x255x70 mm
21	1	Y 210.10	1/2 Size Container, 465x280x100 mm

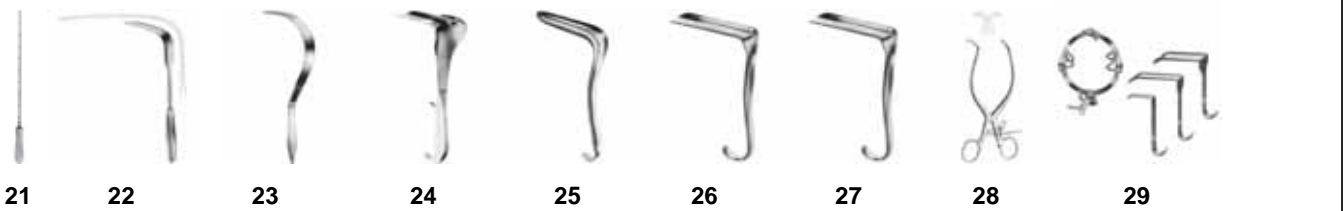
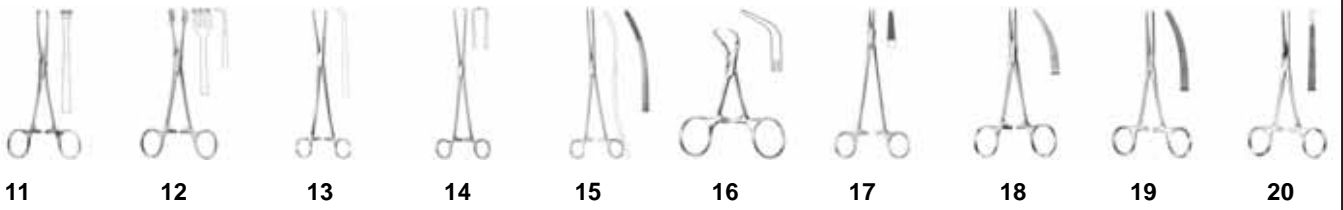
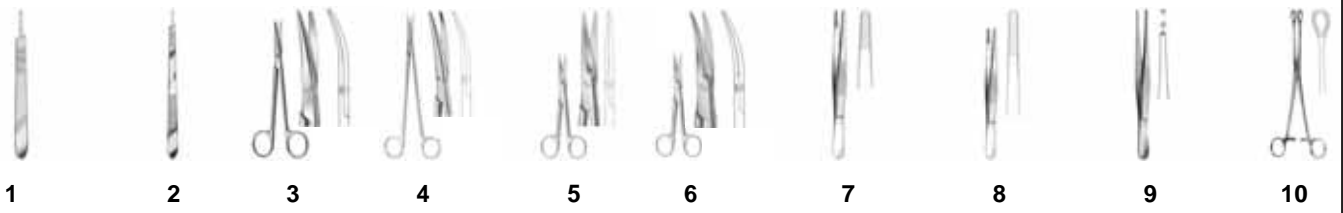

No	Quantity	Code	Description
1	1	B 030.01	Scalpel Handle 3 No 13.5 cm
2	1	B 030.02	Scalpel Handle 3 No 21.5 cm
3	1	C 421.01	Metzenbaum Dissecting Scissors Curved 18 cm
4	1	C 423.00	Nelson-metzenbaum Dissecting Scissors Curved 23 cm
5	1	C 440.01	Mayo Surgical Scissors Straight 15.5 cm
6	1	C 441.01	Mayo Surgical Scissors Curved 15.5 cm
7	2	D 240.02	Dissecting Forcep 14.5 cm
8	2	D 240.05	Dissecting Forcep 20 cm
9	2	D 360.03	Tissue Forcep 14.5 cm
10	2	E 086.00	Foerster-ballenger Dressing Organ And Tissue Forcep 24 cm
11	6	E 144.00	Allis Dressing Organ And Tissue Forcep 5x6 Teeth 15.5 cm
12	2	E 201.00	Uterine Tenaculum Forcep 9 Mm 15.5 cm
13	1	E 251.00	Schröder Uterine Tenaculum Forcep 25 cm
14	1	E 258.01	Braun Uterine Tenaculum Forcep 25 cm
15	2	E 365.02	Bozemann Uterine Forcep Curved 25 cm
16	6	E 430.02	Backhaus Towel Clamp 13.5 cm
17	1	F 355.01	Hegar-mayo Needle Holder 18 cm
18	12	G 241.00	Crille Delicate Haemostatic Forcep Curved 14 cm
19	12	G 431.00	Rochester-pean Haemostatic Forcep Curved 16 cm
20	6	G 448.02	Kocher-ochsner Haemostatic Forcep Straight 20 cm
21	1	J 650.05	Mayo Uterine Probe Malleable 33 cm
22	1	K 614.02	Simon Vaginal Retractor 115 X 26 mm 27.5 cm
23	1	K 660.01	Deaver Retractor 18 cm
24	1	K 706.03	Doyen Vaginal Specula 112x45 mm 23.5 cm
25	1	K 812.04	Kristeller Vaginal Specula 110x18 mm 21.5 cm
26	1	K 819.02	Jackson Vaginal Specula 76x38 mm 17.5 mm
27	1	K 819.03	Jackson Vaginal Specula 89x38 mm 17.5 mm
28	2	L 409.00	Gelpi Vaginal Retractor 17.5 mm
29	1	L 418.00	O'sullivan-O'connor Vaginal Retractor Complete (L 418.01-I 418.03-I 418.04-I 418.05
30	1	Y 210.13	3/4 Size Container 465 X 280 X 135 mm
31	1	Y 290.07	3/4 Wire Basket 405 X 255 X 70 mm



1



2



3



4



5



6



7



8



9



10



11



12



13



14



15



16



17



18

No	Quantity	Code	Description
1	1	B 030.01	Scalpel Handle 3 No 13.5 cm
2	1	C 421.01	Metzenbaum Dissecting Scissors 18 cm
3	1	C 440.02	Mayo Surgical Scissors Straight 17 cm
4	1	C 441.02	Mayo Surgical Scissors Curved 17 cm
5	2	D 240.02	Dissecting Forcep 14.5 cm
6	1	D 240.05	Dissecting Forcep 20 cm
7	2	D 360.03	Tissue Forcep Straight 14.5 cm
8	1	D 360.06	Tissue Forcep Straight 20 cm
9	4	E 144.00	Allis Dressing Organ And Tissue Forcep 5x6 Teeth 15.5 cm
10	1	F 355.01	Hegar-mayo Needle Holder 18 cm
11	1	F 355.02	Hegar-mayo Needle Holder 20.5 cm
12	6	G 234.00	Kelly Delicate Haemostatic Forcep Straight 14 cm
13	6	G 235.00	Kelly Delicate Haemostatic Forcep Curved 14 cm
14	12	G 431.00	Rochester-pean Haemostatic Forcep Curved 16 cm
15	4	G 448.02	Kocher-ochsner Haemostatic Forcep Straight 20 cm
16	1	L 409.00	Gelpi Vaginal Retractor 17.5 cm
17	1	Y 310.10	1/2 Size Container 285 X 280 X 100 mm
18	1	Y 390.05	1/2 Wire Basket 255 X 245 X 50 mm

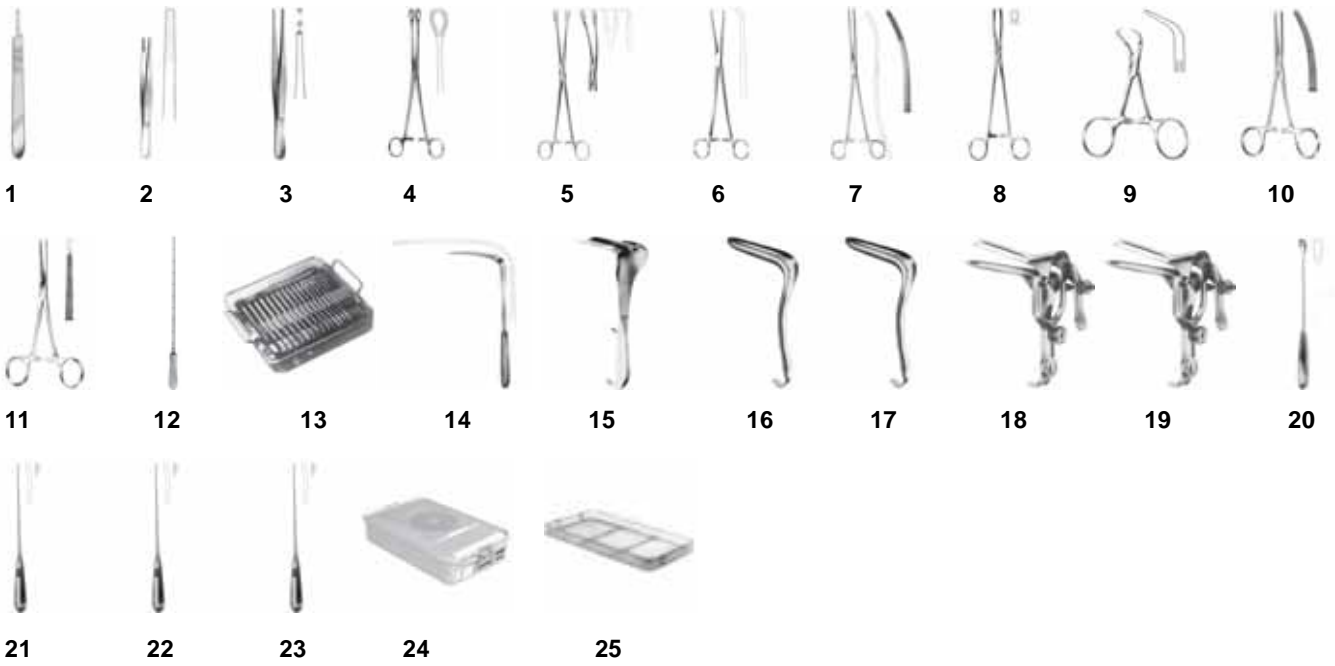

No	Quantity	Code	Description
1	1	B 030.01	Scalpel Handle 3 No 13.5 cm
2	1	D 240.06	Dissecting Forcep 25 cm
3	1	D 360.03	Tissue Forcep Straight 14.5 cm
4	3	E 086.00	Foerster-ballenger Dressing Forcep 24 cm
5	1	E 216.02	Schröder Uterine Tenaculum Forcep 10 Mm 25 cm
6	1	E 251.00	Schröder Uterine Tenaculum Forcep 25 cm
7	1	E 365.02	Bozemann Uterine Forcep 25 cm
8	1	E 376.01	Jacobs Uterine Tenaculum Forcep 21.5 cm
9	4	E 430.02	Backhaus Towel Clamp 13.5 cm
10	2	G 431.00	Rochester-pean Haemostatic Forcep Curved 16 cm
11	2	G 448.01	Kocher-ochsner Haemostatic Forcep Straight 18.5 cm
12	1	J 650.05	Mayo Uterine Probe Malleable 33 cm
13	1	J 790.00	Uterine Dilator Sets (J 750.04-j 750.17/Y 310.10, Y 390.05)
14	2	K 614.01	Simon Vaginal Specula 27.5 cm
15	1	K 706.02	Doyen Vaginal Specula 23.5 cm
16	1	K 812.04	Kristeller Vaginal Specula Lower Blade 21.5 cm
17	1	K 812.06	Kristeller Vaginal Specula Lower Blade 22.5 cm
18	1	L 790.02	Grave Vaginal Specula 95x30 mm
19	1	L 790.03	Grave Vaginal Specula 105x33 mm
20	1	N 510.12	Gourdet Uterine Scoop 12 Mm 28 cm
21	1	N 525.15	Recamier Uterine Scoop Sharp-malleable 12 Mm 30 cm
22	1	N 528.08	Recamier Uterine Scoop Blunt-rigid 7.5 Mm 30 cm
23	1	N 528.09	Recamier Uterine Scoop Blunt-rigid 8.5 Mm 30 cm
24	1	Y 210.10	3/4 Size Container 465 X 280 X 100 mm
25	1	Y 290.05	3/4 Wire Basket 405 X 255 X 50 mm





Biopsy of Cervix Set

No	Quantity	Code	Description
1	1	B 030.02	Scalpel Handle 3 No 21.5 cm
2	1	C 441.02	Mayo Surgical Scissors 17 cm
3	1	D 360.06	Tissue Forcep Straight 20 cm
4	1	N 580.02	Randall Biopsy Curette 24 cm
5	1	R 750.01	Tischler Biopsy Forcep 20 cm
6	1	Y 390.03	1/2 Wire Basket 255 X 245 X 30 mm
7	1	Y 310.05	Flat Container 285 X 280 X 55 mm

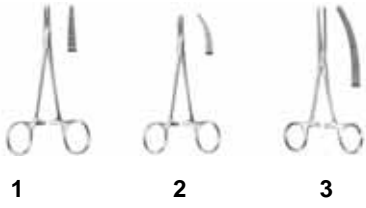

No	Quantity	Code	Description
1	12	G 214.00	Halsted-mosquito Delicate Haemostatic Forcep Straight 12.5 cm
2	12	G 215.00	Halsted-mosquito Delicate Haemostatic Forcep Curved 12.5 cm
3	6	G 431.00	Rochester-pean Haemostatic Forcep Curved 16 cm

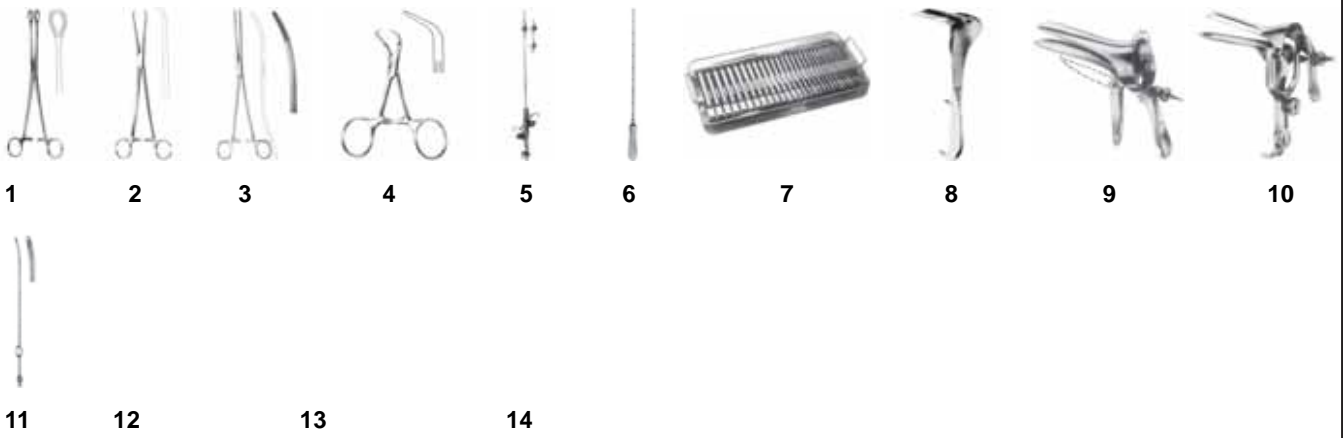

No	Quantity	Code	Description
1	1	E 086.00	Foerster-ballenger Dressing Forcep 24 cm
2	2	E 251.00	Schröder Uterine Tenaculum Forcep 25 cm
3	2	E 365.02	Bozemann Uterine Forcep 25 cm
4	5	E 430.02	Backhaus Towel Clamp 13.5 cm
5	1	J 490.00	Schulze Vacuum Curette Complete(J 490.01, J 490.02, J 490.03, J 490.04)
6	1	J 650.05	Mayo Uterine Probe Malleable 33 cm
7	1	J 792.00	Uterine Dilators Set [(J 750.04 - J 750.17)+(J 751.04-J 751.17) With Y 110.10-Y 191.05]
8	1	K 706.02	Doyen Vaginal Specula 90x45 mm 23.5 cm
9	1	L 765.02	Cusco Vaginal Specula 90x37 mm
10	1	L 790.03	Grave Vaginal Specula 105x33 mm
11	1	N 580.02	Randall Biopsy Curettes 24 cm
12	1	Y 110.15	1/1 Size Container Basic Model 580 X 280 X 150 mm
13	1	Y 191.05	1/1 Wire Basket 540 X 255 X 50 mm
14	1	Y 191.07	1/1 Wire Basket 540 X 255 X 70 mm



1



2



3



4



5



6



7



8



9



10



11



12



13



14



15



16



17



18



19



20



21



22



23



24



25



26



27



28



29

No	Quantity	Code	Description
1	1	A 202.00	Scalpel Handle, 3 No, 13.5 cm
2	1	C 310.03	Surgical Scissors 14.5 cm
3	1	C 440.02	Mayo Surgical Scissors 17 cm
4	1	C 600.00	Scissors For Obstetric 10.5 cm
5	1	C 604.00	Braun-stadler Obstetric Scissors 20 cm
6	1	D 240.02	Dissecting Forcep 14.5 cm
7	1	D 390.01	Russ Modell Dissecting Forcep 20 cm
8	4	E 086.00	Foerster-ballenger Dressing Forcep 24 cm
9	1	E 122.00	Kelly Polypus And Ovum Forcep 32 cm
10	4	E 144.00	Allis Dressing Organ And Tissue Forcep 5x6 Teeth 15.5 cm
11	2	E 251.00	Schröder Uterine Tenaculum Forcep 25 cm
12	2	E 365.02	Bozemann Uterine Forcep 25 cm
13	1	E 389.02	Iowa Instrumente For Obstetric 26 cm
14	6	E 430.02	Backhaus Towel Clamp 13.5 cm
15	1	E 565.02	Kielland Obstetrical Forcep 42 cm
16	1	E 567.02	Piper Obstetrical Forcep 44.5 cm
17	1	E 569.02	Kielland-luikard Obstetrical Forcep 40 cm
18	1	E 572.02	Mc Lean Obstetrical Forcep 36 cm
19	1	E 578.04	Tarnier Obstetrical Forcep 40 cm
20	1	F 355.01	Hegar-mayo Needle Holder 18 cm
21	1	F 355.02	Hegar-mayo Needle Holder 20.5 cm
22	2	G 240.00	Crille Delicate Haemostatic Forcep Straight 14 cm
23	6	G 241.00	Crille Delicate Haemostatic Forcep Curved 14 cm
24	1	G 430.00	Rochester-pean Haemostatic Forcep Straight 16 cm
25	2	G 431.00	Rochester-pean Haemostatic Forcep Curved 16 cm
26	2	K 819.03	Jackson Vaginal Specula 89x38 Mm 17.5 cm
27	1	L 409.00	Gelpi Vaginal Retractor 17.5 cm
28	1	Y 190.07	1/1 Wire Basket 485 X 255 X 70 mm
29	1	Y 110.10	1/1 Size Container 580 X 280 X 100 mm

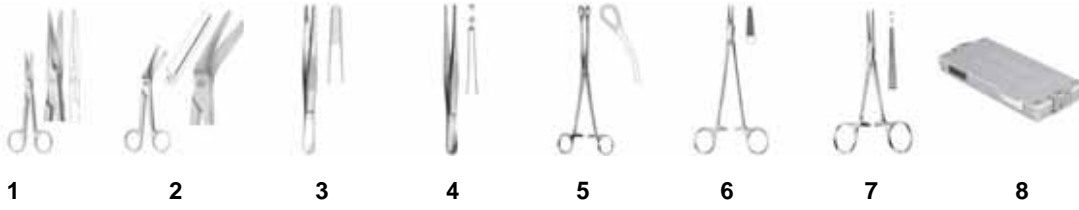

No	Quantity	Code	Description
1	1	C 440.02	Mayo Surgical Scissors 17 cm
2	1	C 604.00	Braun-stadler Obstetric Scissors 20 cm
3	1	D 240.02	Dissecting Forcep 14.5 cm
4	1	D 360.03	Tissue Forcep Straight 14.5 cm
5	2	E 087.00	Foerster-ballenger Dressing Forcep 24 cm
6	1	F 355.02	Hegar-mayo Needle Holder 20.5 cm
7	2	G 244.00	Crile Delicate Haemostatic Forcep 14 cm
8	1	Y 410.04	Mini Container 300X140X40 mm

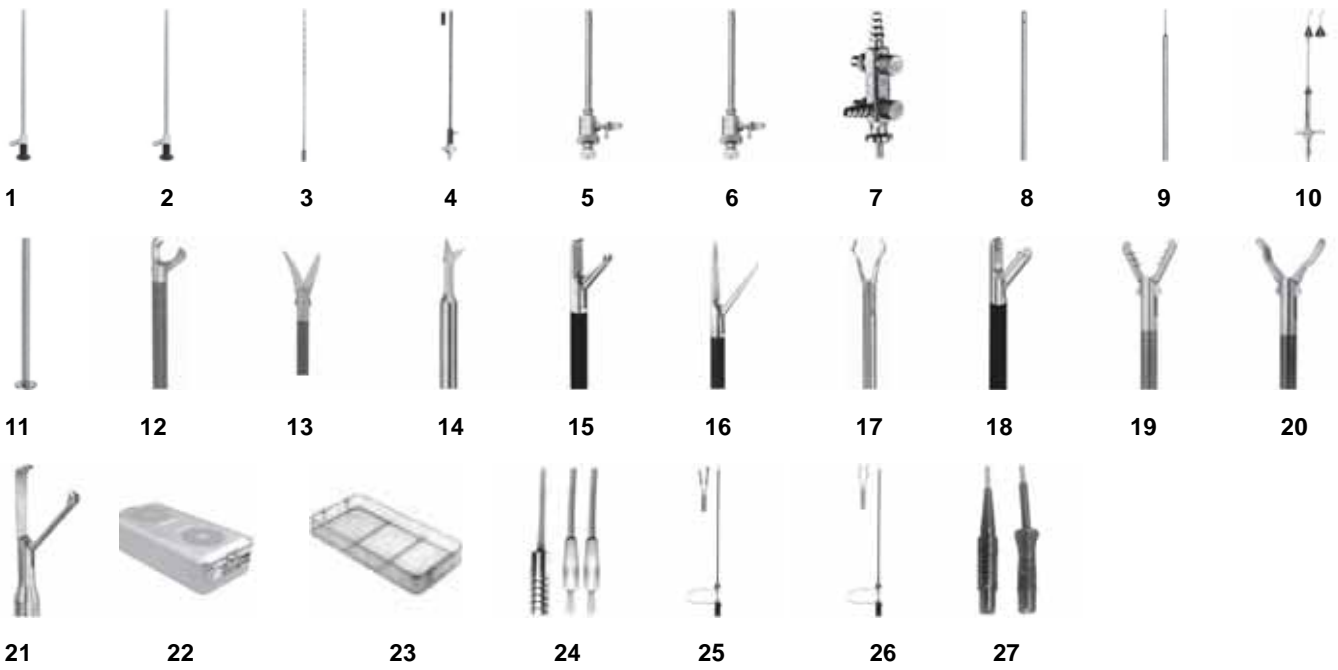

No	Quantity	Code	Description
1	1	A 908.30	Telescope Standart 30° Ø10 Mm 31 cm
2	1	A 909.30	Telescope Autoclavable 30° Ø10 Mm 31 cm
3	1	H 810.01	Exploratory Probe 33 cm
4	1	J 140.04	Elektrosurgical Instrument Button Elektrode
5	2	J 153.03	Sleeves Only Ø 5.5 mm
6	2	J 155.03	Sleeves Only Ø 11 mm
7	1	J 161.00	Interchangeable Handle With Two Valve 33 cm
8	1	J 171.01	Suction Ifrigation Tube
9	1	J 171.06	Suction Ifrigation Tube
10	1	J 952.00	Cohen Uterine Cannula
11	1	T 802.06	Reducer Instrument 11 - 5.5 mm
12	1	X 100.03	Hook Scissors Standart Curved Insulated 5 mm
13	1	X 113.03	Metzenbaum Hook Scissors Rotation Insulated Curved 5 mm
14	1	X 118.01	Micro Scissors Standart Curved Uninsulated 5 mm
15	1	X 174.04	Cobra Grasping Forcep Modular Insulated Ratchet 5 mm
16	1	X 177.03	Needlenose Grasping Forcep Modular Insulated Delicate Jaw 5 mm
17	1	X 199.02	Atromatic Grasping Forcep Standart Uninsulated-ratchet 5 mm
18	1	X 506.03	Biopsy Forcep Standart Insulated With Pin 5 mm
19	1	X 530.01	Grasping Forcep Standart Uninsulated 5 mm
20	1	X 536.01	Dissecting Forcep Standart Uninsulated 5 mm
21	1	X 617.02	Claw Forcep Modular Uninsulated-ratchet 10 mm
22	1	Y 110.13	1/1 Size Container Basic Model 580 X 280 X 150 mm
23	1	Y 191.07	1/1 Wire Basket 540 X 255 X 70 mm
24	1	Z 065.00	Electrosurgical Instrument Bipolar Cord 2 mt.
25	1	Z 300.01	Bipolar Coagulation Eleckrosurgical Forcep Modular Spring Insulated 33 cm
26	1	Z 303.01	Bipolar Coagulation Eleckrosurgical Forcep Modular Spring Insulated 33 cm
27	1	Z 309.00	Instrument Cable For Detachable

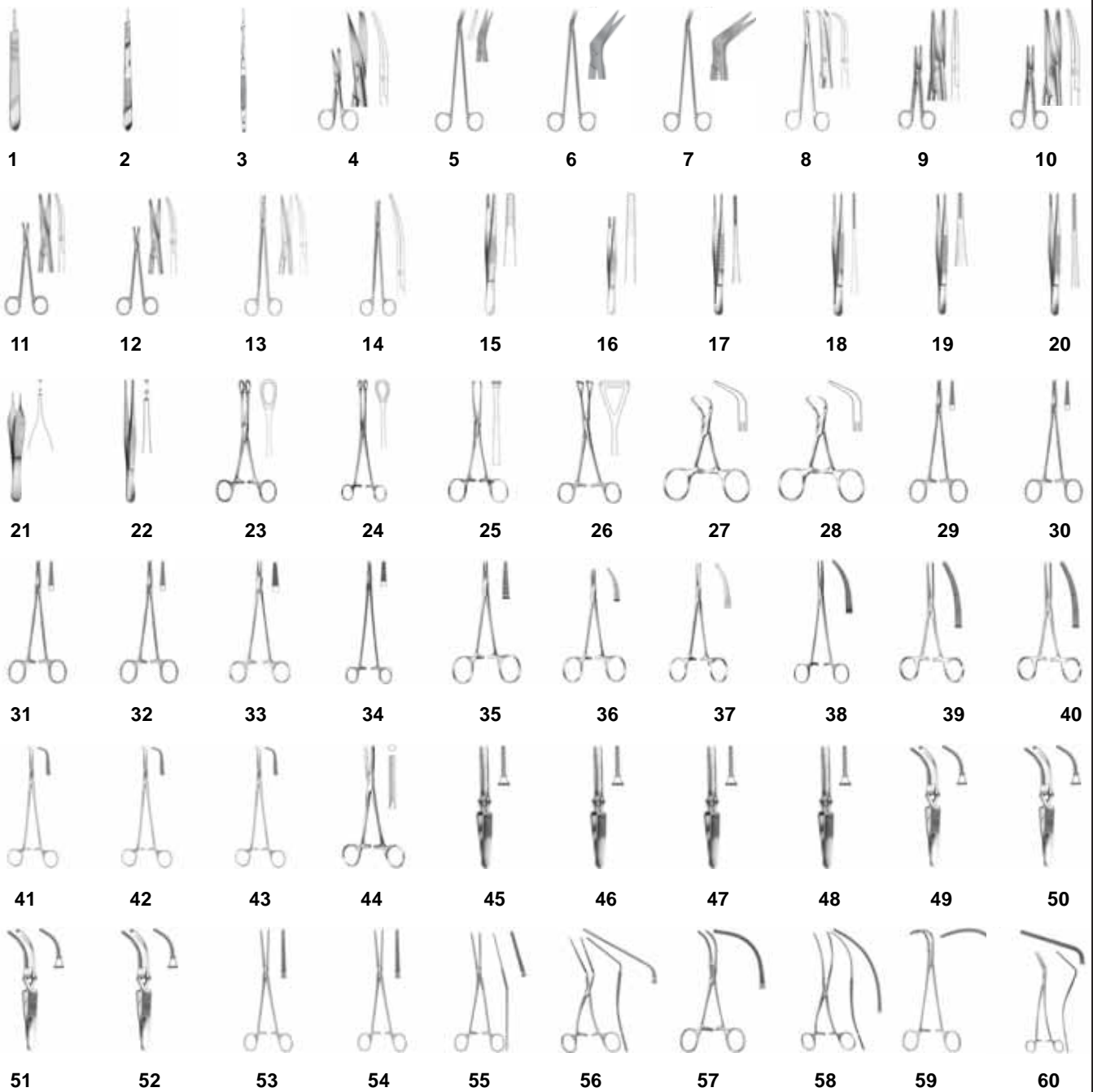

No	Quantity	Code	Description
1	1	B 030.01	Scalpel Handle 3 no 13.5 cm
2	1	B 030.02	Scalpel Handle 3 no 21.5 cm
3	1	B 032.00	Scalpel Handle 16.5 cm
4	1	C 311.03	Surgical Scissors Curved 14.5 cm
5	1	C 506.00	Potts-De Martel Vascular Scissors 30° 18.5 cm
6	2	C 506.01	Potts-De Martel Vascular Scissors 45° 18.5 cm
7	2	C 506.02	Potts-De Martel Vascular Scissors 60° 18.5 cm
8	1	C 569.00	Thorek Cardiovascular Surgery Scissors Curved 18 cm
9	1	C 725.01	Mayo Delicate Scissors HM Straight 17 cm
10	1	C 726.01	Mayo Delicate Scissors HM Curved 17 cm
11	1	C 756.00	Metzenbaum Dissecting Scissors HM Curved 14.5 cm
12	2	C 756.01	Metzenbaum Dissecting Scissors HM Curved 18 cm
13	1	C 761.00	Nelson-Metzenbaum Scissors HM Curved 23 cm
14	1	C 761.01	Nelson-Metzenbaum Scissors HM Curved 30 cm
15	2	D 240.03	Standart Dissecting Forcep Straight 16 cm
16	2	D 240.06	Standart Dissecting Forcep Straight 25 cm
17	2	D 262.01	De Bakey Forcep 2 mm 20 cm
18	2	D 262.02	De Bakey Forcep 2 mm 24 cm
19	2	D 263.01	De Bakey Forcep 2.7 mm 20 cm
20	2	D 263.02	De Bakey Forcep 2 mm 24 cm
21	3	D 323.00	Adson Micro Suture Tying Forcep 12 cm
22	2	D 360.04	Standart Forcep 16 cm
23	2	E 082.00	Foerster-Ballanger Tissue Grasping Forcep 18 cm
24	4	E 086.00	Foerster-Ballanger Tissue Grasping Forcep 24 cm
25	6	E 144.00	Allis Tissue Grasping Forcep 5x6 Teeth 15.5 cm
26	4	E 187.01	Collin Tissue Grasping Forcep 23 cm
27	24	E 430.00	Backhaus Towel Clamp 9 cm
28	10	E 430.02	Backhaus Towel Clamp 13.5 cm
29	2	F 346.00	De Bakey Needle Holder HM 0.4 18 cm
30	2	F 346.01	De Bakey Needle Holder HM 0.4 23 cm
31	2	F 346.02	De Bakey Needle Holder HM 0.4 25 cm
32	1	F 346.03	De Bakey Needle Holder HM 0.4 30.5 cm
33	4	F 355.01	Hegar Mayo Needle Holder 0.5 18 cm
34	2	F 357.01	Hegar Needle Holder 0.5 24.5 cm
35	6	G 214.00	Halsted Masquito Delicate Haemostatic Forcep Straight 12.5 cm
36	12	G 215.00	Halsted Masquito Delicate Haemostatic Forcep Curved 12.5 cm
37	18	G 251.00	Leriche Delicate Haemostatic Forcep Curved 14 cm
38	6	G 301.00	Heiss Delicate Haemostatic Forcep Curved 20 cm
39	12	G 431.00	Rochester-Pean Haemostatic Forcep Curved 16 cm
40	4	G 431.03	Rochester-Pean Haemostatic Forcep Curved 22.5 cm
41	1	G 644.02	Gemini Dissecting and Ligature Forcep 18 cm
42	1	G 644.04	Gemini Dissecting and Ligature Forcep 23 cm
43	1	G 644.06	Gemini Dissecting and Ligature Forcep 28 cm
44	6	G 884.02	Tubing Clamp Forceps 20 cm
45	2	H 120.00	De Bakey Bulldog Clamp Straight 8 cm
46	2	H 120.01	De Bakey Bulldog Clamp Straight 9 cm
47	2	H 120.02	De Bakey Bulldog Clamp Straight 10.5 cm
48	2	H 120.03	De Bakey Bulldog Clamp Straight 12.5 cm
49	2	H 121.00	De Bakey Bulldog Clamp Curved 7.5 cm
50	2	H 121.01	De Bakey Bulldog Clamp Curved 8.5 cm
51	2	H 121.02	De Bakey Bulldog Clamp Curved 9.5 cm
52	2	H 121.03	De Bakey Bulldog Clamp Curved 11.5 cm
53	2	H 420.00	De Bakey Coarctation Clamp Straight 41 mm 20.5 cm
54	4	H 420.01	De Bakey Coarctation Clamp Straight 65 mm 22.5 cm
55	2	H 421.00	De Bakey Coarctation Clamp Angled 15° 41 mm 20.5 cm
56	6	H 433.00	De Bakey Peripheral Vascular Clamp 60° 77x65 mm 18 cm
57	2	H 450.00	De Bakey Peripheral Vascular Clamp 56 mm 16 cm
58	2	H 451.01	De Bakey Peripheral Vascular Clamp 92.5 mm 20 cm
59	2	H 452.00	Glover Anastomosis Clamp 70 mm 19.5 cm
60	2	H 461.00	De Bakey(Morris Modif.) Angled 70° 70 mm 24 cm

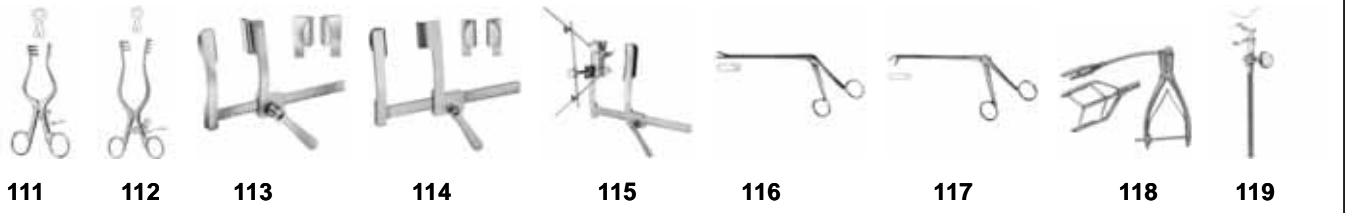
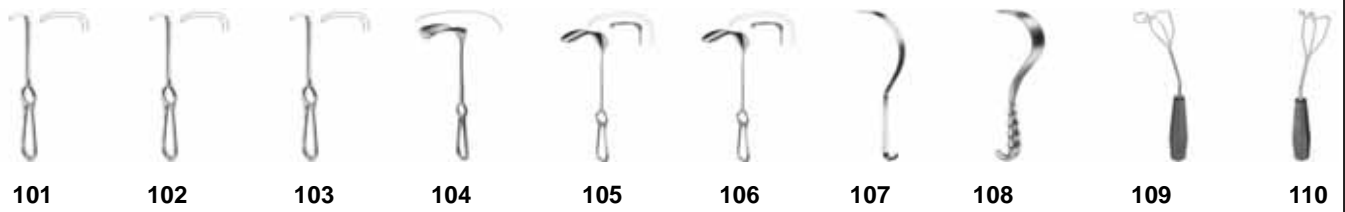
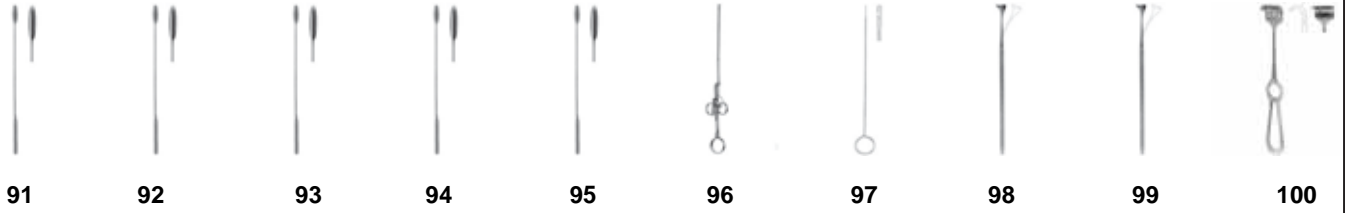
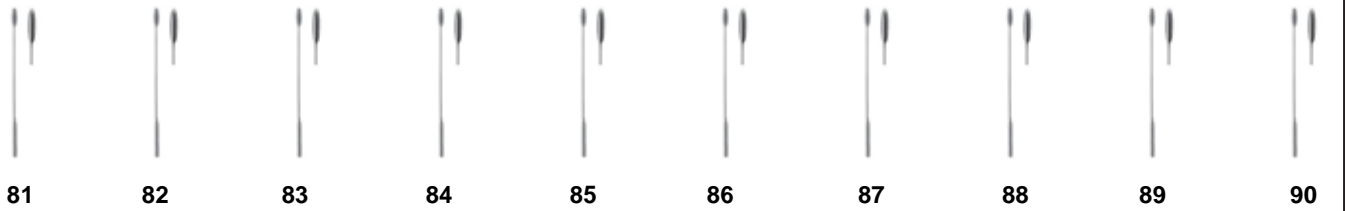
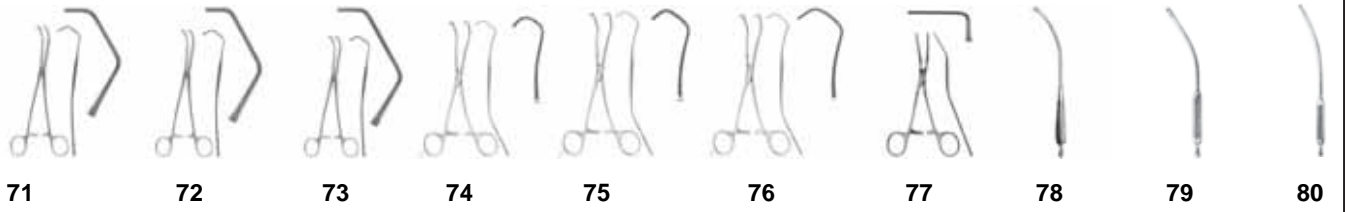
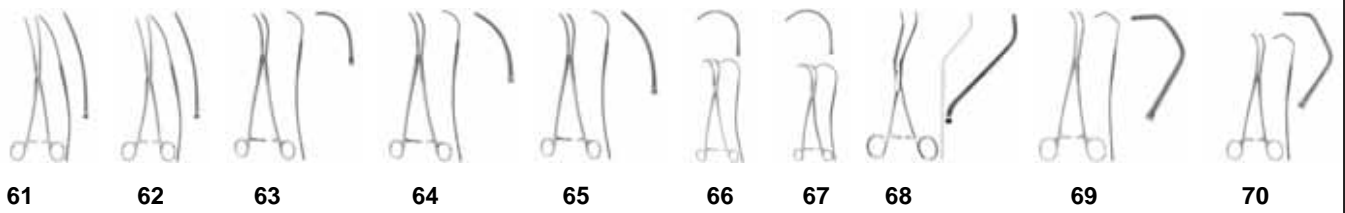

No	Quantity	Code	Description
61	2	H 465.01	De Bakey Aorta Aneurysm Clamp 2x3 teeth 110 mm 30 cm
62	2	H 465.02	De Bakey Aorta Aneurysm Clamp 2x3 teeth 130 mm 31.5 cm
63	1	H 477.00	De Bakey Aorta Aneurysm Clamp 70 mm 25.5 cm
64	1	H 477.01	De Bakey Aorta Aneurysm Clamp 75 mm 26.5 cm
65	1	H 477.02	De Bakey Aorta Aneurysm Clamp 85 mm 28 cm
66	1	H 480.00	De Bakey(Semb Modif.) Aorta Aneurysm Clamp 100 mm 26.5 cm
67	2	H 481.00	De Bakey Aorta Aneurysm Clamp 111 mm 27 cm
68	2	H 563.00	Henly Anastomosis Clamp 88 mm 19.5 cm
69	1	H 570.00	De Bakey Tangential Occlusion Clamp 38x85 mm 22 cm
70	1	H 570.01	De Bakey Tangential Occlusion Clamp 48x95 mm 26.5 cm
71	1	H 570.02	De Bakey Tangential Occlusion Clamp 54x99 mm 27 cm
72	1	H 570.03	De Bakey Tangential Occlusion Clamp 58x103 mm 27 cm
73	1	H 570.04	De Bakey Tangential Occlusion Clamp 75x119 mm 27 cm
74	1	H 630.00	Derra-Cooley Anastomosis Clamp 16x71 mm 17 cm
75	1	H 630.01	Derra-Cooley Anastomosis Clamp 21x76 mm 17.5 cm
76	1	H 630.02	Derra-Cooley Anastomosis Clamp 27x80 mm 17.5 cm
77	3	H 640.00	Cooley Multi Purpose Clamp Angled 30° 35x48 mm 15 cm
78	1	J 301.00	Yankauer Cannulae Ø10 mm 28.5 cm
79	1	J 302.00	Cooley Cannulae Ø8 mm 31 cm
80	1	J 303.00	Cooley Cannulae Ø8 mm 36 cm
81	1	J 510.02	De Bakey Dilator Malleable Ø 0.5 mm 19 cm
82	1	J 510.03	De Bakey Dilator Malleable Ø 1.0 mm 19 cm
83	1	J 510.04	De Bakey Dilator Malleable Ø 1.5 mm 19 cm
84	1	J 510.05	De Bakey Dilator Malleable Ø 2.0 mm 19 cm
85	1	J 510.06	De Bakey Dilator Malleable Ø 2.5 mm 19 cm
86	1	J 510.07	De Bakey Dilator Malleable Ø 3.0 mm 19 cm
87	1	J 510.08	De Bakey Dilator Malleable Ø 3.5 mm 19 cm
88	1	J 510.09	De Bakey Dilator Malleable Ø 4.0 mm 19 cm
89	1	J 510.10	De Bakey Dilator Malleable Ø 4.5 mm 19 cm
90	1	J 510.11	De Bakey Dilator Malleable Ø 5.0 mm 19 cm
91	1	J 510.12	De Bakey Dilator Malleable Ø 7.0 mm 19 cm
92	1	J 510.13	De Bakey Dilator Malleable Ø 9.0 mm 19 cm
93	1	J 510.14	De Bakey Dilator Malleable Ø 6.0 mm 19 cm
94	1	J 510.15	De Bakey Dilator Malleable Ø 8.0 mm 19 cm
95	1	J 510.17	De Bakey Dilator Malleable Ø 10.0 mm 19 cm
96	2	J 530.01	Rumel-Belmont Tourniquets Ø 4.0 mm 32.5 cm
97	2	J 530.06	Rumel-Belmont Mandrin allein guide only
98	1	K 273.02	Marberger Retractor 8 mm 24 cm
99	1	K 273.03	Marberger Retractor 12 mm 24 cm
100	2	K 432.03	Volkman Retractor Sharp 9x29 mm 22 cm
101	1	K 451.02	Langenbeck Retractor 28x14 mm 21 cm
102	1	K 451.03	Langenbeck Retractor 33x14 mm 21 cm
103	2	K 451.04	Langenbeck Retractor 28x16 mm 21 cm
104	1	K 605.06	Kocher Retractor 80x60 mm 25 cm
105	1	K 608.01	Kocher -Wagner Retractor 36x20 mm 28 cm
106	1	K 608.02	Kocher -Wagner Retractor 64x25 mm 28 cm
107	1	K 660.04	Deaver Retractor 25 mm 30 cm
108	2	K 668.07	Deaver Retractor 50 mm 30.5 cm
109	1	K 695.02	Cooley Retractor Slightly Serrated 45x48 mm 26.5 cm
110	1	K 697.02	Cooley Retractor Left 25x46 mm 28 cm
111	2	L 304.00	Weitlaner Self-Retaining Retractor Sharp 13 cm
112	2	L 312.00	Weitlaner Self-Retaining Retractor Sharp 16.5 cm
113	1	L 828.02	Cooley Rib Spreader 14x14.5x20 cm Blade 21x45 mm
114	1	L 828.04	Cooley Rib Spreader 18x19x29 cm Blade 32x50 mm
115	1	L 865.05	Mimimally Invasive Retractor 20.5x23 cm
116	1	R 375.01	Caspar Rongeur 3 mm 15.5 cm
117	1	R 379.01	Caspar Rongeur 150° 3 mm 15.5 cm
118	1	R 860.01	Tubbs Aortic Dilator Blade opening 8-42 mm
119	1	T 852.00	Bailey Rib Spreader 20 cm
120	2	Y 190.07	Wire Basket, 485x255x70 mm
121	1	Y 111.20	1/1 Size Container, 580x280x200 mm

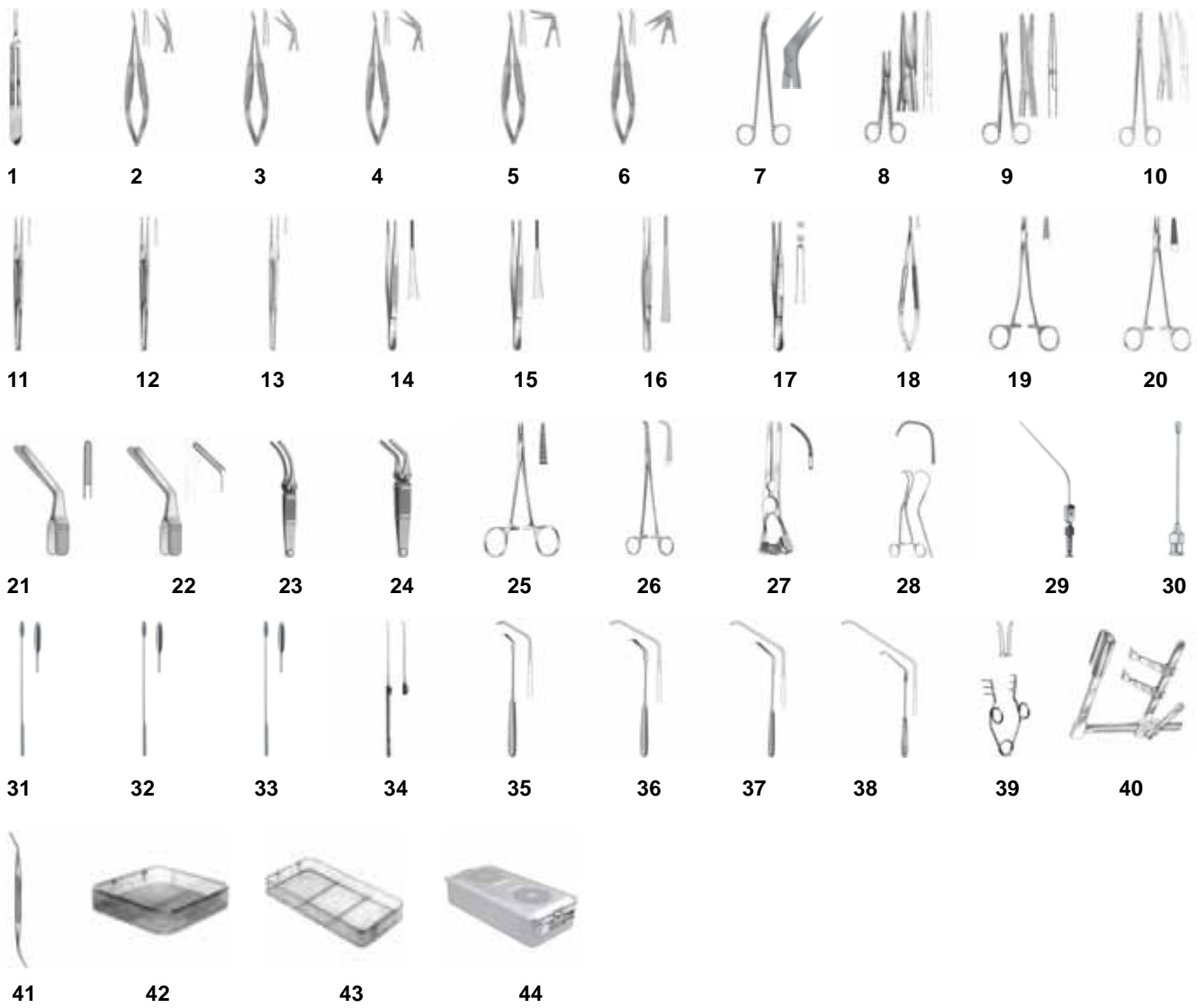

No	Quantity	Code	Description
1	1	B 040.01	Scalpel Handle 4 No 13.5 cm
2	1	C 135.00	Vascular Scissors 25° 18.5 cm
3	1	C 135.01	Vascular Scissors 45° 18.5 cm
4	1	C 135.03	Vascular Scissors 60° 18.5 cm
5	1	C 135.04	Vascular Scissors 90° 18.5 cm
6	1	C 135.06	Vascular Scissors 125° 18.5 cm
7	1	C 506.01	Potts-De Martel Vascular Scissors 45° 18.5 cm
8	1	C 725.01	Mayo Delicate Scissors Straight 17 cm
9	1	C 755.00	Metzenbaum Dissecting Scissors Straight 14.5 cm
10	1	C 761.00	Nelson-Metzenbaum(Mc Indore) Scissors Curved 23 cm
11	1	D 162.11	Micro Tissue Forcep Ø 0.5x1.0 mm 18 cm
12	1	D 162.21	Micro Tissue Forcep Ø 1.3x2.0 mm 18 cm
13	1	D 186.07	Micro Tissue Forcep Ø 0.8x6.0 mm 21 cm
14	1	D 265.00	De Bakey Forcep 1.5 mm 15 cm
15	1	D 265.01	De Bakey Forcep 1.5 mm 20 cm
16	1	D 265.02	De Bakey Forcep 1.5 mm 24 cm
17	1	D 370.02	Tissue Forcep 16 cm
18	1	F 156.23	Micro Needle Holder With catch 0.8x11 mm 20.5 cm
19	1	F 338.00	Sarot Needle Holder 17.5 cm
20	1	F 355.00	Hegar-Mayo Needle Holder 15 cm
21	2	G 037.01	Featherlight Bulldog Clamp 14 mm 3.5 cm
22	2	G 038.01	Featherlight Bulldog Clamp 14 mm 3.3 cm
23	2	G 041.00	De Bakey Bulldog Clamp Curved 5.5 cm
24	2	G 042.00	De Bakey Bulldog Clamp Angled 55° 5 cm
25	10	G 214.00	Halsted Masquito Delicate Haemostatic Forcep Straight 12.5 cm
26	1	G 642.00	Mini-Gemini Dissecting Forcep 18 cm
27	2	H 137.00	De Bakey Bulldog Clamp Length of jaws 2.7 mm 4.8 cm
28	1	H 486.00	Lambert-Kay Aorta Anastomosis Clamp 40x93 mm 21.5 cm
29	2	J 214.01	Fergusson Suction Tube Ø 2.5 mm 18 cm
30	3	J 307.01	Heparin Cannulae Ø 3 mm 4.5 cm
31	1	J 510.03	De Bakey Dilator Malleable Ø 1 mm 19 cm
32	1	J 510.05	De Bakey Dilator Malleable Ø 2 mm 19 cm
33	1	J 510.06	De Bakey Dilator Malleable Ø 2.5 mm 19 cm
34	1	K 110.00	Krayenbülh Vessel Hook 18.5 cm
35	1	K 616.00	Zenker Retractor 36x8 mm 24 cm
36	1	K 616.02	Zenker Retractor 60x12 mm 25.5 cm
37	1	K 616.04	Zenker Retractor 75x12 mm 27 cm
38	1	K 616.06	Zenker Retractor 120x12 mm 29 cm
39	2	L 005.01	Self-Retaining Retractor 5.5 cm
40	1	L 869.00	Rib Spreader Retractor System Complete
41	1	M 158.01	Watson-Cheyne Dissector 18 cm
42	1	Y 390.03	Wire Basket, 255x245x30 mm
43	1	Y 190.07	Wire Basket, 485x255x70 mm
44	1	Y 110.13	1/1 Size Container, 580x280x135 mm



1



2



3



4



5



6



7



8



9



10



11



12



13



14



15



16



17



18



19



20



21



22



23



24

No	Quantity	Code	Description
1	1	C 135.01	Vascular Scissors 45° 18.5 cm
2	1	C 504.01	Diethrich-Hegemann Vascular Scissors 45° 18 cm
3	1	D 265.00	De Bakey Forcep 1.5 mm 15 cm
4	1	F 380.01	Ryder Needle Holder 15.5 cm
5	4	G 011.01	Diethrich Bulldog Clemp 4.5 cm
6	6	G 201.00	Baby-Mosquito Delicate Haemostatic Forcep Curved 10 cm
7	1	H 559.00	Anastomosis Clamp 13 cm
8	2	J 307.01	Heparin Cannulae Ø 3.0 mm 4.5 cm
9	1	J 513.00	De Bakey Dilator Ø 0.5 mm 14 cm
10	1	J 513.01	De Bakey Dilator Ø 1 mm 14 cm
11	1	J 513.02	De Bakey Dilator Ø 1.5 mm 14 cm
12	1	J 513.03	De Bakey Dilator Ø 2 mm 14 cm
13	1	J 513.04	De Bakey Dilator Ø 2.5 mm 14 cm
14	1	J 513.05	De Bakey Dilator Ø 3 mm 14 cm
15	1	J 513.06	De Bakey Dilator Ø 3.5 mm 14 cm
16	1	J 513.07	De Bakey Dilator Ø 4 mm 14 cm
17	1	J 513.08	De Bakey Dilator Ø 4.5 mm 14 cm
18	1	J 513.09	De Bakey Dilator Ø 5 mm 14 cm
19	1	J 513.11	De Bakey Dilator Ø 7 mm 14 cm
20	1	J 513.13	De Bakey Dilator Ø 9 mm 14 cm
21	2	L 088.00	Alm Self-Retaining Retractor Blunt 7 cm
22	1	L 301.00	Weitlaner Self-Retaining Retractor Blunt 11 cm
23	1	Y 390.05	Wire Basket, 255x245x50 mm
24	1	Y 310.10	1/2 Size Container, 285x280x100 mm



1



2



3



4



5



6



7



8



9



10



11



12



13



14

No	Quantity	Code	Description
1	1	F 355.00	Hegar-Mayo Needle Holder 15 cm
2	1	F 380.02	Ryder Needle Holder 17.5 cm
3	1	F 381.01	Ryder Needle Holder 17.5 cm
4	15	G 214.00	Halsted Masquito Delicate Haemostatic Forcep Straight 12.5 cm
5	1	K 647.00	Ross Retractor 16x15 mm 24 cm
6	1	K 647.01	Ross Retractor 23x13 mm 24 cm
7	1	K 647.02	Ross Retractor 24x16 mm 24 cm
8	1	K 647.03	Ross Retractor 27x13 mm 24 cm
9	1	K 647.04	Ross Retractor 27x27 mm 24 cm
10	1	K 647.05	Ross Retractor 25x39 mm 24 cm
11	1	R 331.01	Luc Rongeur 20 cm
12	1	R 410.00	Oldberg Rongeur Ø 7 mm 18 cm
13	1	Y 390.05	Wire Basket, 255x245x50 mm
14	1	Y 310.10	1/2 Size Container, 285x280x100 mm

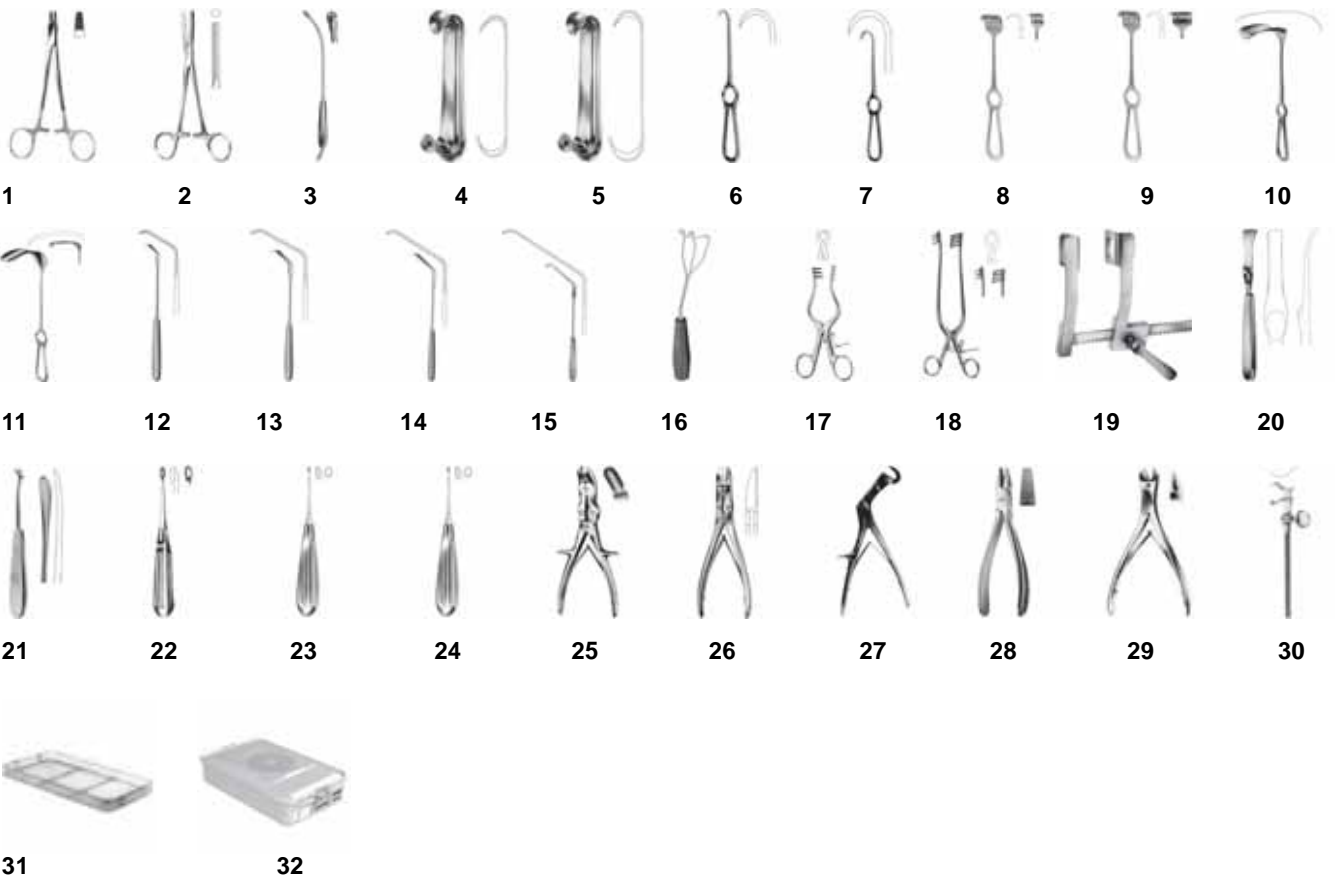

No	Quantity	Code	Description
1	1	F 334.00	Needle Holder 15 cm
2	6	G 884.02	Tubing Clamp Forceps 20 cm
3	2	J 304.00	De Bakey Cannulae Ø9 mm 27.5 cm
4	1	K 325.02	Roux Retractor 25x26-28x38 mm 16.5 cm
5	1	K 325.03	Roux Retractor 28x29-33x45 mm 16.5 cm
6	1	K 404.00	Volkman Retractor Sharp 22 cm
7	1	K 406.00	Volkman Retractor Sharp 20 cm
8	2	K 432.02	Volkman Retractor Sharp 9x19 mm 22 cm
9	2	K 432.03	Volkman Retractor Sharp 9x29 mm 22 cm
10	1	K 605.04	Kocher Retractor 80x42 mm 25 cm
11	2	K 608.01	Kocher -Wagner Retractor 36x20 mm 28 cm
12	1	K 616.00	Zenker Retractor 36x8 mm 24 cm
13	1	K 616.02	Zenker Retractor 60x12 mm 25.5 cm
14	2	K 616.04	Zenker Retractor 75x12 mm 27 cm
15	1	K 616.06	Zenker Retractor 120x12 mm 29 cm
16	2	K 697.02	Cooley Retractor Left 25x46 mm 28 cm
17	1	L 304.00	Weitlaner Self-Retaining Retractor Sharp 13 cm
18	1	L 354.02	Weitlaner Self-Retaining Retractor Blunt 24 cm
19	1	L 808.00	Finochietto Rib Spreader 14x17x20 cm Blade 36x45 mm
20	1	M 278.03	Lambotte Raspatories 15 mm 21.5 cm
21	1	M 289.05	Semb Raspatories 15 mm 23 cm
22	1	N 176.04	Schede Bone Curette 5.2 mm 17 cm
23	1	N 179.06	Wolkman Bone Curette 8.5 mm 17 cm
24	1	N 179.07	Wolkman Bone Curette 10 mm 17 cm
25	1	P 321.01	Luer-Stille Bone Rongeur 22.5 cm
26	1	P 370.00	Ruskin-Liston Bone Cutting Forcep 19 cm
27	1	P 502.01	Giertz-Stille Rib Scissors 25 cm
28	1	P 612.00	Wire Holding Forcep 17 cl
29	1	P 640.00	Reill Wire Cutting Forcep HM 17.5 cm
30	1	T 852.00	Bailey Rib Spreader 20 cm
31	1	Y 290.07	Wire Basket, 405x255x70 mm
32	1	Y 210.10	3/4 Size Container, 465x280x100 mm

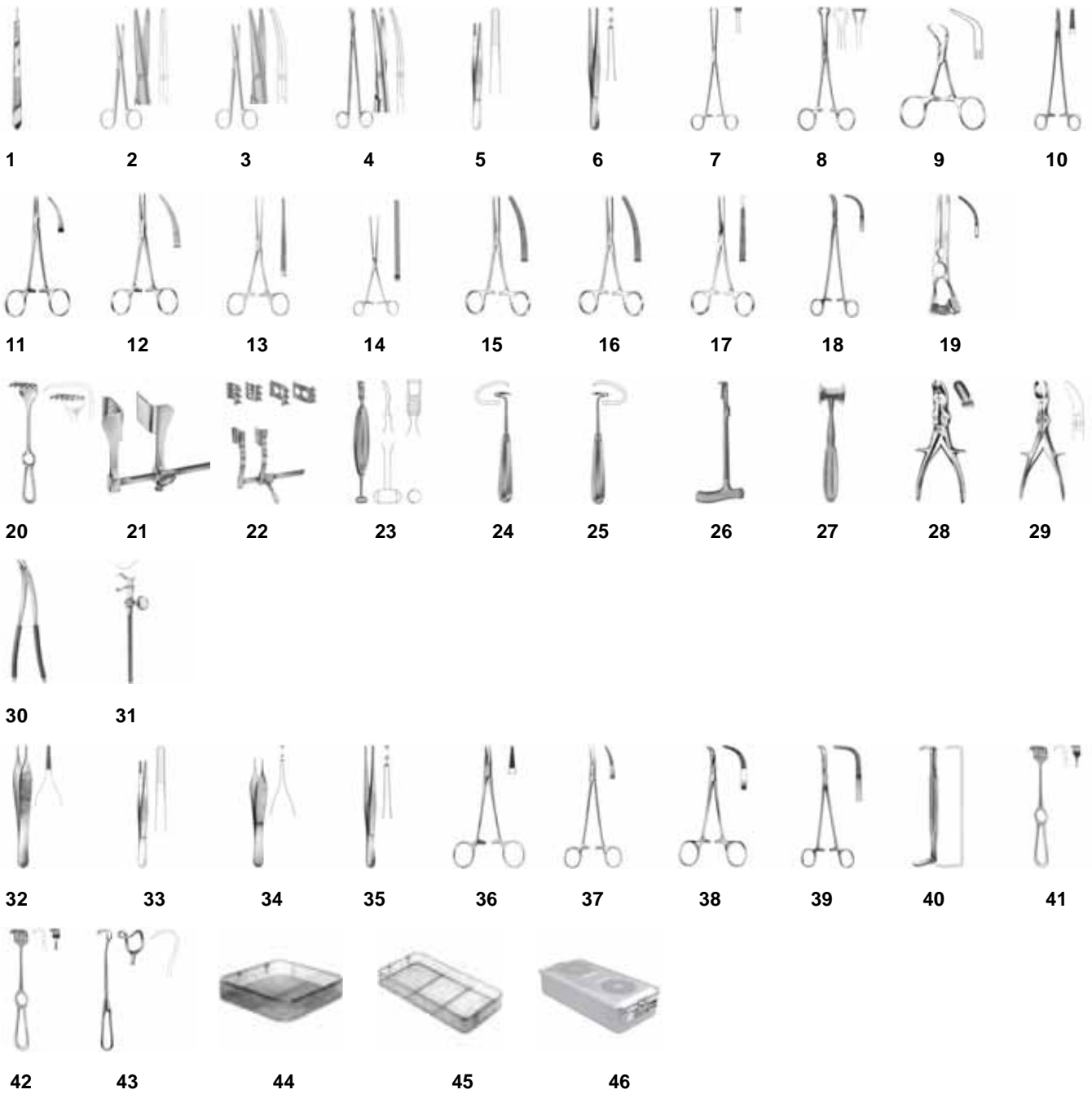

No	Quantity	Code	Description
----	----------	------	-------------

For abdominal and chest incision, Major Basic Instrument Set, Plus the Following

1	1	B 030.02	Scalpel Handle 3 no, 21.5 cm
2	1	C 458.01	Mayo Surgical Scissors, Straight, 20 cm
3	1	C 459.01	Mayo Surgical Scissors, Curved, 20 cm
4	1	C 768.01	Nelson-Metzenbaum Dissecting Scissors, HM, Curved, 28 cm
5	2	D 240.05	Standart Dissecting Forcep, 20 cm
6	2	D 360.06	Standart Tissue Forcep, 20 cm
7	6	E 147.01	Allis Tissue Grasping Forcep, 5x6 teeth, 19 cm
8	6	E 174.01	Babcook Organ and Tissue Grasping Forcep, 21.5 cm
9	12	E 430.00	Backhaus Towel Clamp, 9 cm
10	2	F 357.01	Hegar Needle Holder, HM, 24.5 cm
11	12	G 207.00	Micro-Halsted Delicate Haemostatic Forcep, Curved, 12.5 cm
12	12	G 241.00	Crile Delicate Haemostatic Forcep, Curved, 14 cm
13	2	G 330.00	Allen Intestinal Clamp, Straight, 15.5 cm
14	2	G 370.07	Kocher Intestinal Clamp, Elastic, Straight, 28 cm
15	12	G 431.00	Rochester-Pean Haemostatic Forcep, Curved, 16 cm
16	6	G 431.02	Rochester-Pean Haemostatic Forcep, Curved, 20 cm
17	6	G 448.02	Kocher-Ochsner Haemostatic Forcep, Straight, 1x2 teeth 20 cm
18	6	G 654.00	Mixer Ligature Forcep, Curved, 23 cm
19	4	H 137.02	Glomer Bulldog Clamp, Curved, 8 cm

Plus chest Onstrument as follows

20	2	K 444.01	Israel Retractor, Blunt, 47 x 51 mm, 25.5 cm
21	1	L 804.00	Tuffier Rib Spreader 12.5x13x17 mm, Bleyd 43x53 mm
22	1	L 812.00	Finochietto Rib Spreader, 22x21x26 cm, Blade 65 x 65 mm
23	1	M 285.00	Alexander Raspatorie, 12 mm, 21 cm
24	1	M 290.01	Doyen Raspatorie, 17.5 cm
25	1	M 291.01	Doyen Raspatorie, 17.5 cm
26	1	M 598.00	Lebsche Sternum Cutter, 20 cm
27	1	M 808.01	Hibbs Mallet, 340gr, 20 cm
28	1	P 321.01	Luer-Stille Bone Rongeurs 22.5 cm
29	1	P 377.01	Liston Bone Cutting Forcep, 28 cm
30	1	P 515.00	Bethune Rib Shear, 34 cm
31	1	T 852.00	Bailey Rib Spreader, 20 cm

For anstomosis of cervical end of esophagus, Minor Basic instrument Set, plus the following

32	1	D 205.00	Micro Adson Delicate Dissecting Forcep, 12 cm
33	1	D 240.05	Standart Dissecting Forcep, 20 cm
34	1	D 323.00	Adson Delicate Tissue Forcep, 12 cm
35	1	D 360.06	Standart Tissue Forcep, 20 cm
36	2	F 328.00	Baby-Crile-wood Needle Holder, HM, 15 cm
37	4	G 460.00	Schnidt Haemostatic Forcep, 18.5 cm
38	2	G 616.01	Baby-Mixer Ligature Forcep, Curved, 18 cm
39	2	G 674.01	Mixer Dissecting Forcep, 25 cm
40	1	K 342.00	Us.Army Retractor, 22 cm
41	2	K 432.01	Volkman Retractor, Sharp, 9x13 mm, 22 cm
42	2	K 433.01	Volkman Retractor, Blunt, 8x13 mm. 22 cm
43	2	K 481.00	Greene Retractor, 28 x 20 mm 22.5 cm
44	1	Y 390.03	Wire Basket, 255x245x30 mm
45	1	Y 190.07	Wire Basket, 485x255x70 mm
46	1	Y 110.13	1/1 Size Container, 580x280x135 mm

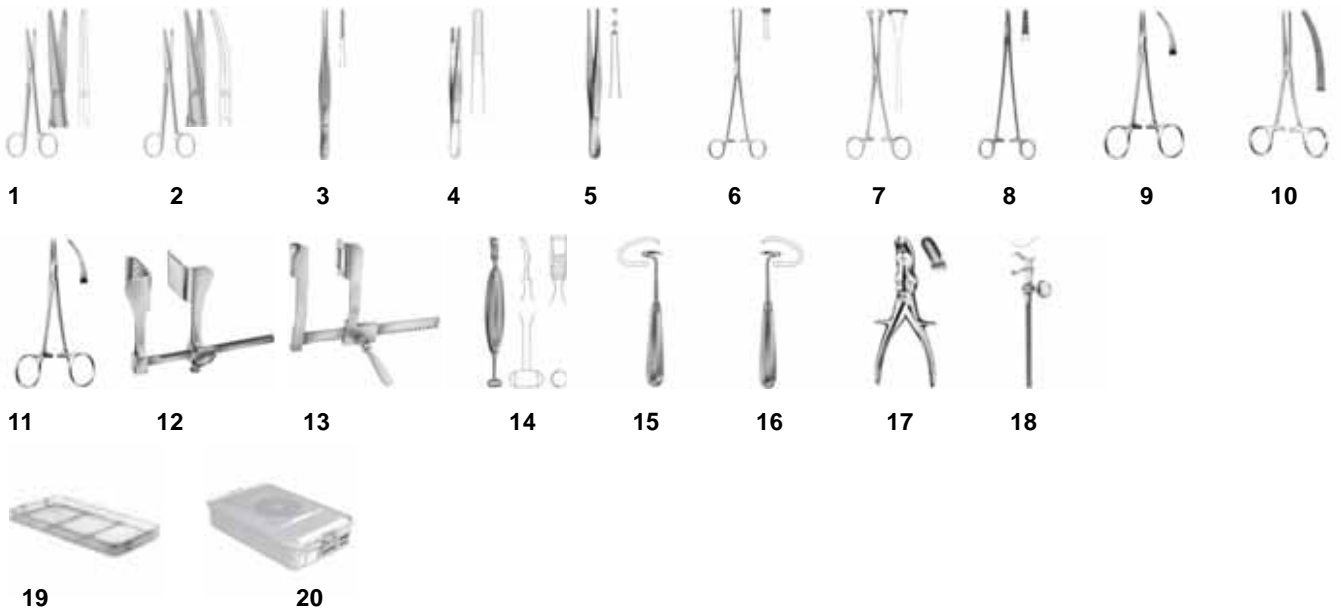

No	Quantity	Code	Description
1	1	C 458.01	Mayo Surgical Scissors, Straight, 20 cm
2	1	C 459.01	Mayo Surgical Scissors, Curved, 20 cm
3	1	D 220.02	Cushing Dissecting Forcep, Straight, 25 cm
4	1	D 240.05	Standart Dissecting Forcep, 20 cm
5	1	D 360.06	Standart Tissue Forcep, 20 cm
6	6	E 147.01	Allis Tissue Grasping Forcep, 5x6 teeth, 19 cm
7	2	E 171.02	Babcock Tissue Grasping Forcep, 22 cm
8	2	F 357.01	Hegar Needle Holder, HM, 24.5 cm
9	18	G 207.00	Micro-Halsted Delicate Haemostatic Forcep, Curved, 12.5 cm
10	12	G 431.00	Rochester-Pean Haemostatic Forcep, Curved, 16 cm
11	6	G 654.00	Mixer Ligature Forcep, Curved, 23 cm
12	2	L 804.00	Tuffier Rib Spreader 12.5x13x17 mm, Bleyd 43x53 mm
13	1	L 810.00	Finochietto Rib Spreader, 20x21x26 cm, Blade 44 x 65 mm
14	1	M 285.00	Alexander Raspatorie, 12 mm, 21 cm
15	1	M 290.01	Doyen Raspatorie, 17.5 cm
16	1	M 291.01	Doyen Raspatorie, 17.5 cm
17	1	P 321.01	Luer-Stille Bone Rongeurs 22.5 cm
18	1	T 852.00	Bailey Rib Spreader, 20 cm
19	1	Y 290.07	Wire Basket, 405x255x70 mm
20	1	Y 210.10	3/4 Size Container, 465x280x100 mm

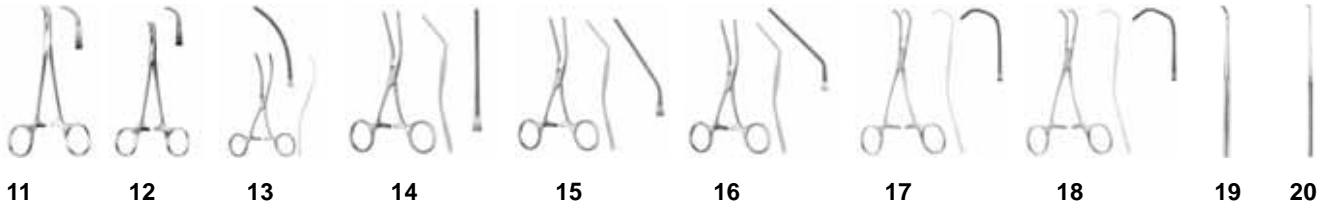
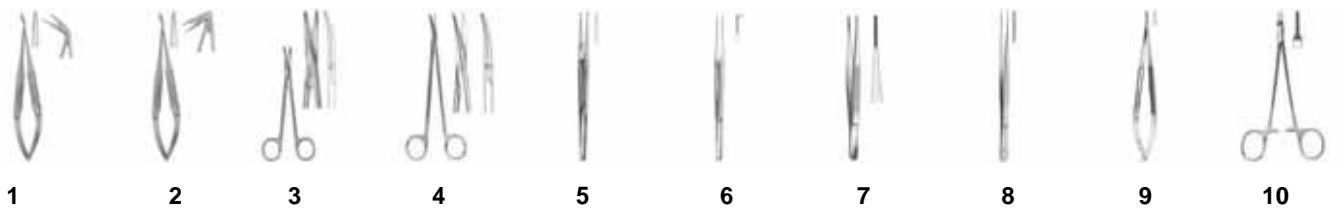

No	Quantity	Code	Description
1	1	C 134.03	Vascular Scissors 60° 18.5 cm
2	1	C 134.06	Vascular Scissors 125° 18.5 cm
3	1	C 756.00	Metzenbaum Dissecting Scissors 14.5 cm
4	1	C 758.00	Toennis-Adson Dissecting Scissors 17.5 cm
5	1	D 162.21	Forcep Ø1.3x2.0 mm 18 cm
6	1	D 257.01	De Bakey Forcep 1 mm 18 cm
7	1	D 265.01	De Bakey Forcep 1.5 mm 20 cm
8	1	D 267.00	De Bakey Forcep 1 mm 15 cm
9	1	F 156.23	Micro Needle Holder With catch 0.8x11 mm 20.5 cm
10	1	F 380.01	Ryder Needle Holder H.M. 15.5 cm
11	1	G 614.00	Micro Adson Dissecting Forcep 14 cm
12	1	G 617.00	Baby-Adson Dissecting Forcep 14 cm
13	1	H 522.00	De Bakey Bulldog Clamp 53 mm 12.5 cm
14	2	H 530.00	Castaneda Anastomosis Clamp 48 mm 12.5 cm
15	1	H 531.00	Castaneda Anastomosis Clamp 48 mm 30° 12 cm
16	1	H 532.00	Castaneda Anastomosis Clamp 48 mm 45° 12 cm
17	1	H 540.00	Castaneda Multi Purpose Clamp 15x48 mm 15.5 cm
18	2	H 540.01	Castaneda Multi Purpose Clamp 18x52 mm 15.5 cm
19	1	K 109.00	Zenker Vessel Hook 3x10 mm 18.5cm
20	1	K 135.00	Pbi Vessel Hook 90° 19 cm
21	1	K 141.00	Pbi Vessel Hook 90° 19 cm
22	1	K 152.00	Vessel Hook 8x12 mm 17.5 cm
23	1	K 153.00	Vessel Hook 12x5 mm 17.5 cm
24	1	L 881.00	Castaneda Aluminium Rib Spreader 6.5 cm
25	1	L 881.01	Castaneda Aluminium Rib Spreader 7 cm
26	1	L 881.04	Castaneda Aluminium Rib Spreader 12 cm
27	1	R 861.01	Cooley Aortic Dilator Blade opening 8-15 mm
28	1	Y 390.03	Wire Basket, 255x245x30 mm
29	1	Y 290.05	Wire Basket, 405x255x50 mm
30	1	Y 210.10	3/4 Size Container, 465x280x100 mm

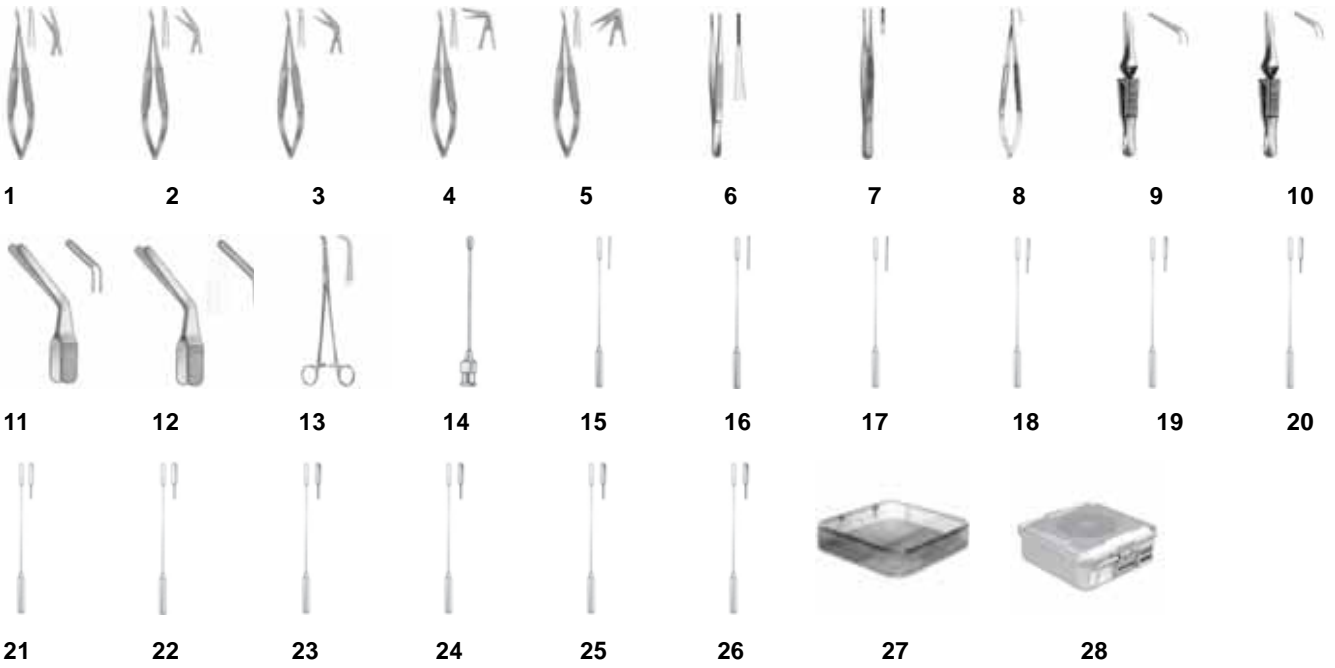

No	Quantity	Code	Description
1	1	C 135.00	Vascular Scissors 25° 18.5 cm
2	1	C 135.01	Vascular Scissors 45° 18.5 cm
3	1	C 135.03	Vascular Scissors 60° 18.5 cm
4	1	C 135.04	Vascular Scissors 90° 18.5 cm
5	1	C 135.06	Vascular Scissors 125° 18.5 cm
6	1	D 265.01	De Bakey Forcep 1.5 mm 20 cm
7	1	D 524.01	Chitwood-De Bakey Tissue Forcep 1.5 mm 19.5 cm
8	1	F 156.12	Micro Needle Holder 0.4x11 mm 18 cm
9	2	G 011.01	Diethrich Bulldog Clemp 4.5 cm
10	2	G 011.02	Diethrich Bulldog Clemp 4 cm
11	2	G 038.00	Featherlight Bulldog Clamp 10 mm 3 cm
12	2	G 038.01	Featherlight Bulldog Clamp 14 mm 3.3 cm
13	1	G 642.00	Mini-Gemini Dissecting Forcep 18 cm
14	3	J 307.01	Heparin Cannulae Ø 3 mm 4.5 cm
15	1	J 513.00	De Bakey Dilator Ø 0.5 mm 14 cm
16	1	J 513.01	De Bakey Dilator Ø 1 mm 14 cm
17	1	J 513.02	De Bakey Dilator Ø 1.5 mm 14 cm
18	1	J 513.03	De Bakey Dilator Ø 2 mm 14 cm
19	1	J 513.04	De Bakey Dilator Ø 2.5 mm 14 cm
20	1	J 513.05	De Bakey Dilator Ø 3 mm 14 cm
21	1	J 513.06	De Bakey Dilator Ø 3.5 mm 14 cm
22	1	J 513.07	De Bakey Dilator Ø 4 mm 14 cm
23	1	J 513.08	De Bakey Dilator Ø 4.5 mm 14 cm
24	1	J 513.09	De Bakey Dilator Ø 5 mm 14 cm
25	1	J 513.11	De Bakey Dilator Ø 7 mm 14 cm
26	1	J 513.13	De Bakey Dilator Ø 9 mm 14 cm
27	1	Y 390.05	Wire Basket, 255x245x50 mm
28	1	Y 310.10	1/2 Size Container, 285x280x100 mm

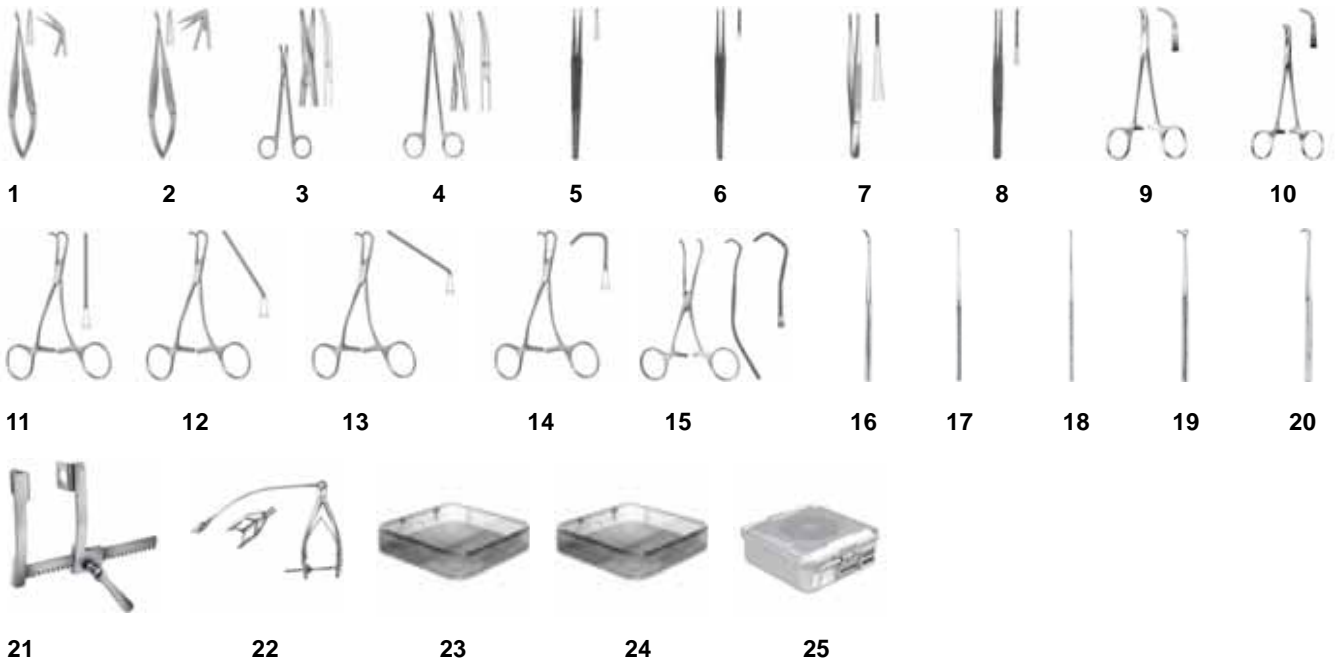

No	Quantity	Code	Description
1	1	C 134.03	Vascular Scissors 60° 18.5 cm
2	1	C 134.06	Vascular Scissors 125° 18.5 cm
3	1	C 756.00	Metzenbaum Dissecting Scissors Curved 14.5 cm
4	1	C 758.00	Toennis-Adson Dissecting Scissors Curved 17.5 cm
5	1	D 171.02T	Titanium Forcep 1.3x2.0 mm 18 cm
6	1	D 260.02T	Titanium Forcep 1.0 mm 18 cm
7	1	D 265.01	De Bakey Forcep 1.5 mm 20 cm
8	1	D 267.01T	Titanium Forcep 1.0 mm 15 cm
9	1	G 614.00	Micro-Adson Dissecting Forcep 14 cm
10	1	G 617.00	Baby-Adson Dissecting Forcep 14 cm
11	1	H 603.00	Neonatal and Pediatric Clamp 14 cm
12	1	H 603.02	Neonatal and Pediatric Clamp 14 cm
13	1	H 603.03	Neonatal and Pediatric Clamp 13 cm
14	1	H 603.07	Neonatal and Pediatric Clamp 13 cm
15	1	H 609.00	Cooley Bulldog Clamp 12x50 mm 11.5 cm
16	1	K 109.00	Zenker Vessel Hook 3x10 mm 18.5cm
17	1	K 135.00	Pbi Vessel Hook 90° 19 cm
18	1	K 141.00	Pbi Vessel Hook 90° 19 cm
19	1	K 152.00	Vessel Hook 8x12 mm 17.5 cm
20	1	K 153.00	Vessel Hook 12x5 mm 17.5 cm
21	1	L 807.00	Rib Spreader 12x14x18 cm
22	1	R 861.01	Cooley Aortic Dilator Blade opening 8-15 mm
23	1	Y 390.03	Wire Basket, 255x245x30 mm
24	1	Y 390.05	Wire Basket, 255x245x50 mm
25	1	Y 310.10	1/2 Size Container, 285x280x100 mm



1



2



3



4



5



6



7



8



9



10



11



12



13

No	Quantity	Code	Description
1	1	B 030.02	Scalpel Handle No 3 21.5 cm
2	1	D 265.02	De Bakey Forcep 1.5 mm 24 cm
3	1	D 390.02	Russ Modell Tissue Forcep 25 cm
4	1	F 347.01	Needle Holder 20 cm
5	1	F 355.00	Hegar-Mayo Needle Holder 15 cm
6	12	G 214.00	Halsted-Mosquito Delicate Haemostatic Forceps Straight 12.5 cm
7	1	H 568.00	De Bakey-Harken Vena Cava Clamp 86 mm 24.5 cm
8	1	K 695.01	Cooley Retractor Slightly Serrated 45x35 mm 26.5 cm
9	1	K 695.02	Cooley Retractor Slightly Serrated 45x48 mm 26.5 cm
10	1	K 697.02	Cooley Retractor Left 25x46 mm 28 cm
11	1	L 865.00	Minimally Invasive Surgery Systems Complete
12	1	Y 290.05	Wire Basket, 405x255x50 mm
13	1	Y 210.10	3/4 Size Container, 465x280x100 mm

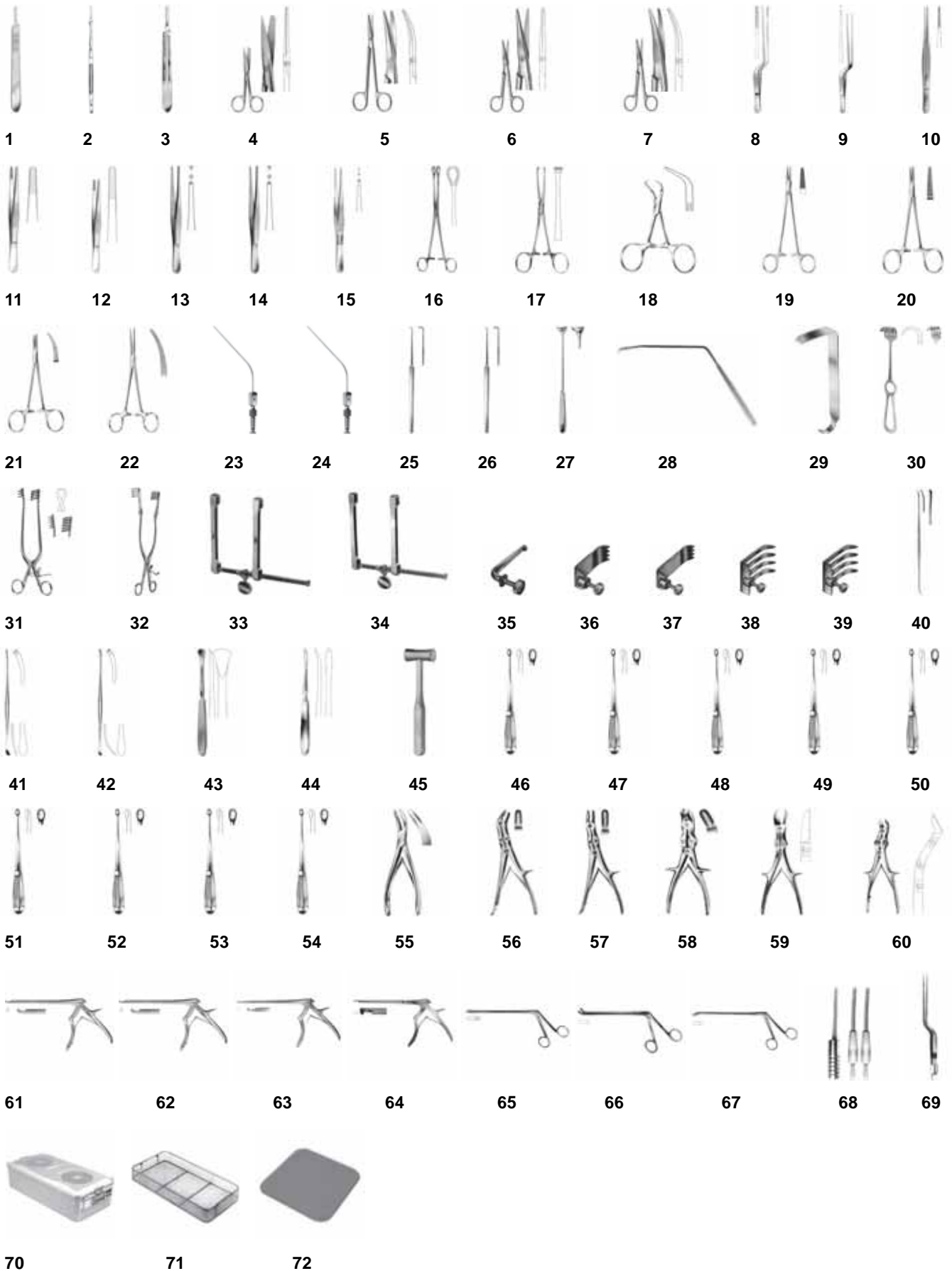

No	Qty	Code	Description	No	Qty	Code	Description
1	1	B 030.01	Scalpel Handle 3no 13.5cm				
2	1	B 032.00	Scalpel Handle 3no 16.5cm				
3	1	B 040.01	Scalpel Handle 4no 13.5cm				
4	1	C 310.03	Scýssors Straýgt 14.5cm				
5	1	C 421.01	Metzenbaum Scýs. Curved 18cm				
6	1	C 442.01	Mayo-Stille Scýs Straight 17cm				
7	1	C 443.01	Mayo-Stille Scýs Curved 17cm				
8	1	D 149.00	Gruenwald Bayonet Forc. 20cm				
9	1	D 154.00	Bayonet Forc. Teeth 20cm				
10	2	D 220.00	Cushýng Dýssec. Forc. Straýg. 18cm				
11	2	D 240.02	Standard Dýssec. Forc. Straýg. 14.5cm				
12	1	D 240.05	Standard Dýssec. Forc. Straýg. 20cm				
13	2	D 360.03	Standard Týssue Forc. Straýg. Teeth 14.5cm				
14	1	D 360.06	Standard Týssue Forc. Straýg. Teeth 20cm				
15	1	D 361.01	Týssue Forc. Straýg. Teeth 13cm				
16	6	E 086.00	Foerster-Ballenger Dres. Forc. Straýg. 24cm				
17	6	E 144.00	Allýs Grasping Forc. 5 x 6 Teeth 15.5cm				
18	18	E 430.01	Backhaus Towel Clamps 11cm				
19	2	F 355.00	Hegar-Mayo H. Metal Needle Holder Forc. 15cm				
20	18	G 214.00	Halsted-Mosqoyto Haemos. Forc. Straýg. 12.5cm				
21	18	G 215.00	Halsted-Mosqoyto Haemos. Forc. Curv. 12.5cm				
22	12	G 265.00	Cryle Haemos. Forc. Curv. 16cm				
23	2	J 214.02	Fergusson Suction Tubes Ø 3.0 mm 18cm				
24	1	J 214.03	Fergusson Suction Tubes Ø 4.0 mm 18cm				
25	1	K 104.00	Cushýng Hooks 19cm				
26	1	K 104.01	Cushýng Hooks 19cm				
27	2	K 274.00	Cushýng Retractor 11x14mm 25cm				
28	1	K 278.01	Scovýle Nerve Retrac. 8mm 21cm				
29	1	K 335.01	Hýbbs Retrac. 51x20mm 23.5cm				
30	2	K 436.02	Kocher Retrac. 15.5x20mm 22cm				
31	2	L 353.02	Weylaner Self-Retaýnýng Retrac. Sharp 24cm				
32	2	L 379.01	Self-Retaýnýng Retrac. Sharp 29cm				
33	1	L 455.00	Scovýle Haverfýeld Self-Retaýnýng Retrac.				
34	1	L 455.01	Scovýle Self-Retaýnýng Retrac.				
35	2	L 455.14	Scovýle Blade 50mm				
36	2	L 455.18	Scovýle Blade 65x25mm				
37	1	L 455.20	Scovýle Blade 85x25mm				
38	1	L 455.22	Scovýle Blade 41x38mm				
39	1	L 455.24	Scovýle Blade 67x44mm				
40	2	M 115.01	Davýs Dýssector 24.5cm				
41	1	M 175.01	Penfýeld Dissec. 19.5cm				
42	1	M 175.02	Penfýeld Dissec. 19.5cm				
43	2	M 265.01	Langenbeck Raspa 16mm 19cm				
44	2	M 340.01	Qervayn Bone Lever 6mm 19.5cm				
45	1	M 818.02	Bergmann Mallets 300gr. 23.5cm				
46	1	N 202.01	Hýbbs-Spratt Bone Curet 1.8mm 20cm				
47	1	N 202.02	Hýbbs-Spratt Bone Curet 2.2mm 20cm				
48	1	N 202.03	Hýbbs-Spratt Bone Curet 3.5mm 20cm				
49	1	N 202.04	Hýbbs-Spratt Bone Curet 4.0mm 20cm				
50	1	N 202.05	Hýbbs-Spratt Bone Curet 4.5mm 20cm				
51	1	N 202.06	Hýbbs-Spratt Bone Curet 5.5mm 20cm				
52	1	N 202.07	Hýbbs-Spratt Bone Curet 7.2mm 20cm				
53	1	N 202.08	Hýbbs-Spratt Bone Curet 8.5mm 20cm				
54	1	N 202.09	Hýbbs-Spratt Bone Curet 10.5mm 20cm				
55	1	P 278.00	Jansen Bone Rong. 17.5cm				
56	1	P 315.01	Stýle Bone Rong. 23.5cm				
57	1	P 316.01	Leksell-Stille Bone Rong. 24cm				
58	1	P 321.01	Luer-Stille Bone Rong. 22.5cm				
59	1	P 376.01	Lýston Bone Cuttýng Forc. 28cm				
60	1	P 379.01	Lýston-Horsley Bone Cutt. Forc. 25.5cm				
				61	1	P 430.02	Kerrýson Punc. 3mm 18cm
				62	1	P 430.04	Kerrýson Punc. 5mm 18cm
				63	1	P 431.04	Kerrýson Punc. 5mm 18cm
				64	1	P 433.04	Kerrýson Punc. 5mm 18cm
				65	1	R 383.01	Gruenwald Rong. Stra. 3x10mm 18cm
				66	1	R 384.01	Gruenwald Rong. Curv. 3x10mm 18cm
				67	1	R 385.01	Gruenwald Rong. Curv. 3x10mm 18cm
				68	2	Z 065.00	Bipolar Cord 2mt.
				69	2	Z 180.01	Electro forc. non-ýnsul. 1.0mm 18.5cm
				70	1	Y 110.15	1/1 Sýze Cont. 580x280x150mm
				71	2	Y 190.05	Wýre Basket 485x255x50mm
				72	1	Y 851.00	Slicon Mat 245x245 mm

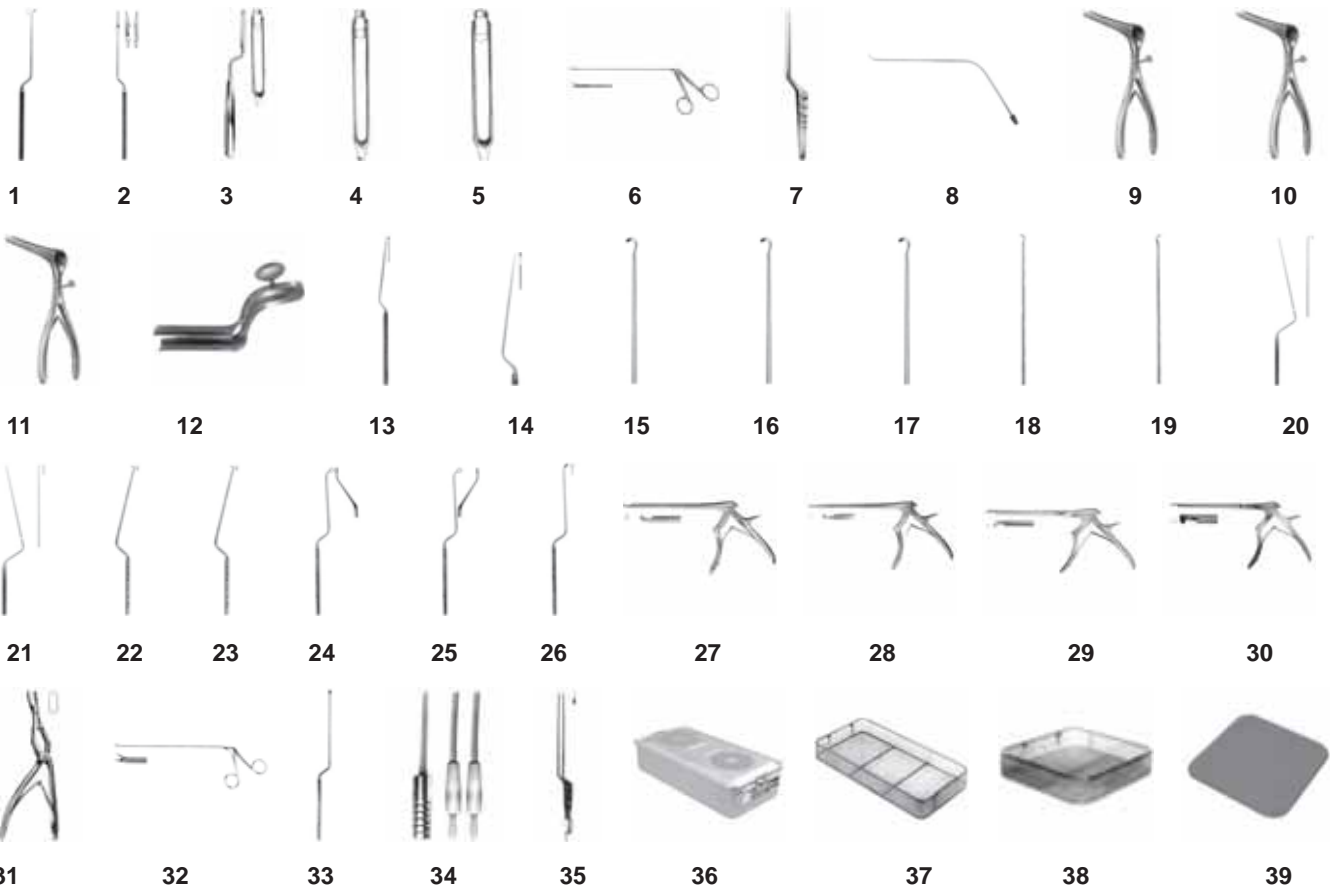

No	Quantity	Code	Description
1	1	A 320.01	Micro Mýrrol 24cm
2	1	B 020.00	Scalpel Handle 21 cm
3	1	B 480.03	Ballanger Knife 6x5 mm Curv. 21cm
4	1	B 481.01	Ballanger Knife 4x3 mm Stra. 21cm
5	1	B 481.02	Ballanger Knife 5x4 mm Stra. 21cm
6	1	C 138.00	Sweet Micro Scis. Stra. 14cm
7	2	D 168.01	Yasargyl Bayonet Forc. 0.9mm 22cm
8	2	J 262.02	Landolt Suctýon Tubes Ø3mm 15cm
9	1	L 275.00	Cottle Nasal Speculum 76x7mm 13.5cm
10	1	L 275.01	Cottle Nasal Speculum 90x7mm 13.5cm
11	1	L 275.02	Cottle Nasal Speculum 100x7mm 13.5cm
12	1	L 295.00	Cushýng Landolt Spekulum 70x15mm
13	1	M 133.00	Mýcro Dýssector Curv 23cm
14	1	M 134.00	Mýcro Dýssector Curv. 23cm
15	1	M 140.01	Hardy Dýssector Rýght Sharp 24.5cm
16	1	M 141.01	Hardy Dýssector Rýght Sharp 24.5cm
17	1	M 142.01	Hardy Dýssector Left Kúnt 24.5cm
18	1	M 144.00	Hardy Dýssector Sharp 24.5cm
19	1	M 144.01	Hardy Dýssector Sharp 24.5cm
20	1	N 108.00	Fahlbush Malleable Curet. Ø2.5mm 26cm
21	1	N 109.00	Landolt Rulent Curet. Ø2.5mm 26cm
22	1	N 113.00	Hardy Malleaple Curet Ø4mm 26cm
23	1	N 113.02	Hardy Malleaple Curet Ø6mm 26cm
24	1	N 115.01	Nýcola Malleaple Curet Left Ø6.5mm 21.5cm
25	1	N 116.01	Nýcola Malleaple Curet Rýght Ø6.5mm 21.5cm
26	1	N 117.01	Nýcola Malleaple Curet Rýght Ø6.5mm 21.5cm
27	1	P 430.01	Kerrýson Punches 2mm 18cm
28	1	P 431.01	Kerrýson Punches 1mm 18cm
29	1	P 432.01	Kerrýson Punches 1mm 18cm
30	1	P 433.01	Kerrýson Punches 2mm 18cm
31	1	P 580.00	Jansen Mýddleton Forc. 20cm
32	1	C 098.00	Landolt Mýcro Scissors 16.5cm
33	1	T 085.00	Hardy Implantfork 24.5cm
34	2	Z 065.00	Bipolar Cord 2mt.
35	2	Z 200.10	Elektro Forcep Insulated 1.0mm 22cm
36	1	Y 110.13	1/1 Sýze Cont. 580x280x135mm
37	1	Y 190.05	Wýre Baskets 485x255x70mm
38	1	Y 390.05	Wýre Baskets 255x245x50
39	2	Y 851.00	Slicon Mat 245x245 mm

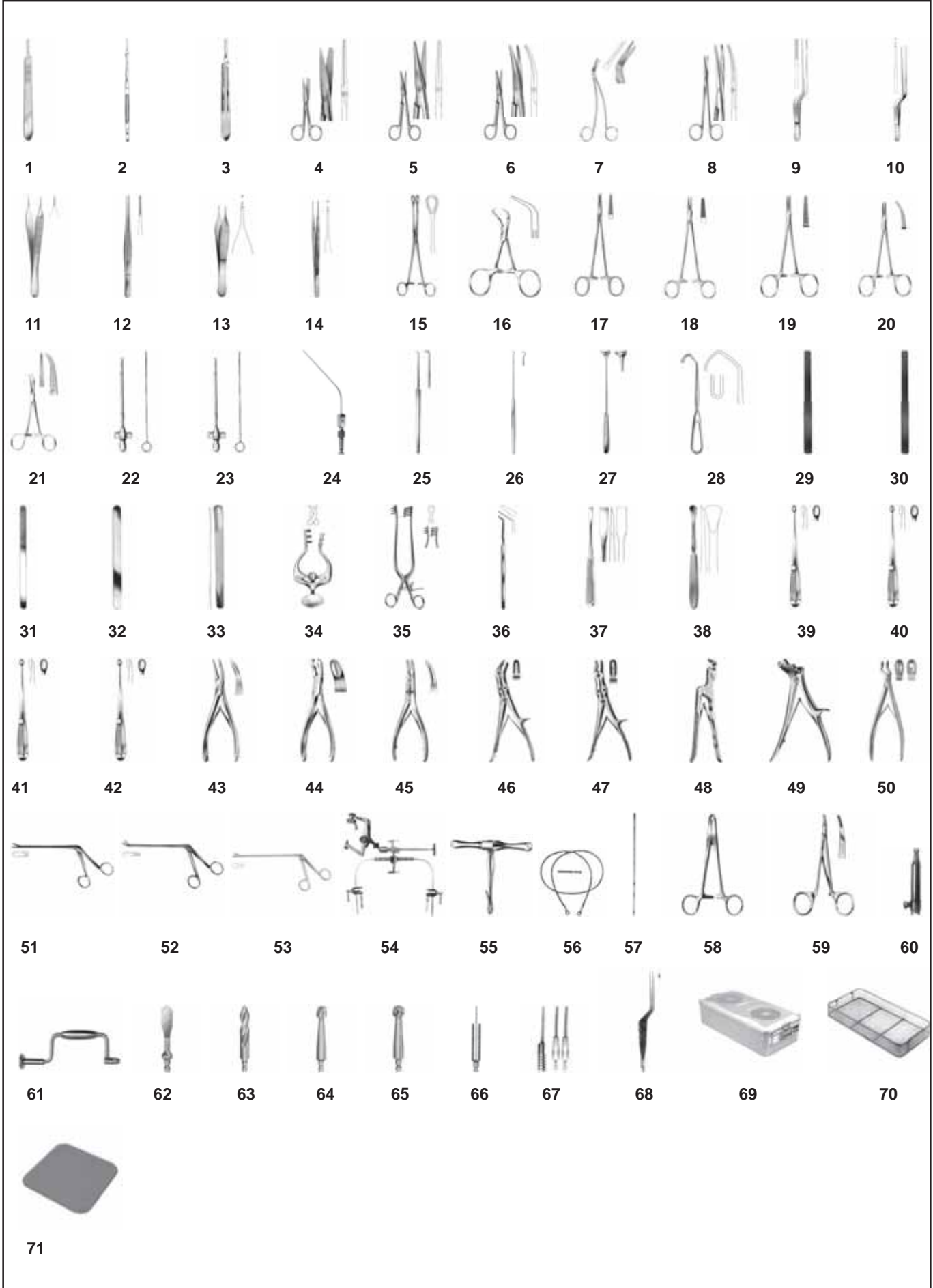

No	Qty	Code	Description	No	Qty	Code	Description
1	1	B 030.01	Scalpel Handle 3no 13.5cm	61	1	V 500.02	Perforators Brace Only
2	1	B 032.00	Scalpel Handle 3no 16.5cm	62	1	V 500.03	Cushýng Drill Ø14mm
3	1	B 040.01	Scalpel Handle 4no 13.5cm	63	1	V 500.04	Mc Kenzýe Drill Ø13mm
4	1	C 310.03	Scýssors Stra. 14.5cm	64	1	V 500.05	Hudson Drill Ø14mm
5	1	C 442.01	Metzenbaum Scýs. Curv. 18cm	65	1	V 500.06	Hudson Drill Ø16mm
6	1	C 443.01	Mayo-Stille Scýs Stra. 17cm	66	1	V 500.07	Drill Ø2mm
7	1	C 520.00	Shmyeden Taylor Scýs. 15.5cm	67	2	Z 065.00	Bipolar Cord 2mm
8	1	C 753.00	Baby Metzenbaum Scis. Curv. 14.5cm	68	2	Z 160.15	Electro Forc. Insulated 1.3mm 19.5cm
9	1	D 149.00	Gruenvald Bayonet Forc. 20cm	69	1	Y 110.15	1/1 Sýze Cont. 580x280x150mm
10	1	D 154.00	Bayonet Forc. Teeth 20cm	70	2	Y 190.05	Wýre Baskets 485x255x50mm
11	2	D 204.00	Mýcro Adson Forc. 12cm	71	1	Y 851.00	Slicon Mat 245x245mm
12	2	D 220.00	Cushýng Dýssec. Forc. Stra. 18cm				
13	2	D 323.00	Adson Forc. Teeth 12cm				
14	2	D 365.00	Gerald Forc. Teeth 17.5cm				
15	6	E 086.00	Ballanger Dres Forc. Stra. 24cm				
16	12	E 430.01	Backhaus Towel Clamps 11cm				
17	2	F 346.00	De Bakey Needle Holders 18 cm				
18	2	F 355.00	Mayo Hard Me. Need. Hol. 15cm				
19	18	G 214.00	Mosqoýto Haem. Forc. Stra. 12.5cm				
20	18	G 215.00	Mosqoýto Haem. Forc. Cur. 12.5cm				
21	24	G 238.00	Dandy Haem. Forc. Curv. 14cm				
22	1	J 200.00	Suctýon Tubes Ø2mm 7cm				
23	1	J 200.01	Suctýon Tubes Ø2.5mm 7cm				
24	2	J 214.01	Fergusson Suct. Tubes Ø2.0mm 18cm				
25	2	K 104.00	Cushýng Hooks 19cm				
26	2	K 138.00	Gýlýes Hooks 18cm				
27	2	K 274.00	Cushýng Retracs. 11x14mm 25cm				
28	2	K 279.00	Cushýng Retracs. 20cm				
29	1	K 560.03	Braýn Spatulas Malle. 13+14mm 20cm				
30	1	K 560.04	Braýn Spatulas Malle. 16+17mm 20cm				
31	1	K 561.02	Braýn Spatulas Malle. 12mm 25cm				
32	2	K 562.02	Braýn Spatulas Malle. 17mm 25cm				
33	1	K 564.03	Braýn Spatulas Malle. 15+18mm 18cm				
34	2	L 093.00	Jansen Retracs. 10cm				
35	2	L 353.01	Weylaner Retracs. Sharp 19.5cm				
36	2	M 182.00	Frazýer Raspa 15cm				
37	1	M 240.01	Adson Raspa 8mm 17cm				
38	1	M 265.01	Langenbeck Raspa 16mm 19cm				
39	1	N 202.01	Hýbs-Spr. Bone Curet. 1.8mm 20cm				
40	1	N 202.04	Hýbs-Spr. Bone Curet. 4.0mm 20cm				
41	1	N 202.05	Hýbs-Spr. Bone Curet. 4.5mm 20cm				
42	1	N 202.06	Hýbs-Spr. Bone Curet. 5.5mm 20cm				
43	1	P 285.00	Beyer Bone Rong. 18cm				
44	1	P 291.00	Luer Bone Rong. 17.5cm				
45	1	P 303.00	Zufal-Jansen Bone Rong. 18cm				
46	1	P 315.01	Stýlle Bone Rong. 23.5cm				
47	1	P 316.01	Leksell-Stille Bone Rong. 23.5cm				
48	1	P 560.01	Sweet Bone Punc. 21cm				
49	1	P 564.00	De Vjýbýs Bone Punc.(Wýth1Hook)20cm				
50	1	P 572.00	Dura Protectors 20.5cm				
51	1	R 375.02	Caspar Rong. Stra. 4mm 15.5cm				
52	1	R 377.02	Caspar Rong. Curv. 4mm 15.5cm				
53	1	R 410.00	Oldberg Rong. Ø7mm 18cm				
54	1	S 541.00	Set For Fixýng Skull Clamp Set				
55	2	T 530.00	Gigli Wire Saws Handle				
56	10	T 536.00	Gigli Wire Saws 2 Wire 30cm				
57	2	T 540.00	De Martel Guide 35cm				
58	1	T 550.00	Raney Applying Forc. 16cm				
59	1	T 555.00	Mc Kenzýe Applying Forc. 15cm				
60	1	V 500.01	Perforators Brace Only				

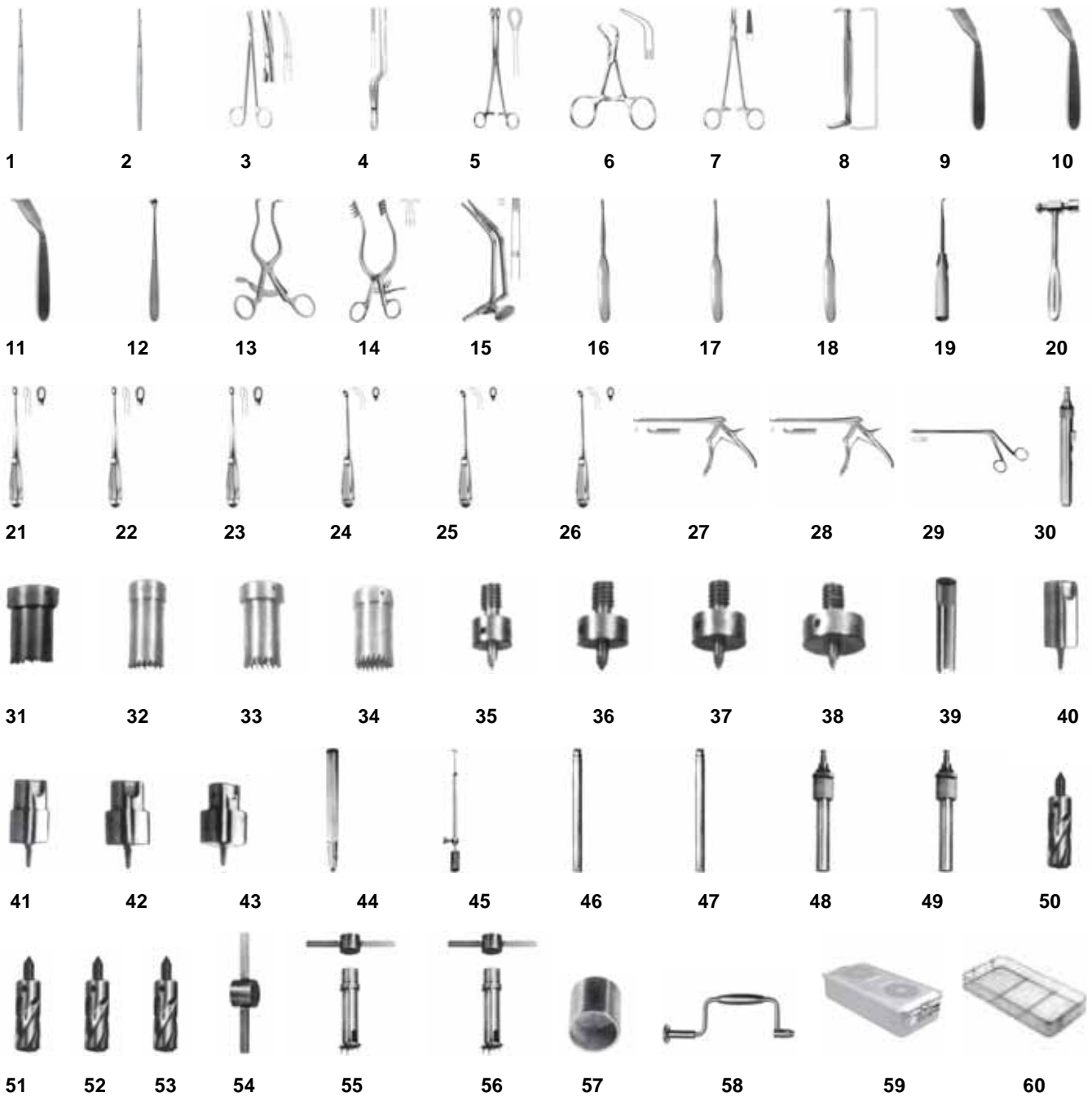

No	Quantity	Code	Description
1	1	B 030.01	Scalpel Handle 3no 13.5cm
2	1	B 034.00	Scalpel Handle 3no 22.5cm
3	1	C 416.00	Toennys Adson Scis. Curv. 17.5cm
4	1	D 149.00	Gruenwald Bayonet Forc. 20cm
5	4	E 086.00	Foerster-Ballanger Dres Forc. Stra. 24cm
6	12	E 430.01	Backhaus Towel Clamps 11cm
7	2	F 355.00	Mayo Hegar Needle Holders
8	1	K 342.00	Us Army Retrac. 22cm
9	1	K 552.00	Cloward Retrac. 18mm 18cm
10	1	K 552.01	Cloward Retrac. 20mm 18cm
11	1	K 552.02	Cloward Retrac. 23mm 18cm
12	1	K 555.00	Cloward Retrac. 10x8mm 19cm
13	1	L 311.00	Retrac. Blunt 13cm
14	2	L 356.00	Anderson-Adson Retrac. Sharp 19cm
15	1	L 495.00	Cloward Lamina Spreaders 4.5mm 13.5cm
16	1	M 567.00	Cloward Elevator 5mm 20cm
17	1	M 567.01	Cloward Elevator 8mm 20cm
18	1	M 567.02	Cloward Elevator 10mm 20cm
19	1	M 568.00	Cloward Elevator 20cm
20	1	M 814.01	Cloward Mallets 230gr. 19cm
21	1	N 202.01	Hjbs-Spratt Bone Curet. 1.8mm 20cm
22	1	N 202.02	Hjbs-Spratt Bone Curet. 2.2mm 20cm
23	1	N 202.03	Hjbs-Spratt Bone Curet. 3.5mm 20cm
24	1	N 203.01	Hjbs-Spratt Bone Curet. 1.8mm 20cm
25	1	N 203.02	Hjbs-Spratt Bone Curet. 2.2mm 20cm
26	1	N 203.03	Hjbs-Spratt Bone Curet. 3.5mm 20cm
27	1	P 430.02	Kerryson Punc. 3mm 18cm
28	1	P 430.03	Kerryson Punc. 4mm 18cm
29	1	R 386.02	Spurling Rong. Stra. 2x10mm 18cm
30	1	T 470.00	Cloward Dowel Cutter Shaft 16.5cm
31	1	T 471.00	Cloward Dowel Cutter Ø12mm
32	1	T 471.01	Cloward Dowel Cutter Ø14mm
33	1	T 471.02	Cloward Dowel Cutter Ø16mm
34	1	T 471.03	Cloward Dowel Cutter Ø18mm
35	1	T 472.00	Cloward Dowel Center Pins Ø12mm
36	1	T 472.01	Cloward Dowel Center Pins Ø14mm
37	1	T 472.02	Cloward Dowel Center Pins Ø16mm
38	1	T 472.03	Cloward Dowel Center Pins Ø18mm
39	1	T 475.00	Cloward Dowel Ejector
40	1	T 477.00	Cloward Dowel Holders Ø12mm
41	1	T 477.01	Cloward Dowel Holders Ø14mm
42	1	T 477.02	Cloward Dowel Holders Ø16mm
43	1	T 477.03	Cloward Dowel Holders Ø18mm
44	1	T 478.00	Cloward Dowel Handle
45	1	T 480.01	Cloward Depth Gauge 21cm
46	1	T 482.00	Cloward Guard Guide Ø9.5mm 19cm
47	1	T 482.01	Cloward Guard Guide Ø13 mm 19cm
48	1	T 483.00	Cloward Drill Shaft Small Ø13mm 14cm
49	1	T 483.01	Cloward Drill Shaft Large Ø16mm 14cm
50	1	T 484.00	Cloward Drill Tip Ø10mm
51	1	T 484.01	Cloward Drill Tip Ø12mm
52	1	T 484.02	Cloward Drill Tip Ø14mm
53	1	T 484.03	Cloward Drill Tip Ø16mm
54	1	T 486.00	Cloward Handle Ø22mm
55	1	T 487.00	Cloward Drill Guard Small Ø13mm
56	1	T 487.01	Cloward Drill Guard Large Ø16mm
57	1	T 488.00	Cloward Drill Guard Çap Ø25mm 3cm
58	1	V 500.02	Hudson Brace Only
59	1	Y 110.13	1/1 SýzeCont. 580x280x135mm
60	1	Y 190.07	Wýre Baskets 485x255x70mm

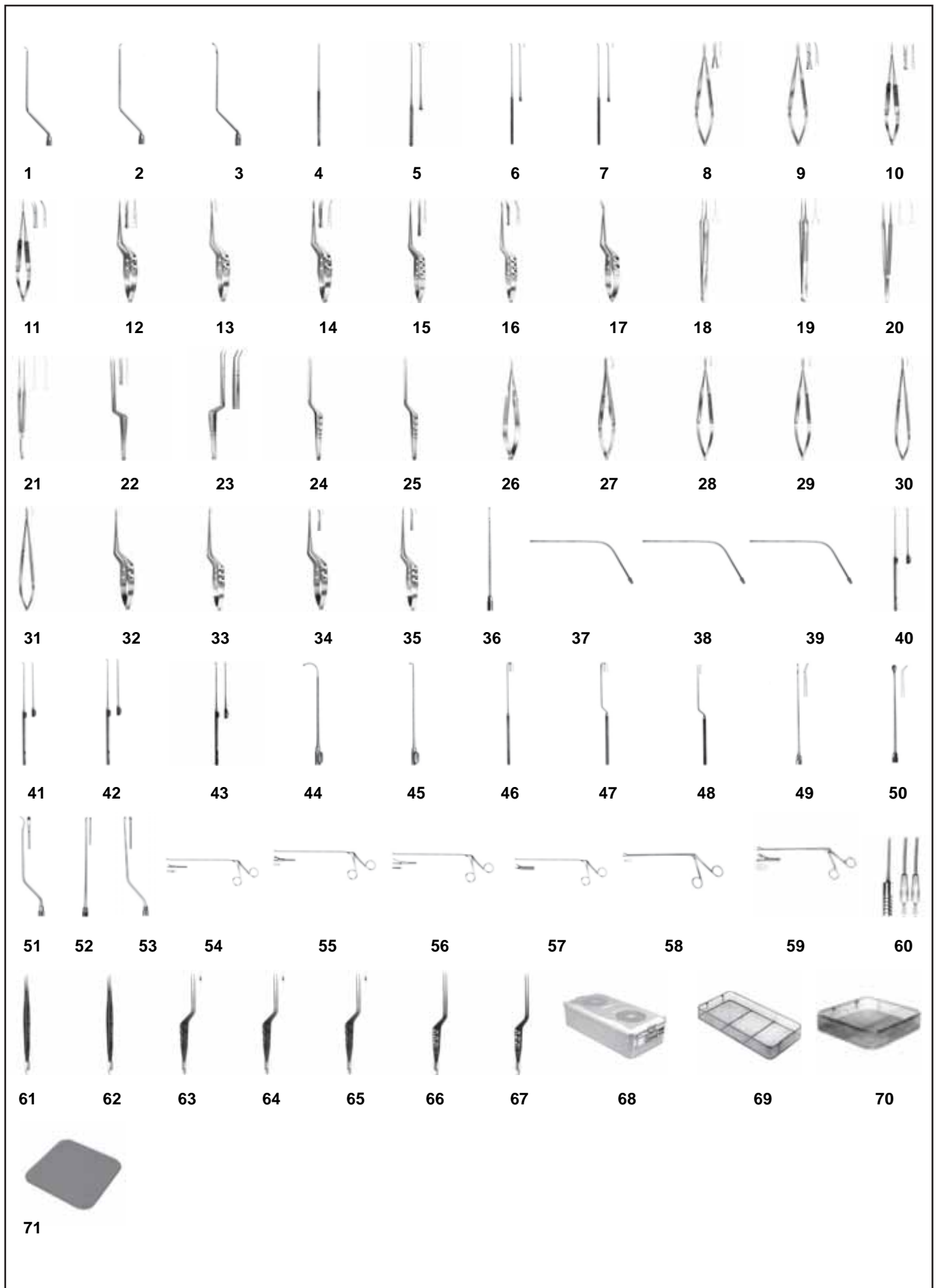

No	Qty	Code	Description
1	1	B 060.00	Mýcro Vessel Knives Curv. 18.5cm
2	1	B 060.01	Mýcro Vessel Knives Curv. 18.5cm
3	1	B 062.01	Koos Mýcro Vessel Knives Curv. 18.5cm
4	1	B 064.00	Jacopson Mýcro Vessel Knives Stra. 18.5cm
5	1	B 065.16	SamýýKniv. for tum. tissue Stra. 4.0mm 23cm
6	1	B 067.01	SamýýKnives for tumor tissue 1.8mm 23cm
7	1	B 067.02	SamýýKnives for tumor tissue 2.5mm 23cm
8	1	C 112.00	Mýcro Scýs. Straýg. 16cm
9	1	C 113.00	Mýcro Scýs. Curved 16cm
10	1	C 124.00	Yasargý Mýcro Scýs. Stra. 18.5cm
11	1	C 125.00	Jacobson Mýcro Scýs. Curv. 18.5cm
12	1	C 176.00	Yasargý Mýcro Scýs. Stra. 20cm
13	1	C 177.00	Yasargý Mýcro Scýs. Curv. 20cm
14	1	C 178.00	Yasargý Mýcro Scýs. Curv. 20cm
15	1	C 180.00	Yasargý Mýcro Scýs. Stra. 22.5cm
16	1	C 182.00	Yasargý Mýcro Scýs. Curv. 22.5cm
17	1	C 195.00	Mýcro Scýs. Curv. 20cm
18	1	D 127.00	Lazar Mýcro Suture Forc. 0.5mm 15.5cm
19	1	D 128.00	Lazar Mýcro Suture Forc. 0.8mm 15.5cm
20	1	D 130.01	Mýcro Suture Forc. 0.3mm 15cm
21	1	D 130.02	Mýcro Suture Forc. 0.6mm 18cm
22	1	D 140.01	Lýgature Forc. 18.5cm
23	1	D 141.00	Lýgature Forc. 18.5cm
24	1	D 168.00	Yasargý Bayonet Forc. 0.6mm 22cm
25	1	D 168.01	Yasargý Bayonet Forc. 9mm 22cm
26	1	F 110.00	Castro. Ne. Hol. Strh. Wýth catch 14.5cm
27	1	F 111.00	Castro Ne. Hol. Curv. Wýth catch 14.5cm
28	1	F 112.00	Needle Hol. Wýthout catch Strh. 16cm
29	1	F 113.00	Needle Hol Wýthout catch Curv. 16cm
30	1	F 118.00	Yasargý Ned. Hol. Strh. Wýth catch 20cm
31	1	F 119.00	Yasargý Ned. Hol. Curv. Wýth catch 20cm
32	1	F 170.00	Yasargý Ned. Hol. Strh. 20cm
33	1	F 170.01	Yasargý Ned. Hol. Strh. 22.5cm
34	1	F 171.00	Yasargý Ned. Hol. Curv. 20cm
35	1	F 171.01	Yasargý Ned. Hol. Curv. 22.5cm
36	1	J 076.01	Jacobson Probe Wýth Ball Tip 18.5cm
37	1	J 260.07	Yasargý Suct. Tubes Ø2.0mm 22cm
38	1	J 260.11	Yasargý Suct. Tubes Ø2.5mm 22cm
39	1	J 260.15	Yasargý Suct. Tubes Ø3.5mm 22cm
40	1	K 110.00	Krayenbühl Lessel Hooks 18.5cm
41	1	K 110.01	Krayenbühl Lessel Hooks 18.5cm
42	1	K 110.02	Krayenbühl Lessel Hooks 18.5cm
43	1	K 110.03	Krayenbühl Lessel Hooks 18.5cm
44	1	K 111.01	Yasargý Lýgature Guýde 18.5cm
45	1	K 111.03	Yasargý Lýgature Guýde 18.5cm
46	1	M 130.02	Caspar Mýc. Dýssec. Curv. 4.5mm 23cm
47	1	M 131.02	Caspar Mýc. Dýssec. Curv. 4.5mm 23cm
48	1	M 132.00	Caspar Mýc. Dýssec. Curv. 1mm 21cm
49	1	M 137.00	Yasargý Mýcro Rasp. Ang. 18.5cm
50	1	M 137.02	Yasargý Mýcro Rasp. Ang. 18.5cm
51	1	M 138.02	Yasargý Mýcro Rasp. Curv. 18.5cm
52	1	N 100.00	Mýcro Scoops Sharp 23cm
53	1	N 102.00	Yasargý Mýcro Scoops 18.5cm
54	1	C 096.00	Nicola Sciss. 16.5cm
55	1	R 202.00	Nýcola Forc. Ø2.5mm 16.5cm
56	1	R 204.00	Yasargý-Nýcola Forc. 16.5cm
57	1	C 098.00	Landolt Scissors 16.5cm
58	1	R 412.00	Yasargý Rong. Ø2.2mm 19cm
59	1	R 415.00	Landolt Forc. Ø9mm 20cm
60	4	Z 065.00	Bipolar Cord 2mt.

No	Qty	Code	Description
61	1	Z 150.00	Electro Forc. Ins. 0.6mm 16cm
62	1	Z 150.01	Electro Forc. Ins. 0.9mm 16cm
63	1	Z 160.16	Electro Forc. Ins. 0.4mm 21.5cm
64	1	Z 160.18	Electro Forc. Ins. 1.0mm 21.5cm
65	1	Z 160.19	Electro Forc. Ins. 1.3mm 21.5cm
66	1	Z 163.01	Electro Forc. Ins 0.7mm 21.5cm
67	1	Z 164.01	Electro Forc. Ins. 0.7mm 21.5cm
68	1	Y 110.15	1/1 Sýze Cont. 580x280x150mm
69	1	Y 190.05	Wire Baskets 485x255x50mm
70	1	Y 390.03	Wire Baskets 255x245x30mm
71	2	Y 851.00	Slicon Mat 245x245 mm

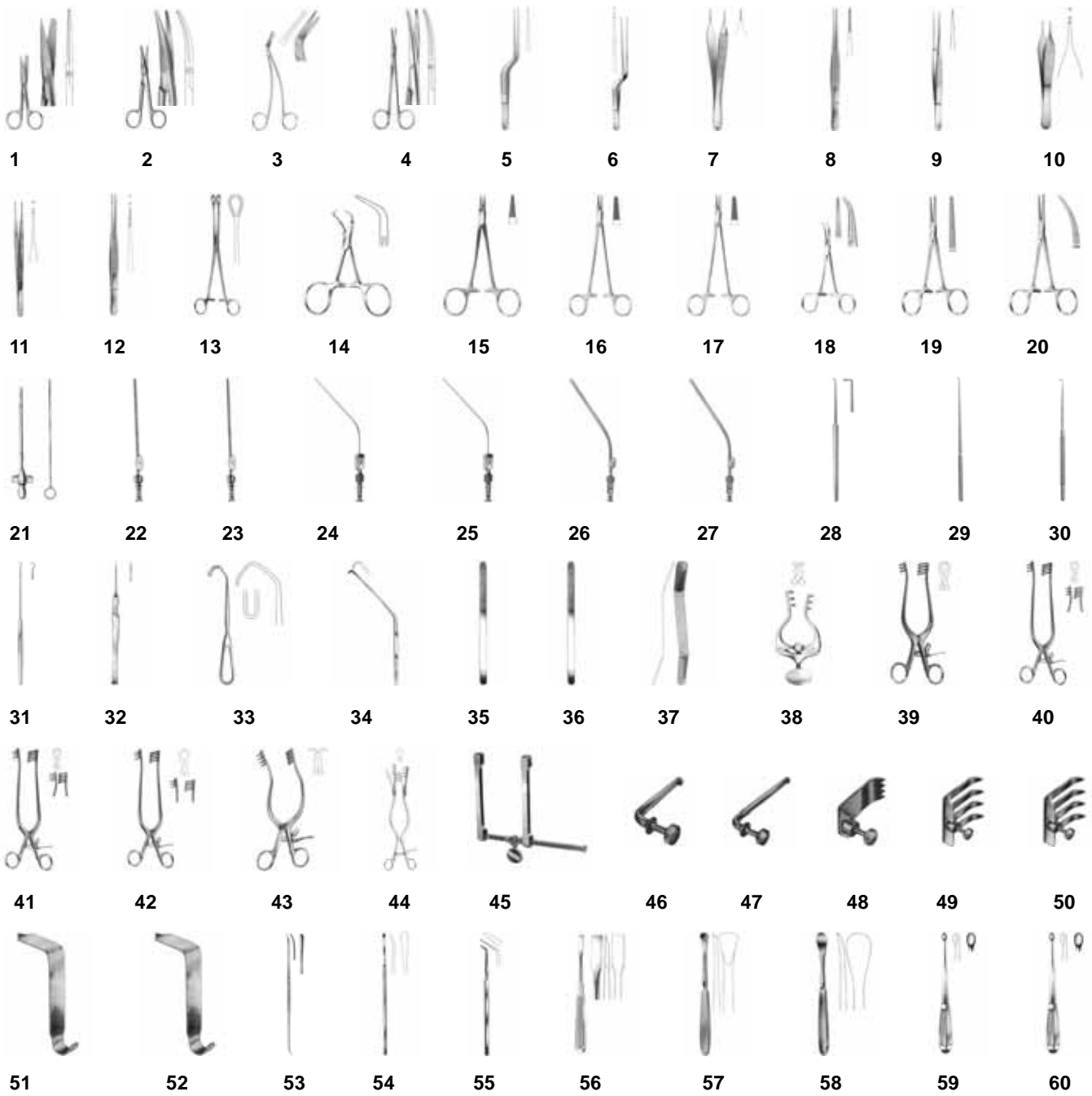

No	Quantity	Code	Description
1	1	C 310.03	Scissors Strag. 14.5cm
2	1	C 443.01	Mayo Stýle Scis. Curv 18cm
3	1	C 520.00	Schmýeden-Taylor Scýs. 15.5cm
4	1	C 753.00	Baby Metzenbaum Scis. HM 14.5cm
5	1	D 145.01	Lýgature Forc. Bayonet 18.5cm
6	2	D 154.00	Bayonet Forc. Teeth 20cm
7	2	D 204.00	Mýcro Adson Forc. 12cm
8	3	D 220.01	Cushýng Dýssec. Forc. Stra. 20cm
9	2	D 235.00	Dýssec. Forc. Straýght 18.5cm
10	2	D 323.00	Adson Týssue Forc. Teeth 12cm
11	3	D 365.00	Gerald Týssue Forc. Stra. Teeth 17.5cm
12	2	D 382.01	Waugh Týssue Forc. Stra. Teeth 20cm
13	2	E 086.00	Foerster-Ballanger Dres. Forc.Stra. 24cm
14	6	E 430.02	Backhaus Towel Clamp 13.5cm
15	18	F 326.00	Converse Needle Hol. Hard Met. 13cm
16	1	F 355.01	Hegar Ma Hard Met. Need. Hol Forc.18cm
17	1	F 355.02	Hegar Ma. Hard Met. Need. Hol. Forc. 20.5cm
18	1	G 238.00	Dandy Haemos. Forc. Curv. 14cm
19	24	G 240.00	Grýle Haemos. Forc. Stra. 14cm
20	12	G 241.00	Grýle Haemos. Forc. Curv. 14cm
21	12	J 200.01	Suctýon Tubes Ø2.5mm 7cm
22	2	J 208.00	Adson Suct. Tubes Ø2mm 15cm
23	2	J 208.02	Adson Suct. Tubes Ø4mm 15cm
24	2	J 214.01	Fergusson Suct. Tubes Ø2.5mm 18cm
25	2	J 214.03	Fergusson Suct. Tubes Ø4.0mm 18cm
26	2	J 222.00	Frazýer Suctýon Tubes Ø3mm 18cm
27	2	J 222.01	Frazýer Suctýon Tubes Ø5mm 18cm
28	2	K 104.01	Cushýng Vessel Hook 19cm
29	2	K 105.01	Dandy Vessel Hook 22cm
30	2	K 107.01	Adson Skin Hook 20cm
31	2	K 138.00	Gýljes Skin Hook 18cm
32	1	K 162.00	Lahey Dura Hook 13cm
33	1	K 279.00	Cushýng Retr. 20cm
34	1	K 280.02	Love Nerve Retr. 135° 22cm
35	1	K 561.01	Braýn Spat. Malle. 9mm 20cm
36	1	K 561.02	Braýn Spat. Malle. 12mm 20cm
37	1	K 565.01	Braýn Spat. Flex. 7+9mm 18cm
38	1	L 095.00	Jansen Retr. 10cm
39	2	L 350.00	Weytlaner Retr. Sharp 18cm
40	1	L 353.01	Weytlaner Retr. Sharp 19.5cm
41	1	L 354.01	Weytlaner Retr. Blunt 19.5cm
42	1	L 354.02	Weytlaner Retr. Blunt 24cm
43	1	L 356.00	Anderson Adson Retr. Sharp 19cm
44	2	L 370.02	Beckmann Adson Retr. Sharp 31cm
45	2	L 455.01	Scovýle Self Retr.
46	1	L 455.14	Scovýle Retr. Blade 50mm
47	1	L 455.16	Scovýle Retr. Blade 70mm
48	1	L 455.18	Scovýle Retr. Blade 65x25mm
49	1	L 455.26	Scovýle Retr. Blade 48x50mm
50	1	L 455.32	Scovýle Retr. Blade 80x57mm
51	1	L 482.00	Taylor Retr. 32x75mm
52	1	L 482.01	Taylor Retr. 32x100mm
53	1	M 115.01	Davýs Dissec. 24.5cm
54	1	M 180.01	Sachs Dissec. 21cm
55	1	M 182.00	Frazýer Dýssec. 15cm
56	1	M 240.01	Adson Rasp. 8mm 17cm
57	1	M 265.01	Langenbeck Rasp. 16mm 19cm
58	2	M 275.01	Sedýlot Rasp. 18mm 18.5cm
59	1	N 202.03	Hýbbs-Spratt Curet 3.5mm 20cm
60	1	N 202.04	Hýbbs-Spratt Curet 4.0mm 20cm

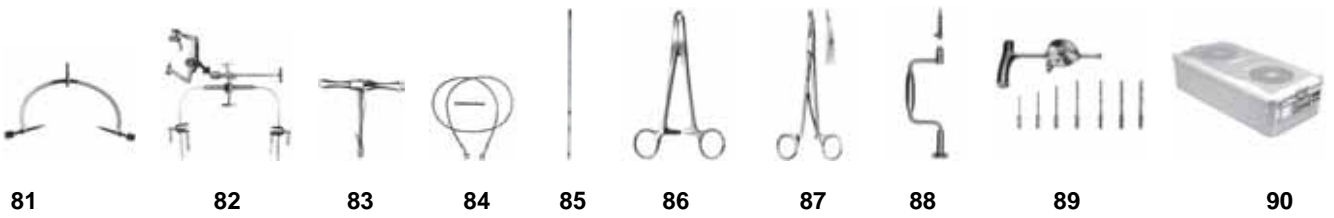
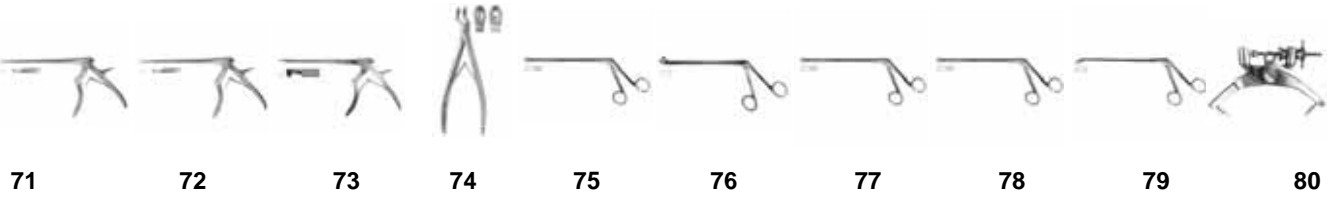
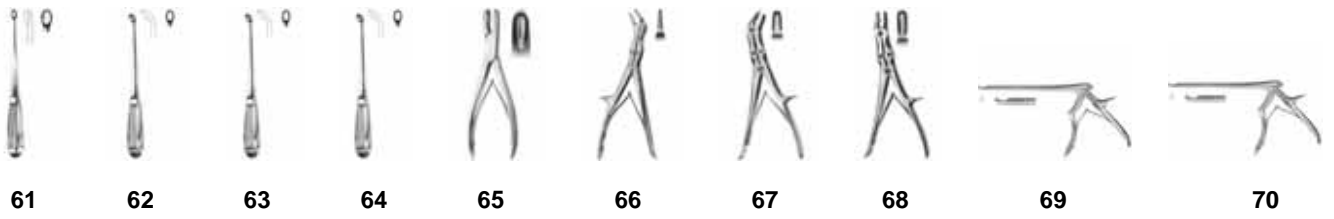

No	Quantity	Code	Description
61	1	S 510.00	Gardner-Wels Skull Tractýon
62	1	S 541.00	Set For Fixing Skull Clamp
63	2	T 530.00	GýglýWýre Saws Handle
64	10	T 536.01	GýglýWýre Saws 40cm
65	2	T 540.00	De Martel Guýde 35cm
66	1	T 550.00	Raney Applying Forc. 16cm
67	1	T 555.01	Mc Kenzýe Applying Forc. 19cm
68	1	V 500.00	Hudson Bone Perf. Comple
69	1	V 610.00	Stýle Hand Dryll Complette
70	1	N 202.05	Hýbbs-Spratt Curet 4.5mm 20mm
71	1	N 203.03	Hýbbs-Spratt Curet Curv. 3.5mm 20cm
72	1	N 203.04	Hýbbs-Spratt Curet Curv. 4.0mm 20cm
73	1	N 203.05	Hýbbs-Spratt Curet Curv. 4.5mm 20cm
74	1	P 295.00	Luer Bone Rong. 18cm
75	1	P 310.01	Echlýn Bone Rong. 23cm
76	1	P 315.01	Stýle Bone Rong. 23.5cm
77	1	P 316.01	Leksell-Stýle Bone Rong. 24cm
78	1	P 430.02	Kerrýson Punc. 3mm 18cm
79	1	P 430.04	Kerrýson Punc. 5mm 18cm
80	1	P 431.02	Kerrýson Punc. 3mm 18cm
81	1	P 431.04	Kerrýson Punc. 5mm 18cm
82	1	P 433.04	Kerrýson Punc. 5mm 18cm
83	1	P 572.00	Dura Protectors 20.5cm
84	1	R 380.00	Cushýng Rong. Stra. 2x10mm 18cm
85	1	R 383.01	Gruenwald Rong. Stra. 3x10mm 18cm
86	1	R 384.01	Gruenwald Rong. Curv. 3x10mm 18cm
87	1	R 386.02	Spurlýng Rong. Stra. 4x10mm 18cm
88	1	R 388.02	Spurlýng Rong. Curv. 4x10mm 18cm
89	1	S 500.00	Crutchfýeld Skull Tractýon
90	1	Y 110.15	1/1 Sýze Cont. 580x280x150mm
91	2	Y 190.07	Wýre Basket 485x255x70mm
92	1	Y 851.00	Slicon Mat 245x245 mm

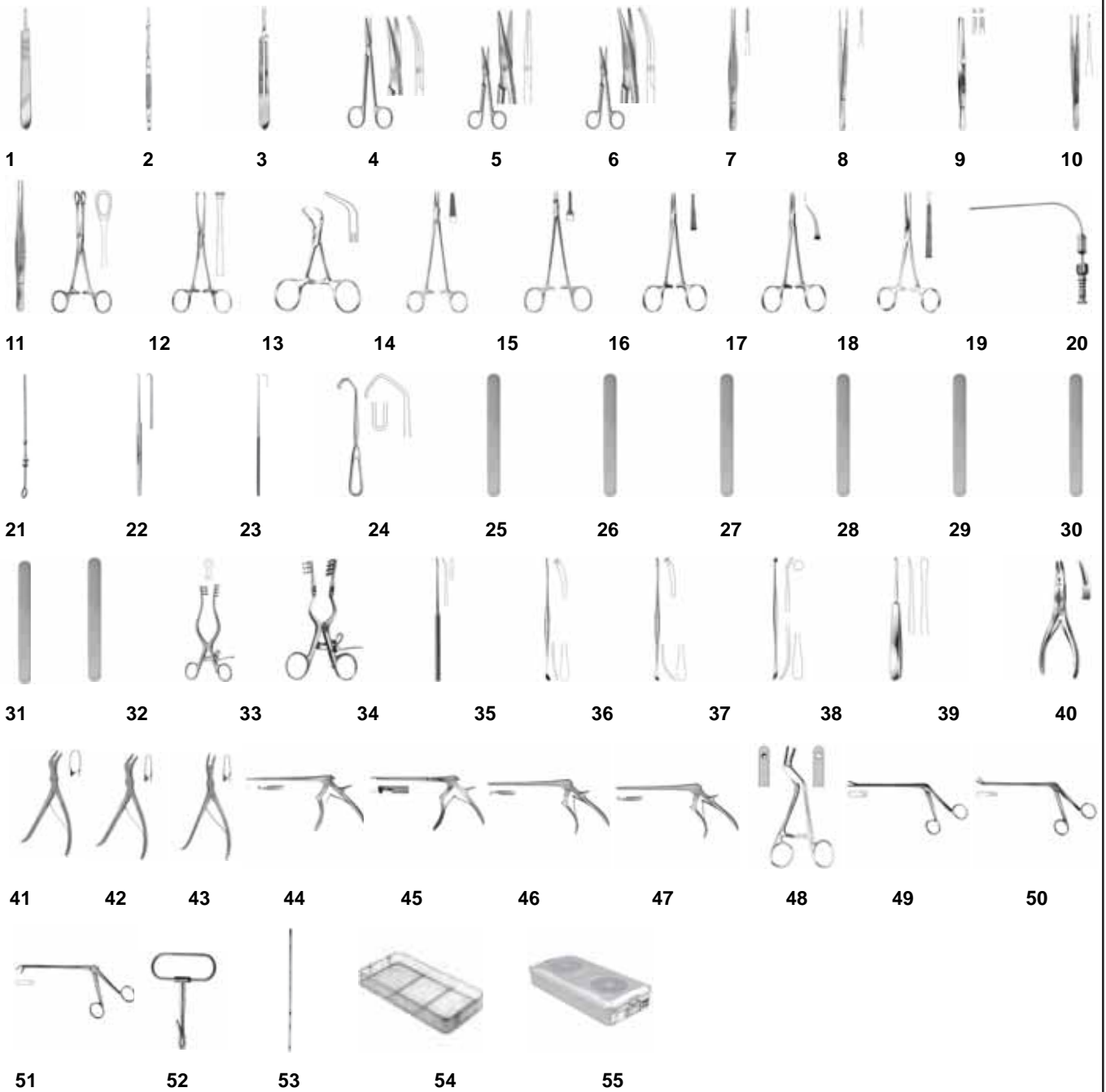

No	Quantity	Code	Description
1	2	B 030.01	Scalpel Handle 13.5 cm
2	2	B 032.00	Scalpel Handle 16.5 cm
3	1	B 040.01	Scalpel Handle 13.5 cm
4	1	C 421.01	Backhaus Towel Clamp 9 cm
5	1	C 442.01	Mayo scissors, straight 17 cm
6	1	C 443.01	Mayo scissors, curved 17 cm
7	2	D 220.00	Pots Smith Dissecting Forceps 18 cm
8	1	D 232.00	Gerald Dissecting Forcep 17.5 cm
9	2	D 341.00	Brown Tissue Forceps 18 cm
10	1	D 365.00	Gerald Tissue Forceps 17.5 cm
11	2	D 382.00	Pots Smith Tissue Forceps 18 cm
12	3	E 082.00	Sponge forceps, straight, serr 18 cm
13	12	E 144.00	Allis Tissue Forceps 5 x 6 teeth 16.5 cm
14	30	E 430.00	Backhaus Towel Clamp 9 cm
15	4	F 355.01	Hegar Mayo Needle Holder 15 cm
16	4	F 380.02	Ryder Needle Holder 17.5 cm
17	12	G 206.00	Halsted Mosquito Forceps 12.5 cm
18	75	G 211.00	Halsted Delicate Forceps 1 x 2 teeth 12.5 cm
19	3	G 448.00	Kocher Forceps, straight 16 cm
20	1	J 217.00	Frazier Suction Tube Ø2 mm 19 cm
21	1	J 740.00	Elsberg Cannula Ø1.7 mm 10 cm
22	1	K 134.00	Cottle Dura Hook 16 cm
23	1	K 139.01	Adson Nerve Hook 22 cm
24	2	K 279.00	Cushing Retractor 20 cm
25	1	K 562.10	Brain Spatula Malleable 6 mm 18 cm
26	1	K 562.12	Brain Spatula Malleable 10 mm 18 cm
27	1	K 562.14	Brain Spatula Malleable 14 mm 18 cm
28	1	K 562.15	Brain Spatula Malleable 16 mm 18 cm
29	1	K 562.16	Brain Spatula Malleable 18 mm 18 cm
30	1	K 562.19	Brain Spatula Malleable 25 mm 18 cm
31	1	K 562.21	Brain Spatula Malleable 32 mm 18 cm
32	1	K 562.25	Brain Spatula Malleable 38 mm 18 cm
33	2	L 313.00	Waitlanier Retractor Blunt 16.5 cm
34	2	L 331.02	Adson Baby Retractor Blunt 14 cm
35	1	M 154.01	Penfield Dessectors 21.5 cm
36	1	M 175.01	Penfield Dessectors 19.5 cm
37	1	M 175.02	Penfield Dessectors 19.5 cm
38	1	M 178.00	Penfield Dessectors 17.5 cm
39	1	M 337.01	Sebilau Bone Level 17.5 cm
40	1	P 300.00	Böhler Bone Ronguer curved 15.5 cm
41	1	P 347.02	Lexell Bone Ronguer 8 mm 23 cm
42	1	P 347.01	Lexell Bone Ronguer 5 mm 23 cm
43	1	P 346.01	Lexell Bone Ronguer 5 mm 23 cm
44	1	P 431.02	Ferris Smith- Kerrison Punch 3 mm 18 cm
45	1	P 433.02	Ferris Smith- Kerrison Punch 3 mm 18 cm
46	1	P 434.10	Punch Upward 90° 3 mm 17.5 cm
47	1	P 435.10	Punch 3 mm 17.5 cm
48	1	P 570.00	Adson Drill Guide 15 cm
49	1	R 375.01	Caspar Ronguer 3 mm 15.5 cm
50	1	R 377.01	Caspar Ronguer 3 mm 15.5 cm
51	1	R 379.01	Caspar Ronguer 3 mm 15.5 cm
52	1	T 533.00	Sturly Saw Handle Loop 9.5 cm
53	2	T 540.00	De Martel Saw guide 35 cm
54	1	Y 190.07	Wire Basket, 485x255x70 mm
55	1	Y 110.10	1/1 Size Container, 580x280x100 mm

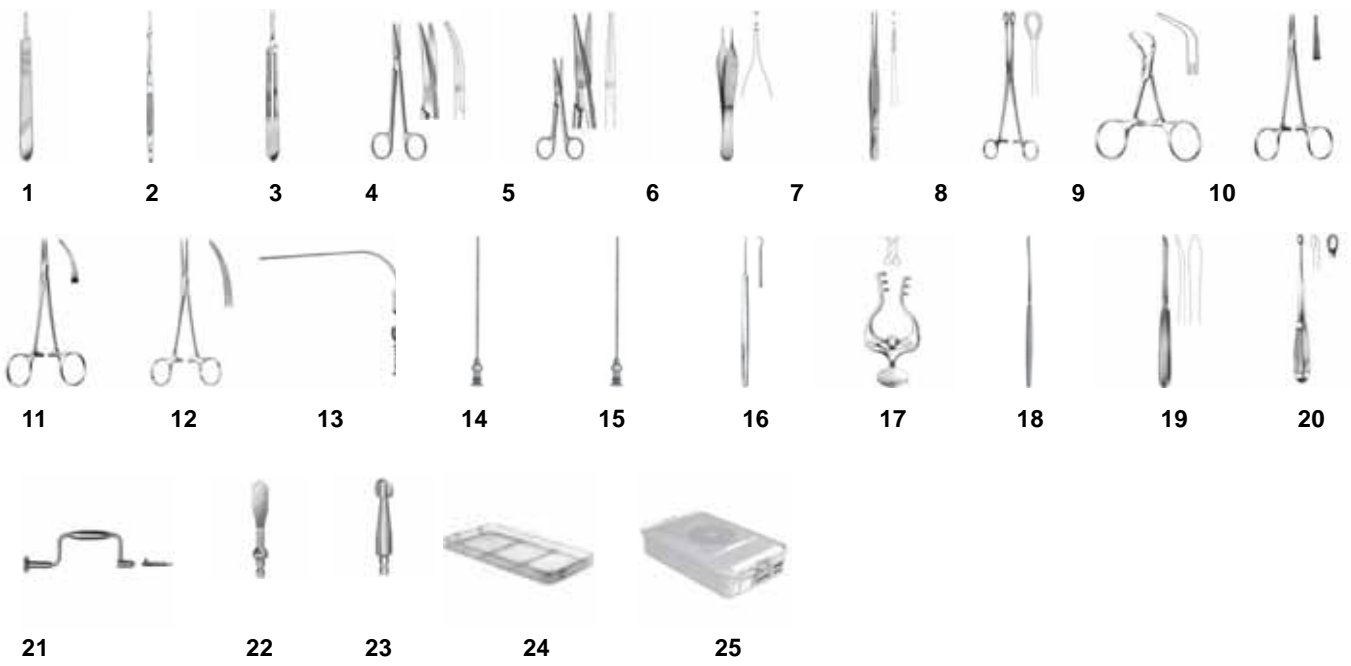

No	Quantity	Code	Description
1	2	B 030.01	Scalpel Handle, 13.5 cm
2	1	B 032.00	Scalpel Handle, 16.5 cm
3	1	B 040.01	Scalpel Handle, 13.5 cm
4	1	C 421.01	Metzenbaum Dissecting Scissors, Curved, 18 cm
5	2	C 442.00	Mayo-Stille Surgical Scissors, Straight, 14 cm
6	1	D 323.00	Adson Delicate Tissue Forceps, 1x2 teeth 12 cm
7	2	D 382.00	Waugh Tissue Forceps, 18 cm
8	4	E 086.00	Sponge Forceps, straight, 24 cm
9	6	E 430.02	Backhaus Towel Clamps, 13.5 cm
10	3	G 206.00	Micro-Halsted Delicate Haemostatic Forceps, straight, 12.5 cm
11	6	G 207.00	Micro-Halsted Delicate Haemostatic Forceps, curved, 12.5 cm
12	6	G 265.00	Crile Delicate Haemostatic Forceps, curved, 16 cm
13	1	J 217.02	Frazier Tube, angled, Ø 4 mm, 19 cm
14	2	J 731.01	Cone Ventricular Needle, Ø 1.0 mm, 9 cm
15	2	J 731.02	Cone Ventricular Needle, Ø 1.2 mm, 9 cm
16	1	K 122.00	Frazier Dural Hook, 13 cm
17	2	L 095.00	Jansen Self-Retaining Retractor, blunt, 10 cm
18	1	M 247.01	Sunday Bone Level, 30 cm
19	1	M 341.01	Langenbeck Bone Levels, 19.5 cm
20	1	N 202.05	Hibs-Spratt Bone Curette, 20 cm
21	1	V 500.00	Hudson Brace Snap-Lock complete
22	1	V 500.03	Cushing Perforator Drill, Ø 14 mm
23	1	V 500.08	Adson Perforator Drill, Ø 15 mm
24	1	Y 290.05	Wire Basket 405x255x50mm
25	1	Y 210.10	1/1 Size Cont. 465x280x100mm

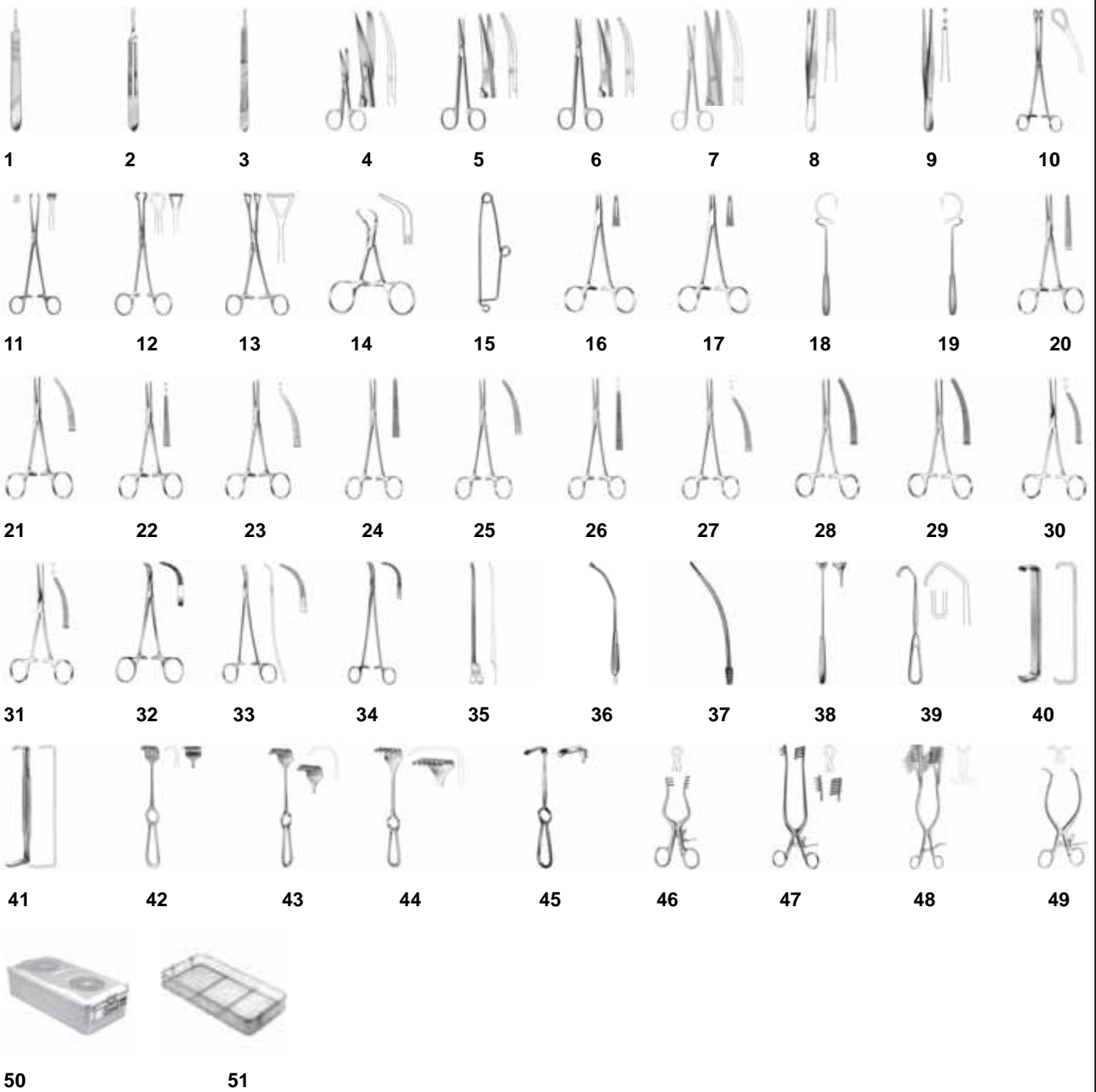

1	1	B 030.01	Scalpel Handle 3no 13.5cm
2	1	B 040.01	Scalpel Handle 4no 13.5cm
3	1	B 040.02	Scalpel Handle 4 No 21 cm
4	1	C 311.03	Standart Scissors Curved 14 cm
5	1	C 421.00	Metzenbaum Scissors Curved 16 cm
6	2	C 421.01	Metzenbaum Scissors Curved 18 cm
7	2	C 459.00	Mayo - Lexer Scissors Curved 17 cm
8	2	D 240.03	Standart Forcep Straight 16 cm
9	2	D 360.04	Standart Forcep Teeth 16 cm
10	2	E 087.00	Foerster - Ballanger Dressing Forcep 24 cm
11	1	E 150.00	Allis Tissue Grasping Forcep, 15.5 cm
12	1	E 174.00	Babcook Organ and Tissue Grasping Forcep, 16 cm
13	1	E 187.00	Duval Atraumatic Forcep 20 cm
14	16	E 430.01	Backhause Towell Clamp 13 cm
15	8	E 481.00	Mayo Safety Pin, 14 cm
16	2	F 230.01	Mayo - Hegar Needle Holder 18 cm
17	1	F 230.02	Mayo - Hegar Needle Holder 20 cm
18	1	F 440.00	Deschamps Left 24 cm
19	1	F 441.00	Deschamps Right 24 cm
20	2	G 240.00	Crile Haemostatic Forcep Straight 14 cm
21	4	G 241.00	Crile Haemostatic Forcep Curved14 cm
22	4	G 244.00	Crile Haemostatic Forcep Straight Teeth 14 cm
23	8	G 245.00	Crile Haemostatic Forcep Curved Teeth 14 cm
24	2	G 264.00	Crile Haemostatic Forcep Straight 16 cm
25	4	G 265.00	Crile Haemostatic Forcep Curved16 cm
26	4	G 268.00	Crile Haemostatic Forcep Straight Teeth 16 cm
27	8	G 269.00	Crile Haemostatic Forcep Curved16 cm
28	2	G 431.01	Kocher Haemostatic Forcep Curved18 cm
29	2	G 431.02	Kocher Haemostatic Forcep Curved20 cm
30	3	G 449.01	Kocher Haemostatic Forcep Curved Teeth 18 cm
31	3	G 449.02	Kocher Haemostatic Forcep Curved Teeth 20 cm
32	1	G 616.01	Baby - Mixer Dissecting Forcep 18 cm
33	1	G 618.02	Dissecting Forcep 21 cm
34	1	G 654.00	Mixer Dissecting Forcep 23 cm
35	2	J 012.00	Doyen Probe 14 cm
36	1	J 300.00	Yankauer Suction Tube 28.5 cm
37	1	J 352.00	Suction Tube 16 cm
38	1	K 274.01	Cushing Retractor 25 cm
39	1	K 279.00	Cushing Retractor 22 cm
40	1	K 311.00	Farabeuf Retractor 15 cm
41	1	K 342.00	Us -army Retractor 22 cm
42	2	K 432.03	Volkman Retractor 22 cm
43	2	K 438.00	Korte -Wagner Retractor 28 cm
44	2	K 444.02	Israel Retractor Blunt 23 cm
45	2	K 452.05	Kocher - Langenbeck Retractor 22 cm
46	2	L 305.00	Weitlaner Self-Retaining Retractor Sharp 13 cm
47	2	L 353.02	Weitlaner Self-Retaining Retractor Sharp 25 cm
48	2	L 377.02	Beckmann - Eaton Self-Retaining Retractor 32 cm
49	2	L 409.00	Gelpy Self-Retaining Retractor 17 cm
50	2	Y 110.15	Container 580 X 280 X 150 cm
51	2	Y 191.05	Wire Basket 540 X 250 X 50 cm

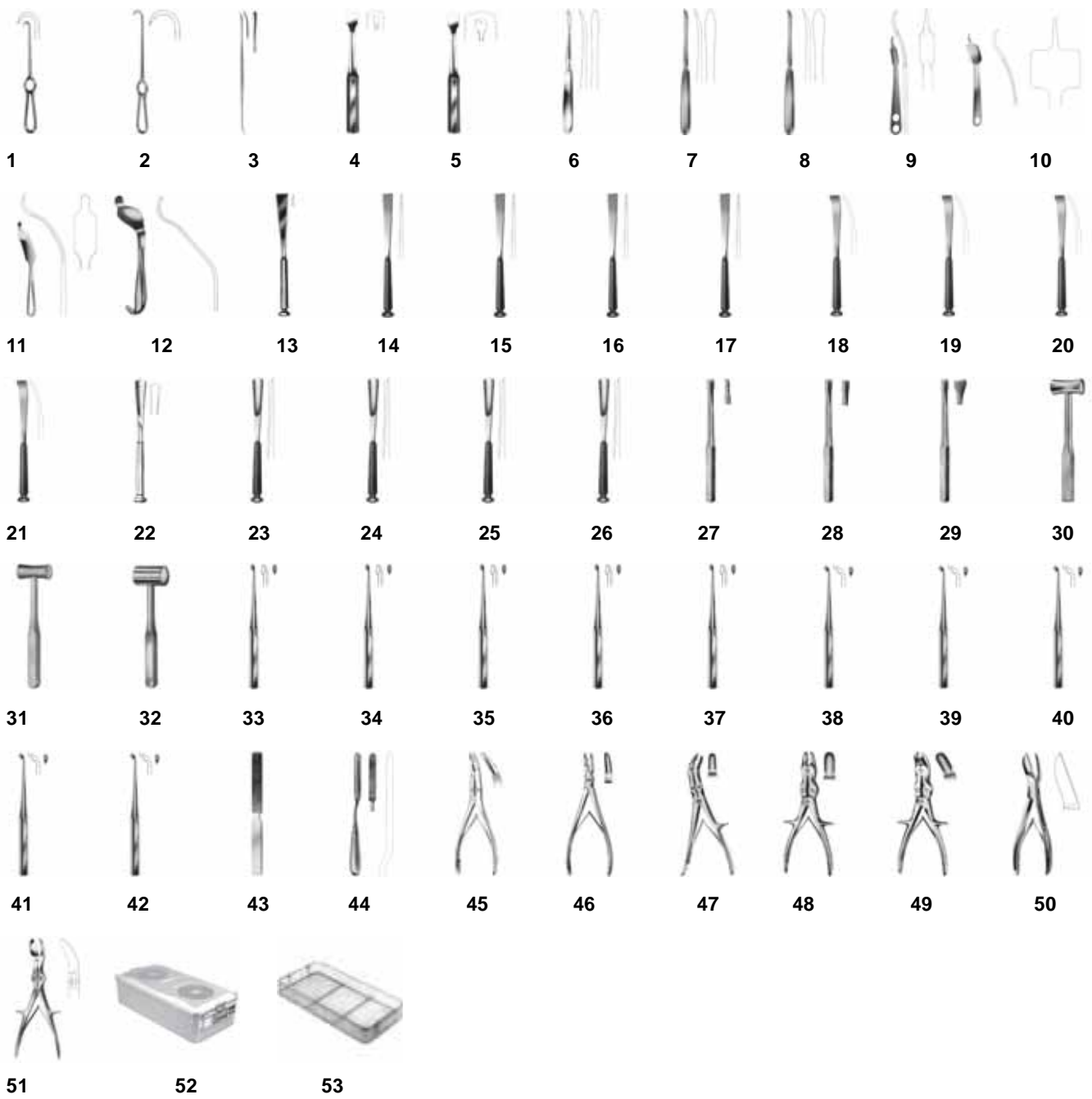

1	2	K 402.00	Kocher Retractor 22 cm
2	2	K 408.00	Volkman Retractor 24.5 cm
3	1	M 115.01	Davis Raspatorie 24 cm
4	1	M 300.02	Key Periost Bone Lever 13 mm 18 cm
5	1	M 300.04	Key Periost Bone Lever 25 mm 20 cm
6	1	M 340.01	Quervain Elevator 6 mm 20 cm
7	1	M 341.01	Langenbeck Elevator 8 mm 20 cm
8	1	M 341.02	Langenbeck Elevator 10 mm 20 cm
9	2	M 411.02	Hohman Bone Lever 24 cm
10	2	M 416.02	Verbrugge - Muller Bone Lever 25.5 cm
11	2	M 421.03	Lange - Hohmann Bone Lever 29 cm
12	2	M 435.02	Bennet Bone Lever 25 cm
13	1	M 650.03	Stille Osteotome Straight 8 mm 20 cm
14	1	M 650.04	Stille Osteotome Straight 10 mm 20 cm
15	1	M 650.06	Stille Osteotome Straight 15 mm 20 cm
16	1	M 650.07	Stille Osteotome Straight 20 mm 20 cm
17	1	M 650.08	Stille Osteotome Straight 25 mm 20 cm
18	1	M 654.04	Stille Osteotome 10 mm 20 cm
19	1	M 654.06	Stille Osteotome 15 mm 20 cm
20	1	M 654.07	Stille Osteotome 20 mm 20 cm
21	1	M 654.08	Stille Osteotome 25 mm 20 cm
22	1	M 656.03	Stille Gouge 8 mm 20 cm
23	1	M 656.04	Stille Gouge 10 mm 20 cm
24	1	M 656.06	Stille Gouge 15 mm 20 cm
25	1	M 656.07	Stille Gouge 20 mm 20 cm
26	1	M 656.08	Stille Gouge 25 mm 20 cm
27	1	M 754.01	Tamper 8 mm 20 cm
28	1	M 754.02	Tamper 10 x 5 mm 20 cm
29	1	M 754.03	Tamper 8 x 3 mm 20 cm
30	1	M 818.01	Bergmann Mallet 150 gr 15 cm
31	1	M 818.02	Bergmann Mallet 300 gr 23 cm
32	1	M 820.02	Ombredanne Mallet 550 gr 24 cm
33	1	N 210.01	Brun Bone Curette 000 No Straight 22 cm
34	1	N 210.03	Brun Bone Curette 0 No Straight 22 cm
35	1	N 210.05	Brun Bone Curette 2 No Straight 22 cm
36	1	N 210.07	Brun Bone Curette 4 No Straight 22 cm
37	1	N 210.09	Brun Bone Curette 6 No Straight 22 cm
38	1	N 211.01	Brun Bone Curette 000 No Curved 22 cm
39	1	N 211.03	Brun Bone Curette 0 No Curved 22 cm
40	1	N 211.05	Brun Bone Curette 2 No Curved 22 cm
41	1	N 211.07	Brun Bone Curette 4 No Curved 22 cm
42	1	N 211.09	Brun Bone Curette 6 No Curved 22 cm
43	1	N 335.01	Raspatorie 22 cm
44	1	N 340.01	Raspatorie 25 cm
45	1	P 304.01	Mayfield Rongeur 17 cm
46	1	P 309.01	Rottgen- Ruskin Rongeur 24 cm
47	1	P 315.01	Stille Rongeur 23 cm
48	1	P 320.01	Luer -Stille Rongeur 22 cm
49	1	P 321.01	Luer -Stille Rongeur 22 cm
50	1	P 359.03	Liston Scissors 19 cm
51	1	P 377.01	Liston Scissors 28 cm
52	2	Y 110.15	Container 580 x 280 x 150 mm
53	2	Y 191.05	Wire Basket 540 x 250 x 50 mm

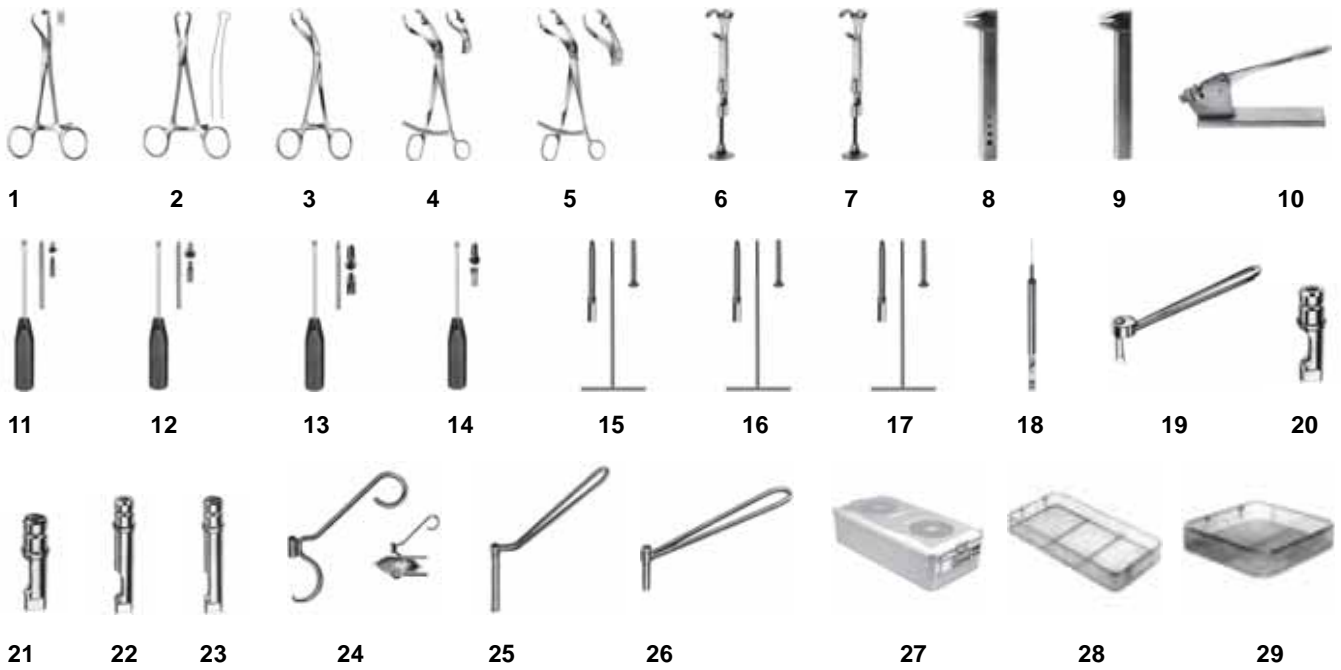

1	1	P 121.00	Bone Holding Forcep 13.5 cm
2	1	P 123.00	Bone Holding Forcep 13.5 cm
3	2	P 171.00	Verbrugge Bone Holding Forcep 17 cm
4	2	P 172.01	Verbrugge Bone Holding Forcep 25 cm
5	2	P 172.03	Verbrugge Bone Holding Forcep 27 cm
6	2	P 180.00	Lowman Bone Holding Forcep 18.5 cm
7	2	P 180.01	Lowman Bone Holding Forcep 20 cm
8	1	T 623.00	Jewett Bending Iron 20 cm
9	1	T 623.01	Jewett Bending Iron 20 cm
10	1	T 625.00	Plate Bending and Contouring Device
11	1	V 620.04	Screwdriver 2.5 mm 25 cm
12	2	V 620.05	Screwdriver 3.5 mm 25 cm
13	1	V 621.03	Phillips Screwdriver 25 cm
14	1	V 623.01	Screwdriver Straight 25 cm
15	2	V 645.02	Bone Tap 3.5 mm 17 cm
16	1	V 645.03	Bone Tap 4.0 mm 20 cm
17	1	V 645.04	Bone Tap 4.5 mm 22 cm
18	1	V 648.00	Screw Depth Gauges 22 cm
19	1	V 652.00	Drill Guide Handle
20	1	V 657.00	Drill Guide 3,2 mm, 4 cm
21	1	V 657.01	Drill Guide 3,2 mm, 4 cm
22	1	V 657.02	Drill Guide 3.2 mm 6 cm
23	1	V 657.03	Drill Guide 3.2 mm 6 cm
24	1	V 666.00	Drill Guide Ø 6.5 mm
25	1	V 667.01	Tissue Protector Sheath 4.5 mm
26	1	V 669.00	Tissue Protector Sheath 3.5 mm
27	1	Y 110.15	Container 580 x 280 x 150 mm
28	1	Y 191.05	Wire Basket 540 x 250 x 50 mm
29	1	Y 390.03	Wire Basket 255 x 245 x 30 mm



1



2



3



4



5



6



7



8



9



10



11



12



13



14



15



16



17



18



19



20



21



22



23



24



25



26



27



28



29



30



31



32



33

1	1	T 685.00	Dura Protector 10 cm
2	1	T 688.00	Kuntscher Impactor 13 cm
3	1	T 689.00	Kuntscher Impactor 21 cm
4	1	T 689.01	Kuntscher Impactor 17 cm
5	1	T 690.00	Kuntscher Impactor-Extractor 50 cm
6	1	T 729.00	"T" Wrench, for Malleable Reamers
7	1	V 720.01	Kuntscher Reamer 26 cm
8	1	V 721.00	Kuntscher Reamer 36 cm
9	1	V 725.06	Fixed Reamer 6 mm
10	1	V 725.07	Fixed Reamer 7 mm
11	1	V 725.08	Fixed Reamer 8 mm
12	1	V 725.09	Fixed Reamer 9 mm
13	1	V 725.10	Fixed Reamer 10 mm
14	1	V 725.11	Fixed Reamer 11 mm
15	1	V 725.12	Fixed Reamer 12 mm
16	1	V 725.13	Fixed Reamer 13 mm
17	1	V 725.14	Fixed Reamer 14 mm
18	1	V 725.15	Fixed Reamer 15 mm
19	1	V 725.16	Fixed Reamer 16 mm
20	1	V 727.06	Malleable Reamer 6 mm
21	1	V 727.07	Malleable Reamer 7 mm
22	1	V 727.08	Malleable Reamer 8 mm
23	1	V 727.09	Malleable Reamer 9 mm
24	1	V 727.10	Malleable Reamer 10 mm
25	1	V 727.11	Malleable Reamer 11 mm
26	1	V 727.12	Malleable Reamer 12 mm
27	1	V 727.13	Malleable Reamer 13 mm
28	1	V 727.14	Malleable Reamer 14 mm
29	1	V 727.15	Malleable Reamer 15 mm
30	1	V 727.16	Malleable Reamer 16 mm
31	1	V 728.05	Kuntscher Wire Guide 4 mm 50 cm
32	1	Y 110.13	Container 580 x 280 x 135 mm
33	2	Y 191.05	Wire Basket 540 x 250 x 50 mm



11



12



13

1	1	B 515.00	Smille Meniscus Knives Right 17 cm
2	1	B 516.00	Smille Meniscus Knives Left 17 cm
3	1	B 517.00	Smille Meniscus Knives Straight 17 cm
4	1	K 470.00	Smille Meniscus Retractor 20 x 20 mm 17 cm
5	1	K 470.01	Smille Meniscus Retractor 32 x 20 mm 17 cm
6	1	K 470.02	Smille Meniscus Retractor 41 x 20 mm 17 cm
7	1	K 470.03	Smille Meniscus Retractor 57 x 20 mm 17 cm
8	1	K 470.04	Smille Meniscus Retractor 12 x 60 mm 17 cm
9	1	K 477.00	Blount Meniscus Retractor 40 x 5 mm
10	1	P 660.00	Bircher - Ganske Meniscus Forcep 20 cm
11	1	P 664.00	Martin Meniscus Forcep 20 cm
12	1	Y 310.10	Container 285 x 280 x 100 mm
13	1	Y 390.05	Wire Basket 250 x 245 x 50 mm

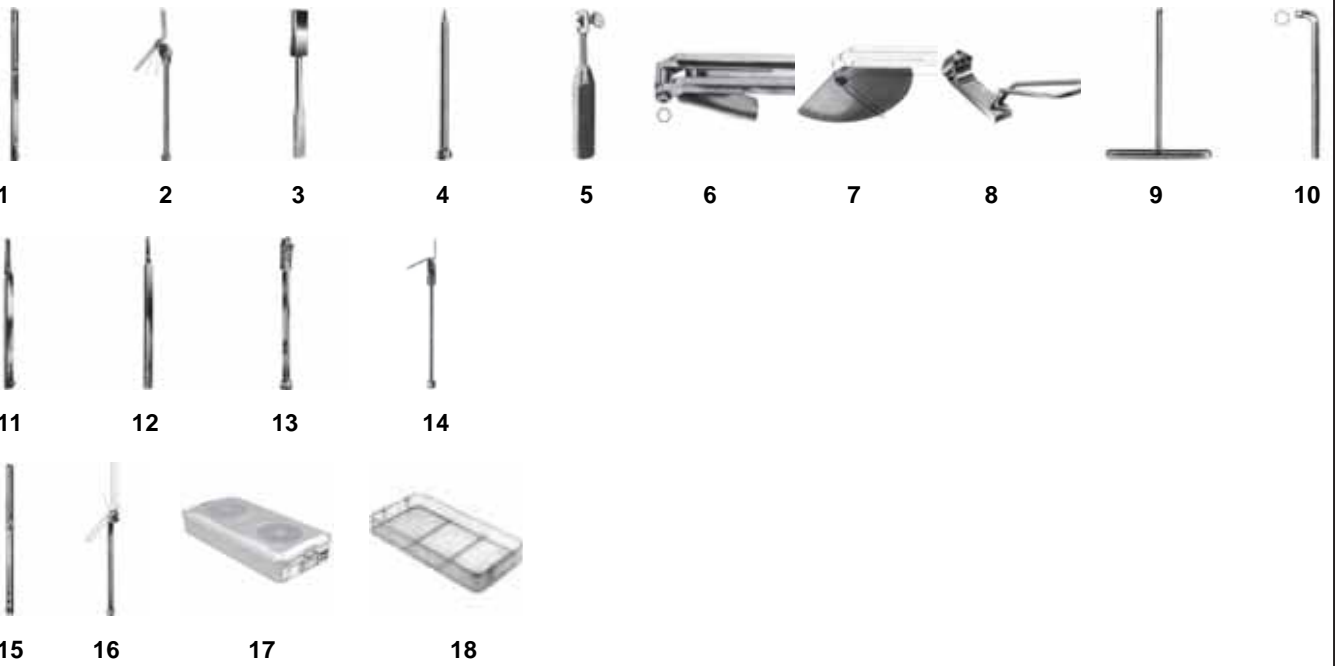

“” Plak için;

1	1	T 656.00	Impactor 26 cm
2	1	T 653.00	Impactor-Extractor 27 cm
3	1	T 663.00	Slotted Mallet 29 cm
4	1	T 660.00	Impactor 21 cm
5	1	T 661.00	Guide Handle 19 cm
6	1	T 668.00	Sliding Guide 3.5 mm
7	1	T 669.00	Angular Guide for Chisel Guide
8	1	T 665.00	Drill Guide
9	1	V 702.00	“ T ” Wrench 18 cm
10	1	V 701.00	“ L ” Wrench 12 cm

“” Plak için;

11	1	T 651.00	Impactor 12 mm 26 cm
12	1	T 650.00	Impactor 8 mm 26 cm
13	1	T 652.00	Impactor-Extractor 26 cm
14	1	T 654.00	Impactor-Extractor 26 cm

“” Plak için;

15	1	T 657.00	Impactor 10 mm 28 cm
16	1	T 655.00	Impactor-Extractor 26.5 cm
17	1	Y 110.10	Container 580 x 280 x 100 mm
18	1	Y 191.05	Wire Basket 540 x 250 x 50 mm



1



2



3



4



5



6



7



8



9

1	1	T 640.00	Angle Measuring Instrument, 10 cm
2	1	V 690.00	Uzatma Mili, 14 cm
3	1	V 691.00	Reamer, 18 cm
4	1	V 692.00	Reamer, 23 cm
5	1	V 693.00	Tap
6	1	V 694.00	" T " Handle, 25 cm
7	1	V 695.00	Pin Fixing rod, 30 cm
8	1	V 696.00	Guide Wire, 28 cm
9	1	Y 410.07	Container 300 x 135 x 70 mm



1



2



3



4



5



6



7



8



9



10



11



12



13



14



15



16



17



18



19



20



21



22



23



24



25



26



27

1	1	F 334.00	Needle Holder HM 15 cm
2	1	F 336.00	Needle Holder HM 15 cm
3	1	F 458.00	Obwegeser Reamer 19.5 cm
4	1	F 532.01	Wire Guide 22.5 cm
5	1	F 531.01	Wire Guide 24 cm
6	1	F 530.02	Demel Wire Guide 28.5 cm
7	1	F 522.00	Demel Wire Tightening and Twisting Forcep 27 cm
8	1	F 526.00	Jordan Wire Catcher 18 cm
9	1	F 525.00	Jordan Wire Twister 17 cm
10	1	F 527.00	Jordan Probe, Cannulated 17 cm
11	1	P 613.00	Wire Holding Forcep 17 cm
12	1	P 614.00	Wire Holding Forcep 19 cm
13	1	P 632.00	Wire Cutting Scissors HM 14 cm
14	1	P 643.00	Wire Cutting Forcep HM 23 cm
15	1	F 529.00	Wire Soft 0.2 mm
16	1	F 529.01	Wire Soft 0.3 mm
17	1	F 529.02	Wire Soft 0.4 mm
18	1	F 529.03	Wire Soft 0.5 mm
19	1	F 529.04	Wire Soft 0.6 mm
20	1	F 529.05	Wire Soft 0.7 mm
21	1	F 529.06	Wire Soft 0.8 mm
22	1	F 529.07	Wire Soft 0.9 mm
23	1	F 529.08	Wire Soft 1.0 mm
24	1	F 529.09	Wire Soft 1.2 mm
25	1	F 529.10	Wire Soft 1.5 mm
26	1	Y 310.15	Container 285 x 280 x 150 mm
27	2	Y 390.05	Wire Basket 250 x 245 x 50 mm



1



2



3



4



5



6



7



8



9

1	1	M 711.03	Gouge, 9 mm, 22 cm
2	1	P 675.00	Screw Removing Forcep, 20 cm
3	1	V 710.00	Screw Removing Tap, 2.5 mm
4	1	V 710.01	Screw Removing Tap, 3.2 mm
5	1	V 711.00	Screwdriver, 3.5 mm, Hexagonal, 18 cm
6	1	V 712.00	Screw Edge Cutter, 10 cm
7	1	V 712.10	Reamer, 17 cm
8	1	V 713.00	Reverse Inserewing Arm, 10 cm
9	1	Y 410.07	Container 300 x 135 x 70 mm

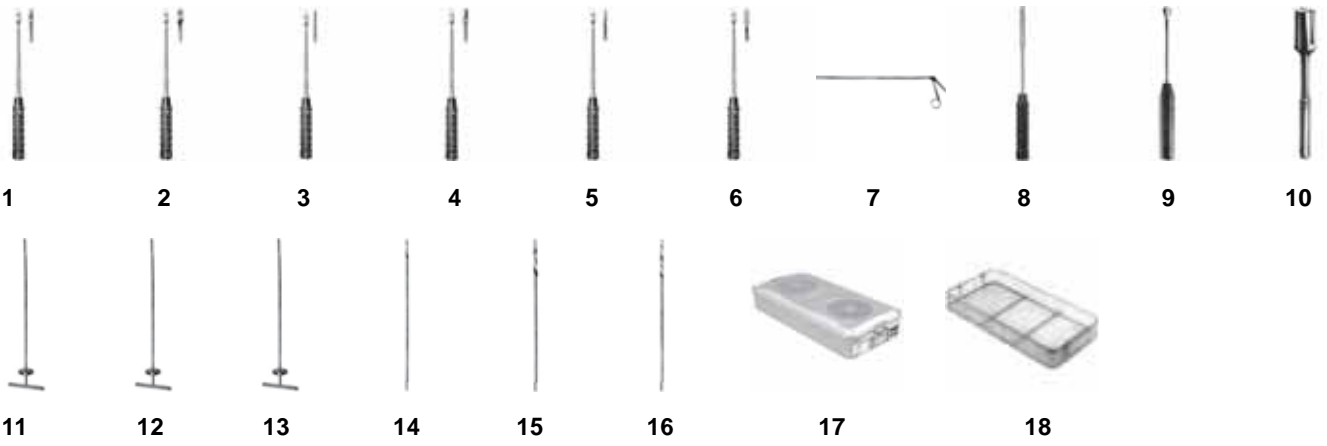

1	1	M 745.00	Osteotome 5 mm 35 cm
2	1	M 745.02	Osteotome 10 mm 35 cm
3	1	M 746.00	Gouge 5 mm 35 cm
4	1	M 746.02	Gouge 10 mm 35 cm
5	1	M 747.00	Gouge 5 mm 35 cm
6	1	M 747.02	Gouge 10 mm 35 cm
7	1	R 780.00	Cement Forceps 40 cm
8	1	T 720.00	Cement Pusher Round 20 cm
9	1	T 721.00	Cement Pusher Square 28 cm
10	1	T 725.00	Mallet 30 cm
11	1	T 726.00	Cement Extractor 0.7 mm 40 cm
12	1	T 726.01	Cement Extractor 0.9 mm 40 cm
13	1	T 726.02	Cement Extractor 0.11 mm 40 cm
14	1	V 735.00	Cement Scissors 0.6 mm 40 cm
15	1	V 736.00	Cement Scissors 0.8 mm 40 cm
16	1	V 737.00	Cement Scissors 0.10 mm 40 cm
17	1	Y 110.10	Container 580 x 280 x 100 mm
18	1	Y 191.05	Wire Basket 540 x 250 x 50 mm



1



2



3



4



5



6



7



8



9



10



11



12



13



14

1	1	D 575.00	Forcep, 16 cm
2	2	P 617.00	Wire Twisting Forcep, 13 cm
3	1	P 640.00	Reil Wire Cutting Forcep, 17.5 cm
4	1	P 683.00	Plate Bender, 15 cm
5	1	T 745.00	Screwdriver, 15 cm
6	1	T 746.00	Screwdriver, 15 cm
7	1	T 749.00	Depth Measuring Instrument, 20 cm
8	1	V 750.00	Drill, 1.5 mm
9	1	V 752.00	Drill Guide, 20 cm
10	1	V 754.00	Drill Guide, 23 cm
11	1	V 754.05	Drill Guide, Ø 2.5 mm
12	1	V 754.06	Drill Guide, Ø 2.5 mm
13	1	Y 310.10	Container, 285 x 280 x100 mm
14	1	Y 390.05	Wire Basket, 250 x 245 x 50 mm



1



2



3



4



5



6



7

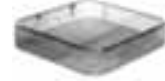

8

1	1	M 813.01	Mallet 19 cm
2	1	T 680.00	Extractor 40 cm
3	1	T 682.00	Impactor 20 cm
4	1	T 683.00	Holder 20 cm
5	1	V 715.00	Drill 0.5 mm 20 cm
6	1	V 716.00	Drill 0.7 mm 20 cm
7	1	Y 310.10	Container 285 x 280 x 100 mm
8	1	Y 390.05	Wire Basket 250 x 245 x 50 mm



1



2



3



4



5



6



7



8



9



10



11



12



13



14



15



16



17



18



19



20



21



22



23



24



25



26



27



28

1	1	M 219.01	Joseph Raspatorie 16 cm
2	1	M 240.01	Adson Raspatorie 8 mm 17 cm
3	1	M 241.01	Adson Raspatorie 7 mm 17 cm
4	1	M 242.01	Adson Raspatorie 7 mm 17 cm
5	1	M 243.01	Adson Raspatorie 7 mm 17 cm
6	2	M 401.00	Buck - Gramcko Bone Lever 16 cm
7	2	M 402.00	Bone Lever 15 cm
8	2	M 405.00	Bone Lever 15 cm
9	1	M 615.01	Partsch Chisel 4 mm 14 cm
10	1	M 615.02	Partsch Chisel 6 mm 14 cm
11	1	M 615.03	Partsch Chisel 8 mm 14 cm
12	1	M 615.04	Partsch Chisel 10 mm 14 cm
13	1	M 615.05	Partsch Chisel 12 mm 14 cm
14	1	M 620.01	Partsch Gouge 3 mm 14 cm
15	1	M 620.02	Partsch Gouge 4 mm 14 cm
16	1	M 620.03	Partsch Gouge 5 mm 14 cm
17	1	M 620.04	Partsch Gouge 6 mm 14 cm
18	1	M 812.01	Hajek Impactor 22 cm
19	1	N 180.01	Williger Bone Curette 17 cm
20	1	N 326.01	Fomon Raspatorie 21 cm
21	1	P 100.00	Bone Holding Forcep9.5 cm
22	1	P 102.00	Bone Holding Forcep13.5 cm
23	1	P 107.01	Bone Holding Forcep20 cm
24	1	P 142.00	Bone Holding Forcep
25	1	P 300.01	Bohler Bone Rongeur
26	1	P 368.00	Mc Indoe Bone Cutting Forcep
27	1	Y 310.15	Container 285 x 280 x150 mm
28	2	Y 390.05	Wire Basket 250 x 245 x 50 mm

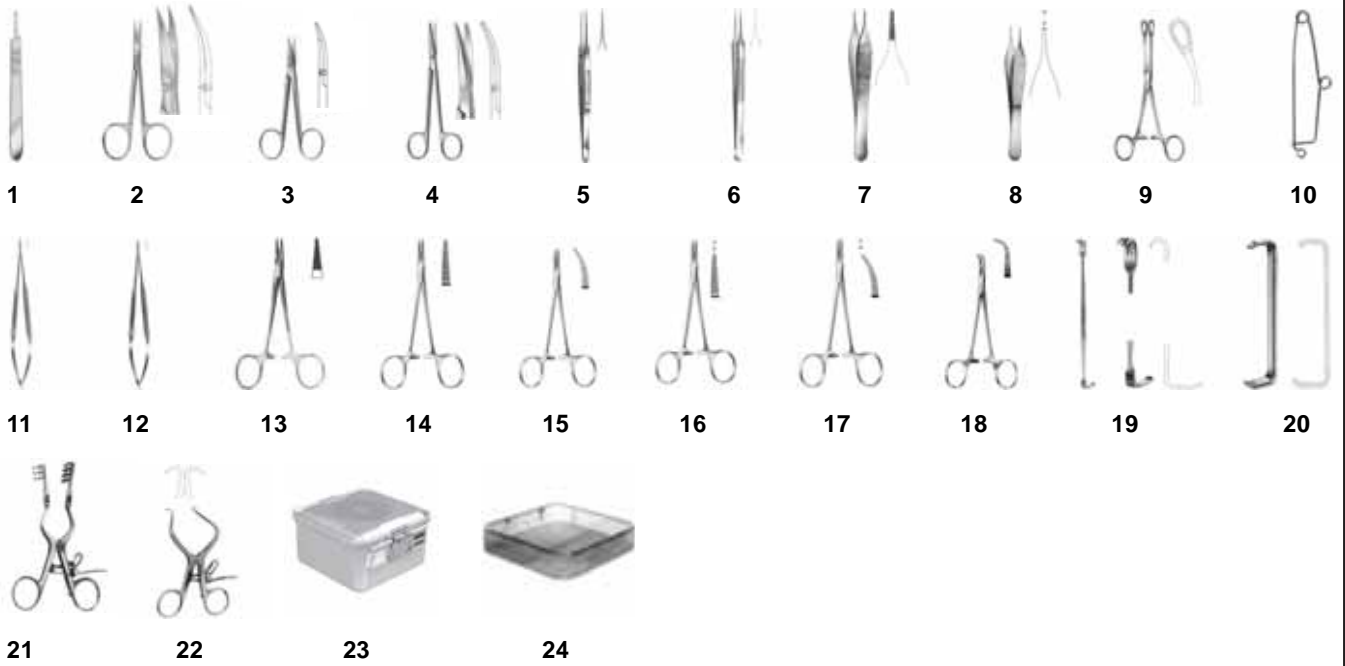

1	1	B 030.01	Scalpel Handle 3 No 12 cm
2	1	C 223.00	Scissors Curved 9.5 cm
3	1	C 391.00	Stevens Scissors Curved 10.5 cm
4	1	C 421.00	Metzenbaum Scissors Curved 16 cm
5	1	D 126.00	Lazar Micro Forcep Uc 0.5 mm 15 cm
6	1	D 128.00	Lazar Micro Forcep Uc 0.8 mm 15 cm
7	1	D 205.00	Adson Forcep Straight 12 cm
8	1	D 323.00	Adson Forcep Teeth 12 cm
9	2	E 083.00	Foerster - Ballanger Dressing Forcep 18 cm
10	1	E 481.00	Mayo Safety Pin 14 cm
11	1	F 132.00	Micro Needle Holder 18 cm
12	1	F 133.00	Micro Needle Holder 18 cm
13	1	F 325.00	Halsey Needle Holder 13 cm
14	2	G 214.00	Halsted - Mosquito Forcep Straight 12.5 cm
15	4	G 215.00	Halsted - Mosquito Forcep Curved 12.5 cm
16	2	G 218.00	Halsted - Mosquito Forcep Straight Teeth 12.5 cm
17	4	G 219.00	Halsted - Mosquito Forcep Curved Teeth 12.5 cm
18	1	G 617.00	Baby - Adson Dissecting Forcep 14 cm
19	2	K 242.00	Senn - Miller Retractor 17 cm
20	1	K 310.00	Farabeuf Retractor 13 cm
21	2	L 330.02	Adson - Baby Self-Retaining Retractor 14 cm
22	2	L 405.00	De Bakey Self-Retaining Retractor 12 cm
23	1	Y 310.10	Container 285 x 280 x 100 mm
24	2	Y 390.07	Wire Basket 255 x 245 x 70 mm



1



2



3



4



5

1	1	M 818.01	Bergman Mallet 23 cm
2	1	T 670.00	Blount Inserter 20 cm
3	1	T 671.01	Blount Extractor 19 cm
4	1	T 673.00	Extractor 20 cm
5	1	Y 410.07	Container 300 x 135 x 70 mm



1	2	K 408.00	Volkman Bone Retractor, Sharp, 24.5 cm
2	2	K 608.02	Kocher - Wagner Retractor, 64x25 mm 28 cm
3	2	M 427.01	Bone Lever, 32 cm
4	2	M 429.02	Bone Lever, 32 cm
5	1	M 434.01	Femoral Retractor, 38 cm
6	1	M 720.05	Chisel, Straight, 26 cm
7	1	M 721.04	Chisel, Curved, 26 cm
8	1	M 735.02	Gouge, 16 mm, 26 cm
9	1	N 600.00	Curette, 37 mm, 25 cm
10	1	N 605.00	Curette, 30 cm
11	1	N 608.00	Curette, 34 cm
12	1	T 700.00	Guide, 50 cm
13	1	T 700.02	Metal Head, 22 cm
14	1	T 700.03	Metal Head, 28 cm
15	1	T 700.04	Metal Head, 32 cm
16	1	T 700.06	Teflon Head, 22 cm
17	1	T 700.07	Teflon Head, 28 cm
18	1	T 700.08	Teflon Head, 32 cm
19	1	T 702.00	Pusher, 14 cm
20	1	T 705.00	Pusher, 20 cm
21	1	T 710.00	Austin Graft Al1c1, 21 cm
22	1	T 711.00	Extractor, 25 cm
23	1	T 714.00	More Prostheses Extractor, 50 cm
24	1	V 730.00	" T " Guide Handle, 21 cm
25	1	V 730.01	Reamer Handle, 23 cm
26	1	V 730.09	Acetabulum Reamer, 44 mm
27	1	V 730.10	Acetabulum Reamer, 46 mm
28	1	V 730.11	Acetabulum Reamer, 48 mm
29	1	V 730.12	Acetabulum Reamer, 50 mm
30	1	V 730.13	Acetabulum Reamer, 52 mm
31	1	V 730.14	Acetabulum Reamer, 56 mm
32	1	Y 110.15	Container, 580 x 280 x 150 mm
33	2	Y 191.05	Wire Basket, 540 x 250 x 50 mm



1

2

3



4



5



6



7



8



9



10



11



12



13



Myringotomy Set

No	Quantity	Code	Description
1	1	A 252.01	Toynbee Ear speculum, 4.0 mm
2	1	A 252.02	Toynbee Ear speculum, 5.5 mm
3	1	A 252.03	Toynbee Ear speculum, 7.0 mm
4	1	B 220.00	Politzer Knife, 16 cm
5	1	J 236.00	Suction canulla, handle, luer cone
6	1	J 236.02	Suction canulla, luer cone, 0.7 mm
7	1	J 236.03	Suction canulla, luer cone, 1.0 mm
8	1	J 236.04	Suction canulla, luer cone, 2.0 mm
9	1	K 057.02	Shea Hook, 17.5 cm
10	1	N 354.02	Buck Ear curette, curved, 2.5 mm, 15 cm
11	1	R 227.00	Hartman-Wullstein Ear forceps 8 cm
12	1	Y 410.04	Mini container 300 X 140 X 40 mm
13	1	Y 850.00	Silicon mat 270 X 125 mm

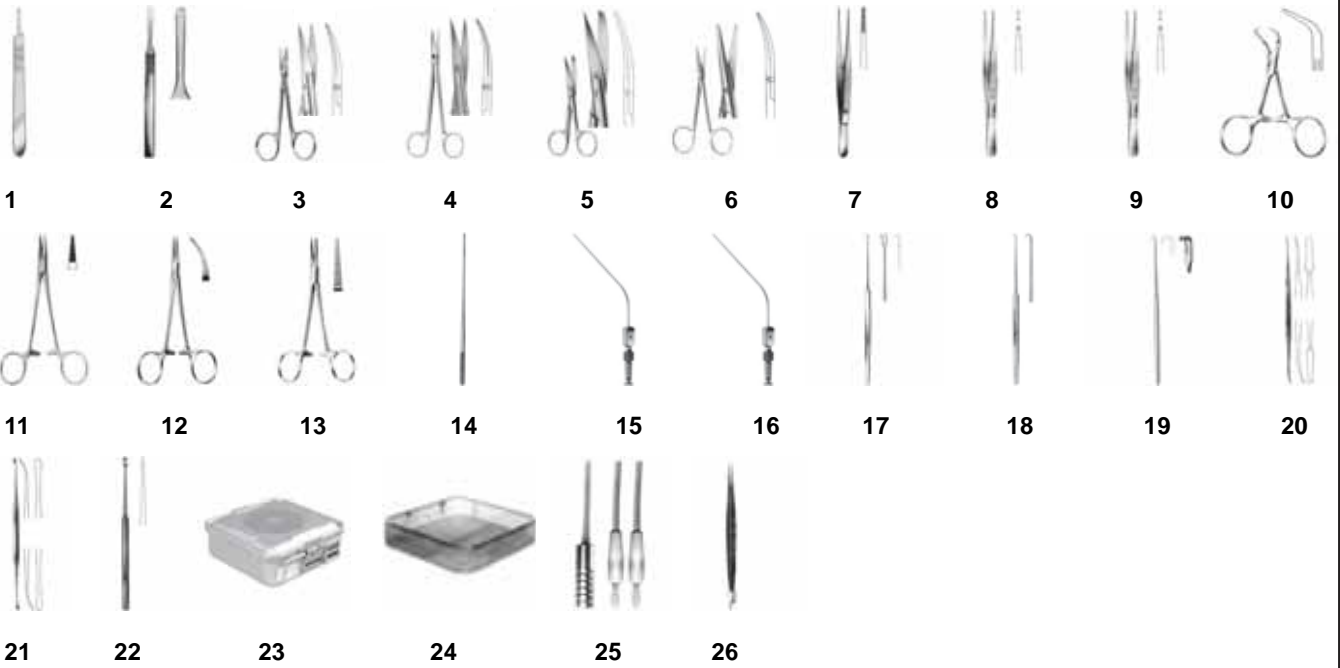

No	Quantity	Code	Description
1	1	B 030.01	Scalpel Handle, No3, 13.5 cm
2	1	B 231.00	Cottle Knife, round 14 cm
3	1	C 231.00	Scissors delicate, curved, 11 cm
4	1	C 251.00	Joseph Scissors, curved, 14 cm
5	1	C 311.03	Scissors, curved, 14.5 cm
6	1	C 411.00	CottleKnapp Scissors, curved, 10.5 cm
7	1	D 218.01	Dissecting Forceps, 15 cm
8	1	D 361.00	Tissue Forceps, delicate, 11.5 cm
9	1	D 361.02	Tissue Forceps, delicate, 14.5 cm
10	6	E 430.01	Backhaus Towel Clamp, 11 cm
11	1	F 328.00	Baby-Crille-Wood Needle Holder, 15 cm
12	6	G 207.00	Micro-Halsted Forceps, curved, 12.5 cm
13	1	G 220.00	Baby-Crille Forceps, straight, 14 cm
14	1	J 056.01	Lathbury-Farrel Triangular serrated, 14 cm
15	1	J 214.00	Fergusson Suction Tube, with luer hub, Ø 2.0 mm, 18 cm
16	1	J 214.01	Fergusson Suction Tube, with luer hub, Ø 2.5 mm, 18 cm
17	1	K 128.00	Freer Hook, 15 cm
18	1	K 134.00	Cottle Hook, 16 cm
19	1	K 169.01	Retractor, 2 prongs, blunt, 16.5 cm
20	1	M 160.01	Killian Elevator, 18.5 cm
21	1	M 161.01	Freer Elevator, 18.5 cm
22	1	M 605.00	Freer Elevator, 16 cm
23	1	Y 310.10	1/2 Size Container, 285 x 280 x 100 mm
24	1	Y 390.07	Wire Baskets, 255 x 245 x 70 mm
25	1	Z 065.00	Bipolar Cord, 2 mt.
26	1	Z 150.01	Bipolar Forceps, insulated, 16 cm

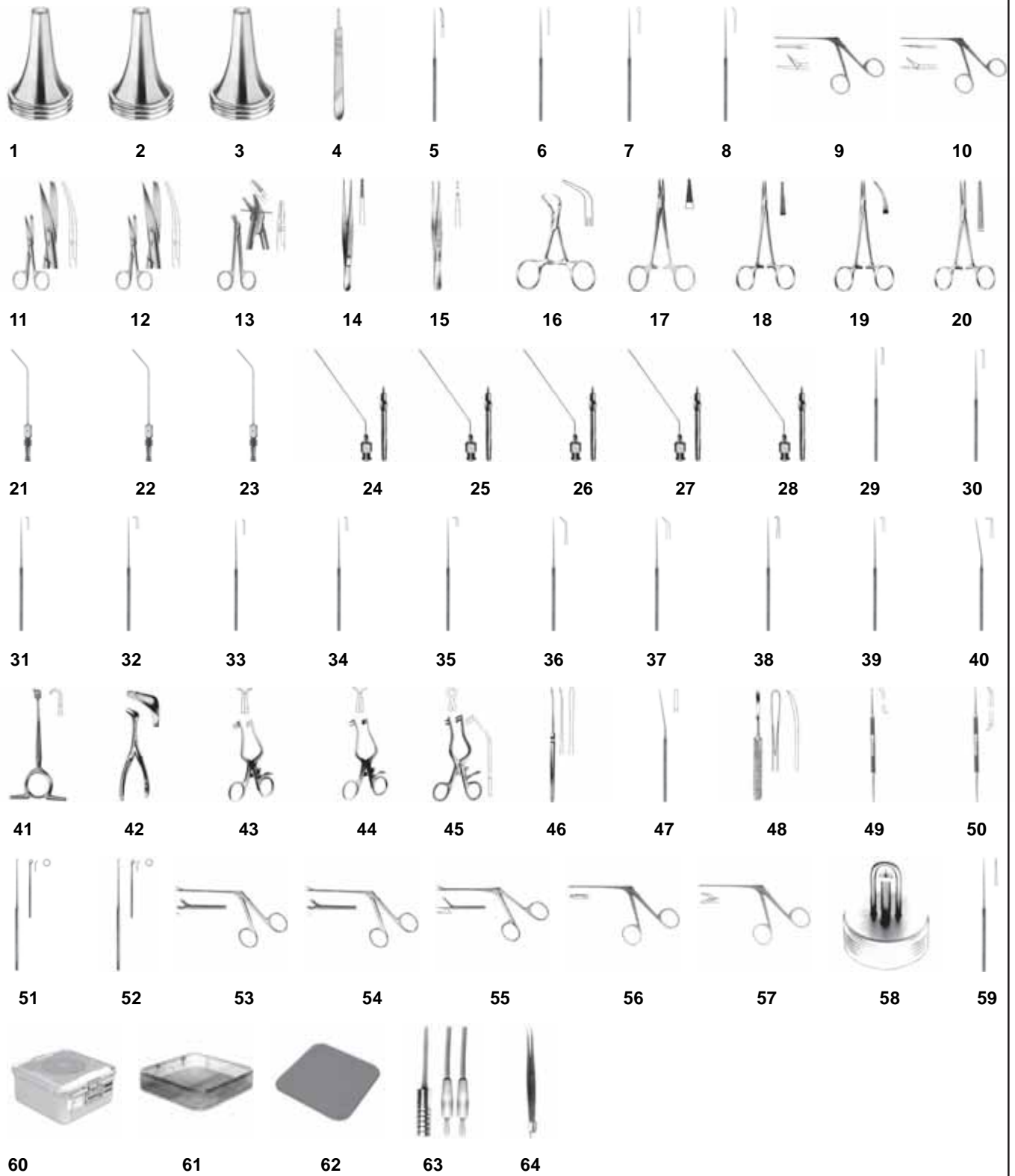

No	Qty	Code	Description	No	Qty	Code	Description
1	1	A 252.01	Tynbe Ear Speculum, Ø 4.0 mm	61	2	Y 390.05	Wire Baskets, 255 x 245 x 50 mm
2	1	A 252.02	Tynbe Ear Speculum, Ø 5.5 mm	62	1	Y 851.00	Silicon Mat, 245 x 245 mm
3	1	A 252.03	Tynbe Ear Speculum, Ø 7.0 mm	63	1	Z 065.00	Bipolar Cord, 2 mt.
4	2	B 030.01	Scalpel Handle, 3 No, 13.5 cm	64	1	Z 172.01	Bipolar Forceps, insulated, 18.5 cm
5	1	B 080.34	Ronis Ear Knife 15 cm				
6	2	B 080.42	Ear Knife, 16 cm				
7	2	B 080.46	Plester Ear Knife, 16 cm				
8	2	B 080.50	Ear Knife, 16 cm				
9	1	C 080.16	Shea Ear Scissors, 8 cm				
10	1	C 080.17	Richards Ear Scissors, 8 cm				
11	1	C 311.02	Surgical Scissors, Curved, 13 cm				
12	1	C 311.03	Surgical Scissors, Curved, 14.5 cm				
13	1	C 668.00	Wire Scissors, serrated, 12 cm				
14	1	D 218.01	Semken Forceps, 15 cm				
15	1	D 361.01	Tissue Forceps 13 cm				
16	6	E 430.00	Backhaus Towel Clamps, 9 cm				
17	1	F 325.00	Halsey Needle Holder, 13 cm				
18	1	G 206.00	Micro-Halsted Haemostatic forceps, straight, 12.5 cm				
19	2	G 207.00	Micro-Halsted Haemostatic forceps, curved, 12.5 cm				
20	1	G 240.00	Crille Haemostatic Forceps, straight, 14 cm				
21	1	J 212.00	Plester Suction Tube, with luer hub, Ø 1.5 mm, 19.5 cm				
22	1	J 212.01	Plester Suction Tube, with luer hub, Ø 2.0 mm, 19.5 cm				
23	1	J 212.02	Plester Suction Tube, with luer hub, Ø 2.5 mm, 19.5 cm				
24	1	J 236.00	Suction Tube, handle				
25	4	J 236.01	Suction Tube, with luer cone, Ø 0.5 mm				
26	4	J 236.02	Suction Tube, with luer cone, Ø 0.7 mm				
27	4	J 236.03	Suction Tube, with luer cone, Ø 1.0 mm				
28	4	J 236.04	Suction Tube, with luer cone, Ø 1.3 mm				
29	1	K 050.03	Austin Ear Pick 16.5 cm, 0.3 mm				
30	1	K 050.05	Austin Ear Pick, 0.7 mm, 16.5 cm				
31	1	K 050.09	Ronis Ear Pick, 0.8 mm, 15 cm				
32	1	K 050.10	Scheer Ear Pick, 1.0 mm, 16 cm				
33	1	K 050.19	Ronis Ear Pick, 45°, 15 cm				
34	1	K 050.24	Scheer Ear Pick, 0.6 mm 16 cm				
35	1	K 050.26	Goldman Ear Pick 15 cm				
36	1	K 050.28	Austin Ear Pick, 16.5 cm				
37	1	K 057.01	Shea Ear Hook 45° 17.5 cm				
38	2	K 057.07	House Type Ear Hook 16.5 cm				
39	2	K 057.09	Scheer Ear Hook 16 cm				
40	1	K 058.08	Schuknecht Ear Hook, 90°, 15.5 cm				
41	1	K 238.00	Williger Retractor, sharp, 12 cm				
42	1	L 266.01	Hartman-Halle Speculum 15.5 cm				
43	1	L 335.00	Plester Self-Retaining Retractor, blunt left, 11 cm				
44	1	L 336.00	Plester Self-Retaining Retractor, blunt right, 11 cm				
45	2	L 339.00	Plester Self-Retaining Retractor, blunt, 13 cm				
46	2	M 150.01	Halle Elevator, blunt, 3.3 mm 18 cm				
47	1	M 071.01	Schuknecht Ear Spatula 15.5 cm				
48	1	M 216.00	Williger Raspatory 6 mm, 16 cm				
49	2	N 056.01	Richards Ear Curette 18 cm				
50	2	N 056.03	House-Type Ear Curette 16 cm				
51	1	N 353.01	Buck Ear Hook 2.0 mm 15 cm				
52	1	N 353.02	Buck Ear Hook 2.5 mm 15 cm				
53	1	R 224.00	Hartmann-Wullstein Forceps, Ø 1 mm				
54	1	R 224.01	Hartmann-Wullstein Forceps, Ø 2 mm				
55	1	R 227.00	Hartmann-Wullstein Forceps, 0.8x6 mm				
56	1	P 050.02	Malleus Ear Forceps, 7 cm				
57	1	P 051.01	McGee Ear Forceps, 7 cm				
58	1	T 202.00	Schuknecht Vein Press				
59	1	V 051.05	Ear Perforator, 1 mm, 16 cm				
60	1	Y 310.13	1/2 Size Container 285x280x135 mm				

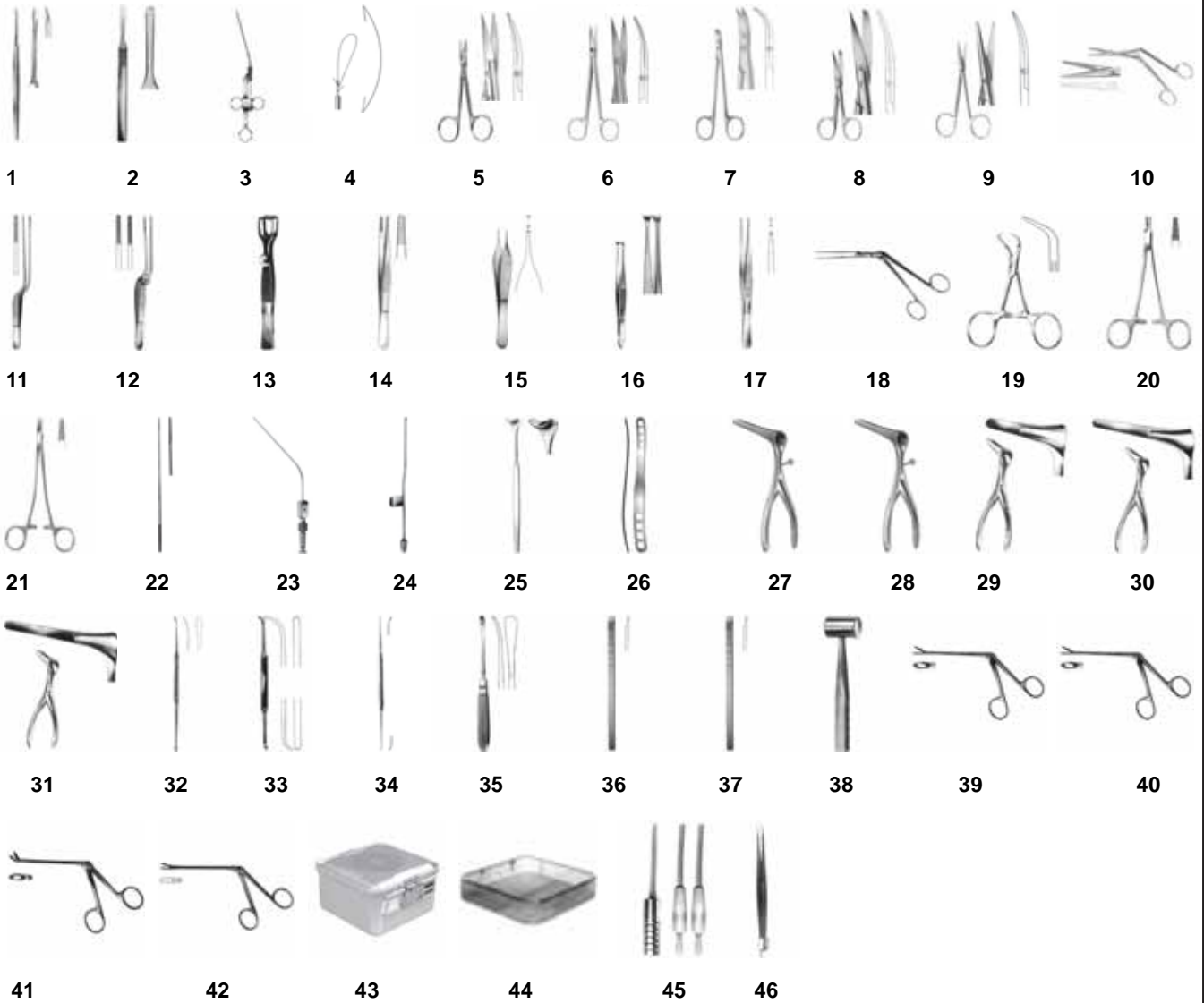

No	Quantity	Code	Description
1	1	B 130.00	Masing Nasal Knife 13 cm
2	1	B 231.00	Cottle Knife, 14 cm
3	1	B 557.00	Krause Polypus Snare, 25 cm
4	1	B 583.00	Snare wire, package of 12 pcs
5	1	C 231.00	Delicate Scissors, curved 11 cm
6	1	C 251.00	Joseph Delicate Scissors, curved 15 cm
7	1	C 260.00	Chadwick Scissors, 11.5 cm
8	1	C 311.03	Scissors, curved, 14.5 cm
9	1	C 411.00	Cottle-Knapp Scissors, Curved 10.5 cm
10	1	C 560.00	Heymann-Knight Nasal Scissors, 17.5 cm
11	1	D 148.00	Jansen Forceps, bayonet-shaped 16 cm
12	1	D 150.00	Cottle Forceps, bayonet-shaped 14 cm
13	1	D 151.01	Cottle Columella Clamp, 10 cm
14	1	D 240.00	Standart Forceps, 11.5 cm
15	1	D 323.00	Adson Tissue Forceps, 12 cm
16	1	D 351.00	Graefe Tissue Forceps, 11 cm
17	1	D 361.00	Tissue Forceps, 11.5 cm
18	1	E 285.00	Lubet-Barbon Dressing Forceps 20 cm
19	6	E 430.01	Backhaus Towel Clamp, 11 cm
20	1	F 333.00	Crile-Wood Needle Holder, 14.5 cm
21	1	F 338.00	Sarot Needle Holder, 17.5 cm
22	2	J 056.02	Lathbury-Farrel Cotton Applicator, triangular serrated, 16 cm
23	1	J 214.02	Fergusson Suction Tube, with luer hub, Ø 3.0 mm, 18 cm
24	1	J 360.00	Canulla, sharp, 4 mm, 20 cm
25	1	K 261.00	Cottle Retractor, 14 cm
26	1	K 583.00	Brünings Tongue Depressor, 19 cm
27	1	L 276.00	Cottle Nasal Speculum 35 x 7 mm, 13.5 cm
28	1	L 276.01	Cottle Nasal Speculum 55 x 7 mm, 13.5 cm
29	1	L 277.01	Cottle Nasal Speculum 55 x 7 mm, 13.5 cm
30	1	L 277.02	Cottle Nasal Speculum 76 x 7 mm, 13.5 cm
31	1	L 277.03	Cottle Nasal Speculum 90 x 7 mm, 13.5 cm
32	1	M 152.01	Freer Elevator, sharp, 19 cm
33	1	M 193.01	Cottle Elevator, sharp, 20 cm
34	1	M 196.01	Cottle Elevator, sharp, 20 cm
35	1	M 232.01	Cottle Elevator, 19.5 cm
36	1	M 631.01	Cottle Chisel 4 mm, 18 cm
37	1	M 631.02	Cottle Chisel 7 mm, 18 cm
38	1	M 815.01	Cottle Metal Mallet 240 gr 18.5 cm
39	1	R 360.01	Weil-Blakesley Ronguer, straight 3.6 mm, 12 cm
40	1	R 360.03	Weil-Blakesley Ronguer, straight 4.8 mm, 12 cm
41	1	R 362.00	Weil-Blakesley Ronguer, curved upwards, 3.6 mm, 11 cm
42	1	R 365.00	Takahashi Ronguer, straight, 12 cm
43	1	Y 310.15	1/2 Size Container, 285 x 280 x 150 mm
44	2	Y 390.05	Wire Baskets 255 x 245 x 50 mm
45	1	Z 065.00	Bipolar cord 2 mt.
46	1	Z 172.01	Bipolar Forceps, insulated, 0.9 mm, 18.5cm

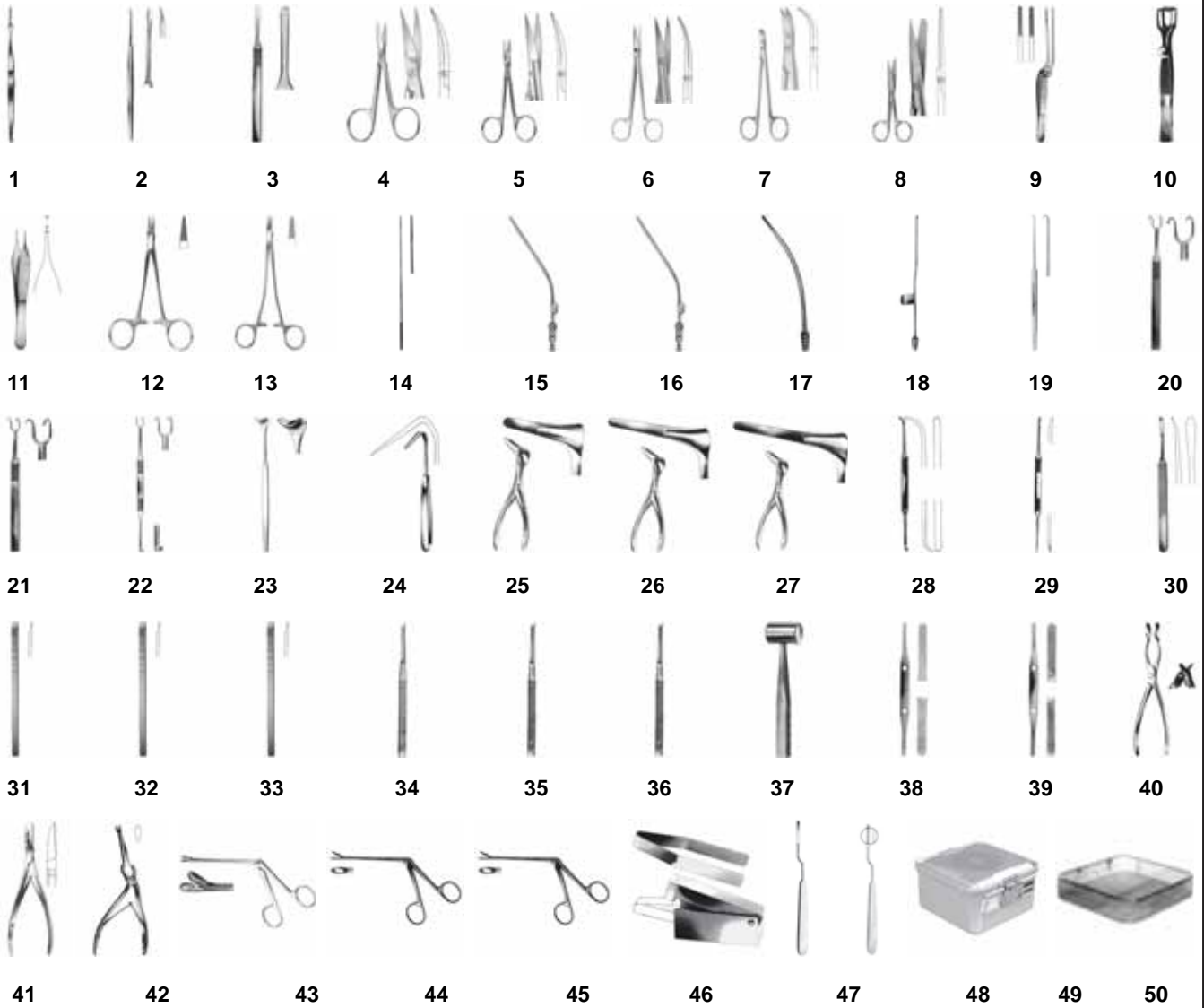

No	Quantity	Code	Description
1	1	B 033.00	Scalpel Handle, 3 No, 16 cm
2	1	B 130.00	Masing Nasal Knife, 13 cm
3	1	B 231.00	Cottle Nasal Knife, 14 cm
4	1	C 221.00	Delicate Scissors, curved, 9 cm
5	1	C 231.00	Delicate Scissors, curved, 11 cm
6	1	C 251.00	Joseph Delicate Scissors, curved, 15 cm
7	1	C 260.00	Chadwick Delicate scissors, curved, 11.5 cm
8	1	C 310.02	Scissors, straight, 13 cm
9	1	D 150.00	Cottle Forceps, bayonet-shaped, 14 cm
10	1	D 151.01	Cottle Camella Clamp, 10 cm
11	1	D 323.00	Adson Tissue Forceps, 12 cm
12	1	F 326.00	Converse Needle Holder, 13 cm
13	1	F 338.00	Sarot Needle Holder, 17.5 cm
14	3	J 056.02	Labhury-Farrel Cotton Applicators, triangular serrated
15	1	J 222.00	Frazier Suction Tube, with luer hub, Ø 3 mm, 18 cm
16	1	J 222.01	Frazier Suction Tube, with luer hub, Ø 5 mm, 18 cm
17	1	J 352.00	Suction Tube, with luer hub, 18 cm
18	1	J 360.00	Canulla, sharp, 4 mm, 20 cm
19	1	K 134.00	Cottle Hook, 16 cm
20	1	K 212.00	Cottle Retractor, Right sharp, 14.5 cm
21	1	K 214.00	Cottle Retractor, left sharp, 14.5 cm
22	1	K 215.00	Cottle Retractor, blunt, 20 cm
23	1	K 261.00	Cottle Retractor, 14 cm
24	1	K 271.00	Aufricht Retractor, 16 cm
25	1	L 277.01	Cottle Nasal Speculum 55 x 7 mm, 13.5 cm
26	1	L 277.02	Cottle Nasal Speculum 76 x 7 mm, 13.5 cm
27	1	L 277.03	Cottle Nasal Speculum 90 x 7 mm, 13.5 cm
28	1	M 193.01	Cottle Elevator, 20 cm
29	1	M 195.01	Masing Elevator, 20 cm
30	1	M 214.00	Konig Raspatory, 5 mm, 15.5 cm
31	1	M 631.01	Cottle Chýsel, 4 mm, 18 cm
32	1	M 631.02	Cottle Chýsel, 7 mm, 18 cm
33	1	M 631.03	Cottle Chýsel, 9 mm, 18 cm
34	1	M 642.00	Masing Chisel, straight, 17.5 cm
35	1	M 642.01	Masing Chisel, Right curved, 17.5 cm
36	1	M 642.02	Masing Chisel, left curved, 17.5 cm
37	1	M 815.01	Cottle Metal Mallet, 240 gr. 18.5 cm
38	1	N 325.01	Fomon Raspatory, 21.5 cm
39	1	N 326.01	Fomon Raspatory, 21.5 cm
40	1	P 200.00	Cottle-Walsham Septum Forceps, 22 cm
41	1	P 355.00	Kazanjian Bone Ronguer, 18.5 cm
42	1	P 581.00	Jansen-Middleton Septum Bone Lever, 21 cm
43	1	R 343.02	Watson-Williams Ronguer, 8 mm, 12 cm
44	1	R 360.01	Weil-Blakesley Ronguer, 3.6 mm, 12 cm
45	1	R 360.03	Weil-Blakesley Ronguer, 4.8 mm, 12 cm
46	1	T 462.00	Bone Crusher
47	1	V 765.01	Joseph Nasal Saw, curved to right, 17 cm
48	1	V 765.02	Joseph Nasal Saw, curved to left, 17 cm
49	1	Y 310.15	1/2 Size Container, 285 x 280 x 150 mm
50	2	Y 390.05	Wire Baskets 255 x 245 x 50 mm

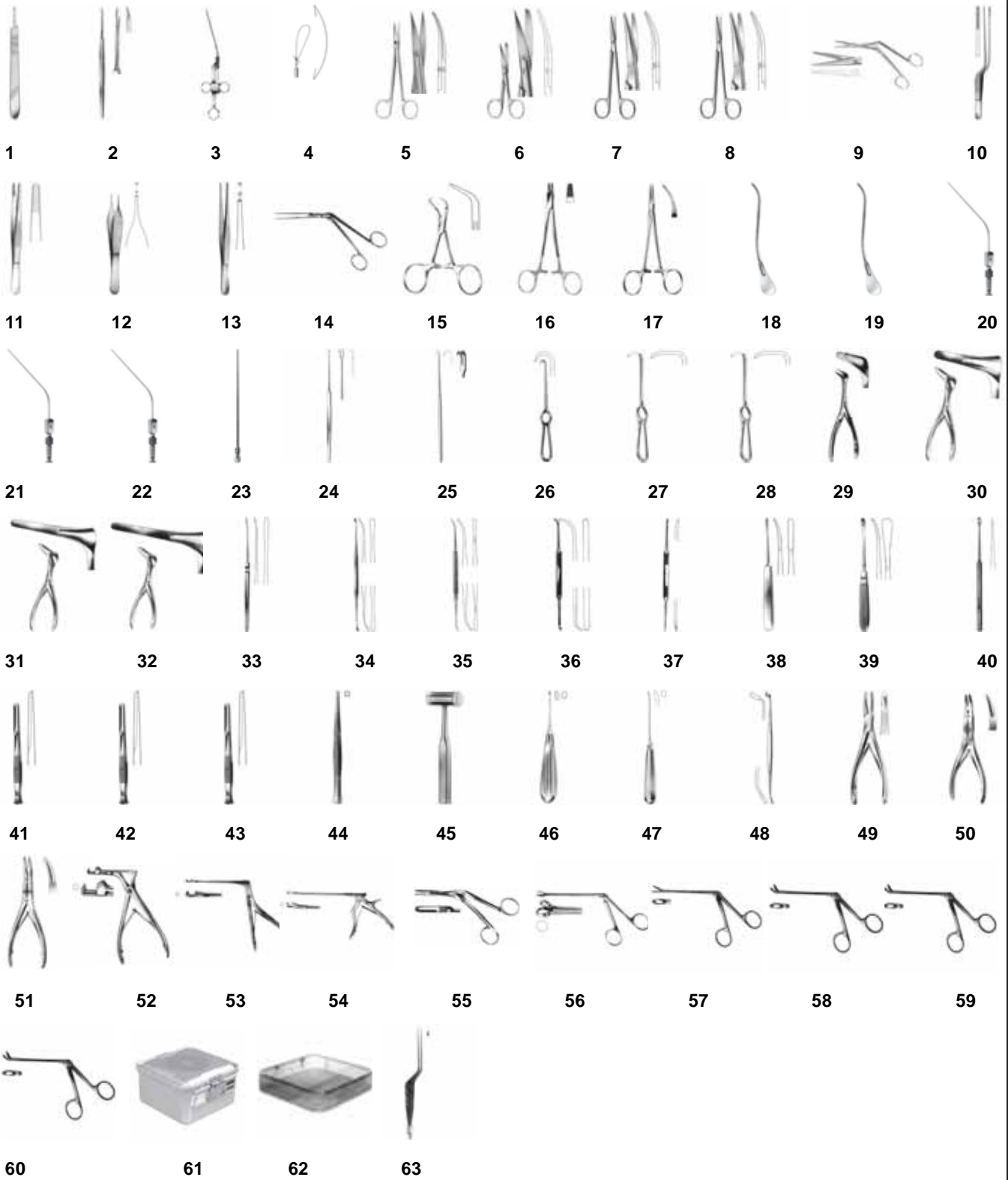

No	Quantity	Code	Description
1	1	B 030.01	Scalpel Handle 3 No, 13.5 cm
2	1	B 130.00	Masing Nasal Knife, curved 13 cm
3	1	B 557.00	Krause Polypus Cutter, 25 cm
4	1	B 583.00	Snare Ware, package of 12 pcsØ 0.3 mm
5	1	C 251.00	Joseph Scissors, curved, 15 cm
6	1	C 311.03	Scissors, Curved, 14.5 cm
7	1	C 421.00	Cottle-Knapp Scissors, curved, 14.5 cm
8	1	C 421.01	Cottle-Knapp Scissors, curved, 18 cm
9	1	C 560.00	Heyman-Khight Nasal Scissors 17.5 cm
10	2	D 148.00	Jansen Forceps 16 cm
11	2	D 240.02	Standart Dissecting Forceps, 14.5 cm
12	1	D 323.00	Adson Tissue Forceps, 12 cm
13	2	D 360.03	Standart Dissecting Forceps, 14.5 cm
14	1	E 285.00	Lubet-Barbon Dressing Forceps 20 cm
15	8	E 430.01	Backhaus Towel Clamps, 11 cm
16	2	F 334.00	Needle Holder, 15 cm
17	6	G 207.00	Micro-Halsted Curved 12.5 cm
18	1	J 026.01	Ritter Probe Ø 2.5 mm, 16 cm
19	1	J 026.02	Ritter Probe Ø 3.0 mm, 16 cm
20	1	J 214.01	Fergusson Suction Tube, with luer hub, Ø 2.5 mm, 18 cm
21	1	J 214.02	Fergusson Suction Tube, with luer hub, Ø 3.0 mm, 18 cm
22	1	J 214.03	Fergusson Suction Tube, with luer hub, Ø 4.0 mm, 18 cm
23	1	J 354.00	Wullstein Suction Tube, with luer hub 16 cm
24	2	K 128.00	Freer Retractor, 15 cm
25	2	K 168.01	Retractor, sharp, 16.5 cm
26	1	K 402.00	Kocher Retractor, sharp, 22 cm
27	2	K 451.03	Langenbeck Retractor 33 x 14 mm, 21 cm
28	2	K 451.06	Langenbeck Retractor 40 x 13 mm, 21 cm
29	1	L 266.01	Hartmann-Halle Nasal Speculum 15.5 cm
30	1	L 277.01	Cottle Nasal Speculum 55 x 7 mm 13.5 cm
31	1	L 277.02	Cottle Nasal Speculum 76 x 7 mm 13.5 cm
32	1	L 277.03	Cottle Nasal Speculum 90 x 7 mm 13.5 cm
33	1	M 150.01	Halle Elevator, 18 cm
34	1	M 161.01	Freer Elevator, 18.5 cm
35	1	M 162.01	Freer-Yasargil Elevator, 18.5 cm
36	1	M 193.01	Cottle Elevator, 20 cm
37	1	M 195.01	Masing Elevator, 20 cm
38	1	M 219.01	Joseph Bone Level, 4 mm, 19 cm
39	1	M 232.01	Cottle Elevator, 19.5 cm
40	1	M 605.00	Freer Chisel 4 mm, 16 cm
41	1	M 621.01	Gouge, 4 mm, 14 cm
42	1	M 621.03	Gouge, 8 mm, 14 cm
43	1	M 621.04	Gouge, 10 mm, 14 cm
44	1	M 751.00	Passow Chisel 2 x 2 mm, 12 cm
45	1	M 801.00	Mallet Plastic Disk, 18.5 cm 140 gr
46	1	N 179.02	Wolkmann Bone Curette, 17 cm
47	1	N 187.02	Halle Antrum Curette, 21.5 cm
48	1	N 372.01	Faulkner Antrum Curette
49	1	P 277.00	Jansen Bone Ronguer, 17.5 cm
50	1	P 300.01	Böhler Bone Ronguer, 15.5 cm
51	1	P 302.00	Beyer Bone Ronguer, 18 cm
52	1	P 400.01	Citelli Punch,6.5 cm
53	1	P 412.00	Hajek-Kofler Punch, 14 cm
54	1	P 415.00	Kofler Punch 14.5 cm
55	1	R 324.00	Craig Ronguer, straight 16.5 cm
56	1	R 347.01	Hartman Ronguers round, 12 cm
57	1	R 360.01	Weil-Blakesley Ronguers, straight, 12 cm
58	1	R 362.00	Weil-Blakesley Ronguers, curved upwards, 11 cm
59	1	R 362.01	Weil-Blakesley Ronguers, curved upwards, 11 cm
60	1	R 362.02	Weil-Blakesley Ronguers, curved upwards, 11 cm
61	1	Y 310.15	1/2 Size Container 285 x 280 x 150
62	1	Y 390.03	Wire Baskets 255 x 245 x 30 mm
63	1	Y 390.07	Wire Baskets 255 x 245 x 70 mm
	1	Z 160.14	Bipolar Forceps, insulated, 1.0 mm, 19.5 cm

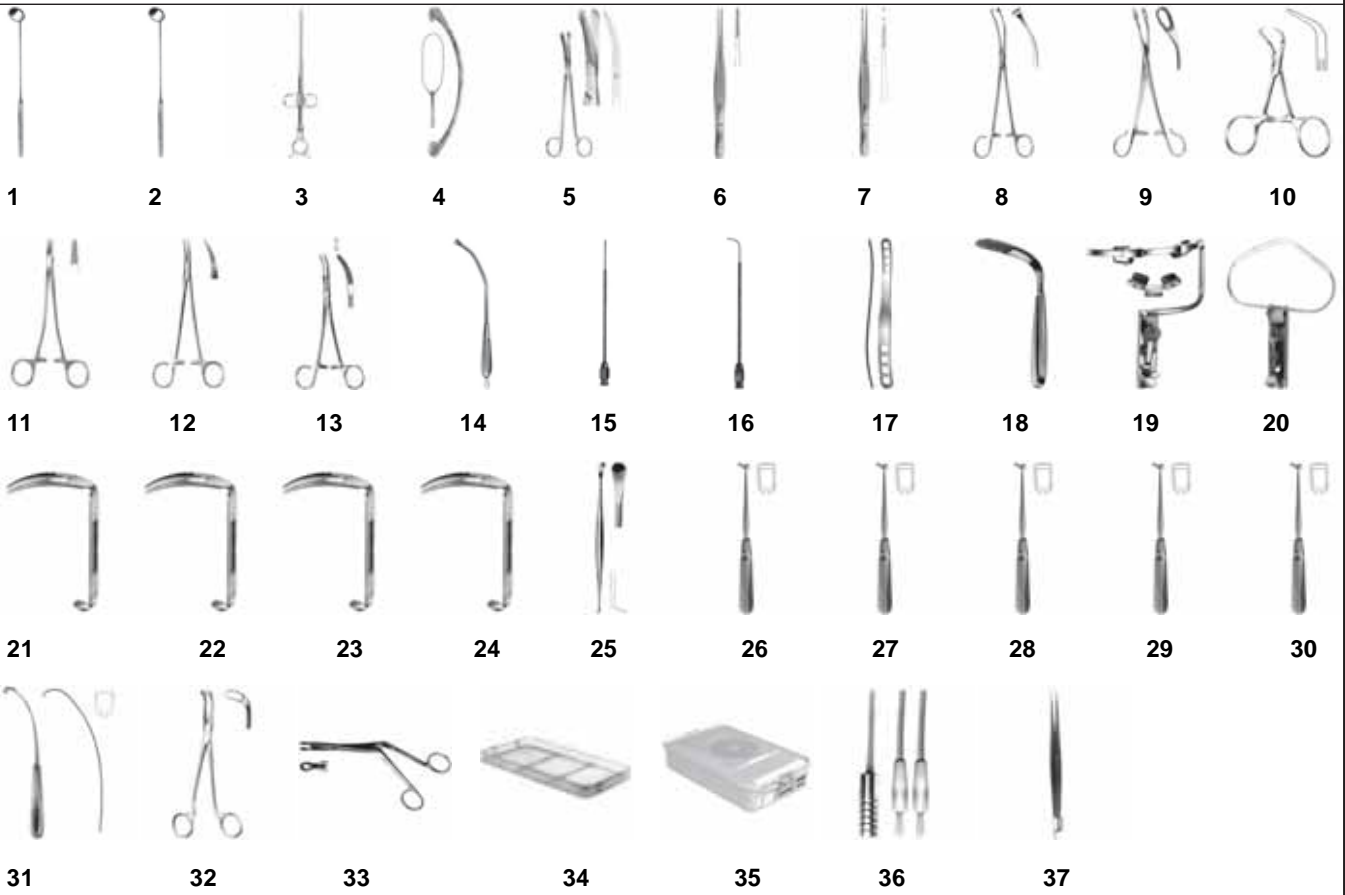

No	Quantity	Code	Description
1	1	A 300.03	Laryngeal Mirror, Ø 10 mm
2	1	A 300.06	Laryngeal Mirror, Ø 16 mm
3	1	B 240.00	Eyes Tonsil Snare, 25 cm
4	1	B 580.01	Wire Snare, Package of 12 pcs, Ø 0.5 mm
5	1	C 554.00	Good Scissors 19.5 cm
6	1	D 220.00	Cushing Dissecting Forceps 18 cm
7	1	D 382.01	Waugh Tissue Forceps, 20 cm
8	1	E 222.00	Marschik-Krone Forceps, 20.5 cm
9	1	E 225.00	Blohmke Forceps, 20.5 cm
10	6	E 430.01	Backhaus Towel Clamp, 11 cm
11	1	F 338.00	Sarot Needle Holder, 17.5 cm
12	1	G 461.00	Schmidt Forceps, curved, 18.5 cm
13	1	G 466.00	Mikulicz Forceps, curved, 18.5 cm
14	1	J 300.00	Yankauer Suction Tube 28.5 cm
15	1	J 725.00	Tonsil Needle, straight
16	1	J 726.00	Tonsil Needle, curved
17	1	K583.00	Brünings Tongue Depressor 19 cm
18	1	K 588.00	Tobold Tongue Depressor, 16 cm
19	1	L 160.00	Davis-Meyer Mouth Gag
20	1	L 165.00	Mclvor Mouth Gag
21	1	L 225.01	Russel-Davis Tongue Blade 29 x 67
22	1	L 225.02	Russel-Davis Tongue Blade 33 x 75
23	1	L 225.03	Russel-Davis Tongue Blade 38 x 85
24	1	L 225.04	Russel-Davis Tongue Blade 40 x 92
25	1	M 208.02	Henkel Dissector, 12 mm wide, 23.5 cm
26	1	N 380.00	Beckmann Adenoid Curette, straight, 20 cm
27	1	N 380.01	Beckmann Adenoid Curette, straight, 20 cm
28	1	N 380.02	Beckmann Adenoid Curette, straight, 20 cm
29	1	N 380.03	Beckmann Adenoid Curette, straight, 20 cm
30	1	N 380.04	Beckmann Adenoid Curette, straight, 20 cm
31	1	N 383.02	Negus Adenoid Curette, 20 cm
32	1	R 280.00	Jurasz Tonsil Forceps, 19 cm
33	1	R 328.03	Brünings Ronguer, round, 19 cm
34	1	Y 290.05	Wire Baskets, 405 x 255 x 50 mm
35	1	Y 210.10	3/4 Size Container, 465 x 280 x 100 mm
36	1	Z 065.00	Bipolar Cord, 2 mt.
37	1	Z 172.01	Bipolar Forceps, insulated, 19 cm

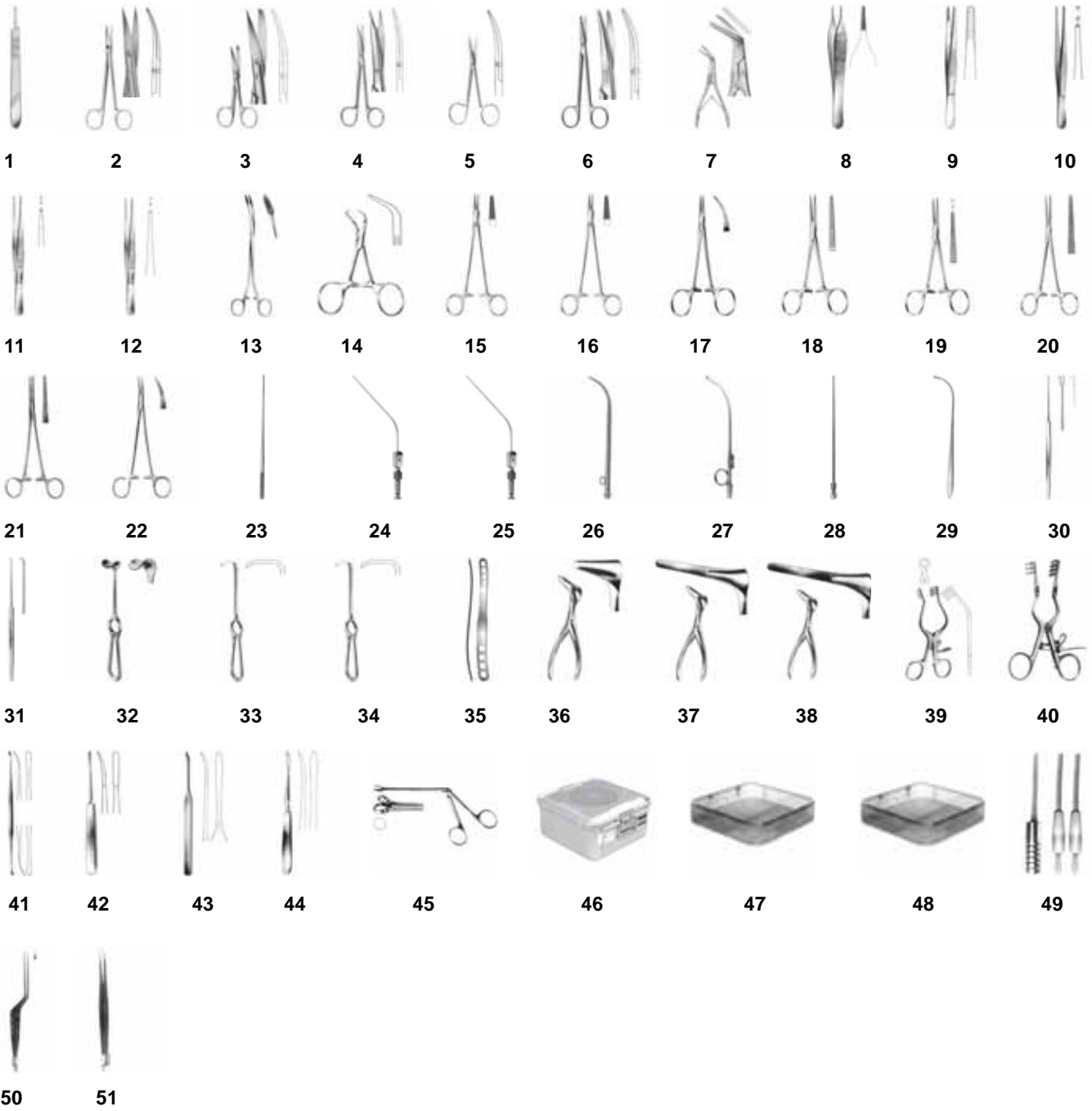

No	Quantity	Code	Description
1	1	B 030.01	Scalpel Handle, 3 No, 13.5 cm
2	1	C 251.00	Joseph Scissors, curved 15 cm
3	1	C 311.03	Scissors, curved, 14.5 cm
4	1	C 387.00	Reynolds Dissecting Scissors, curved, 14.5 cm
5	1	C 411.00	Cottle-Knapp Scissors, curved, blunt, 10.5 cm
6	1	C 421.01	Cottle-Knapp Scissors, 18 cm
7	1	C 695.00	Killian Scissors, both jaws serrated, 20cm
8	1	D 205.00	Adson Forceps, 12 cm
9	1	D 240.03	Standart Forceps, 16 cm
10	2	D 360.03	Standart Tissue Forceps, 14.5 cm
11	1	D 361.02	Tissue Forceps, 14.5 cm
12	1	D 361.03	Tissue Forceps, 16 cm
13	1	E 030.00	Duplay Dressing Forceps, 21 cm
14	6	E 430.01	Backhaus Towel Clamp, 11 cm
15	1	F 355.00	Hegar-Mayo Needle Holder, 15 cm
16	1	F 355.01	Hegar-Mayo Needle Holder, 18 cm
17	8	G 207.00	Micro-Halsted, Curved, 12.5 cm
18	2	G 240.00	Crille Forceps, straight, 14 cm
19	2	G 244.00	Crille Forceps, straight, 14 cm
20	1	G 264.00	Crille Forceps, straight, 16 cm
21	1	G 288.00	Birkett Forceps, straight, 18.5 cm
22	2	G 461.00	Schmidt Forceps, curved, 18.5 cm
23	2	J 056.01	Lathbury-Farrel Cotton Applicator, Triangular serrated, 14 cm
24	1	J 214.00	Fergusson Suction Tube, with luer hub, Ø 2.0 mm, 18 cm
25	1	J 214.02	Fergusson Suction Tube, with luer hub, Ø 3.0 mm, 18 cm
26	1	J 314.02	Siebenmann Canulla, blunt, Ø 2.5 mm, 13 cm
27	1	J 350.01	Canulla, Ø 5.5 mm, 17.5 cm
28	1	J 354.00	Wullstein Suction Tube, with luer hub, 16 cm
29	1	J 381.01	Killian Cotton Carrier, curved, 25 cm
30	1	K 128.00	Freer Hook, 15 cm
31	1	K 134.00	Cottle Hook 16 cm
32	1	K 276.00	Kocher Retractor, 20.5 cm
33	2	K 451.03	Langenbeck Retractor, 33 x 14 mm, 21 cm
34	2	K 451.06	Langenbeck Retractor, 40 x 13 mm, 21 cm
35	1	K 583.00	Brünings Tongue Depressor, 19 cm
36	1	L 277.01	Cottle Nasal Speculum, 55 x 7 mm, 13.5 cm
37	1	L 277.02	Cottle Nasal Speculum, 76 x 7 mm, 13.5 cm
38	1	L 277.03	Cottle Nasal Speculum, 90 x 7 mm, 13.5 cm
39	1	L 326.00	Wullstein Self-Retaining Retractor, blunt, 13 cm
40	1	L 331.02	Adson-Baby Self-Retaining Retractor, blunt, 14 cm
41	1	M 161.01	Freer Elevator, 18.5 cm
42	1	M 219.01	Joseph Elevator, 17 cm
43	1	M 330.01	Konig Elevator, 15.5 cm
44	1	M 340.01	Qervain Elevator, 19.5 cm
45	1	R 347.01	Hartmann Ronguer, 12 cm
46	1	Y 310.13	1/2 Size Container, 285 x 280 x 135 mm
47	1	Y 390.03	Wire Baskets, 255 x 245 x 30 mm
48	1	Y 390.07	Wire Baskets, 255 x 245 x 70 mm
49	1	Z 065.00	Bipolar Cord, 2 mt.
50	1	Z 160.11	Bipolar Forceps, insulated, 1.3 mm, 17.5 cm
51	1	Z 172.01	Bipolar Forceps, insulated, 0.9 mm, 18.5 cm

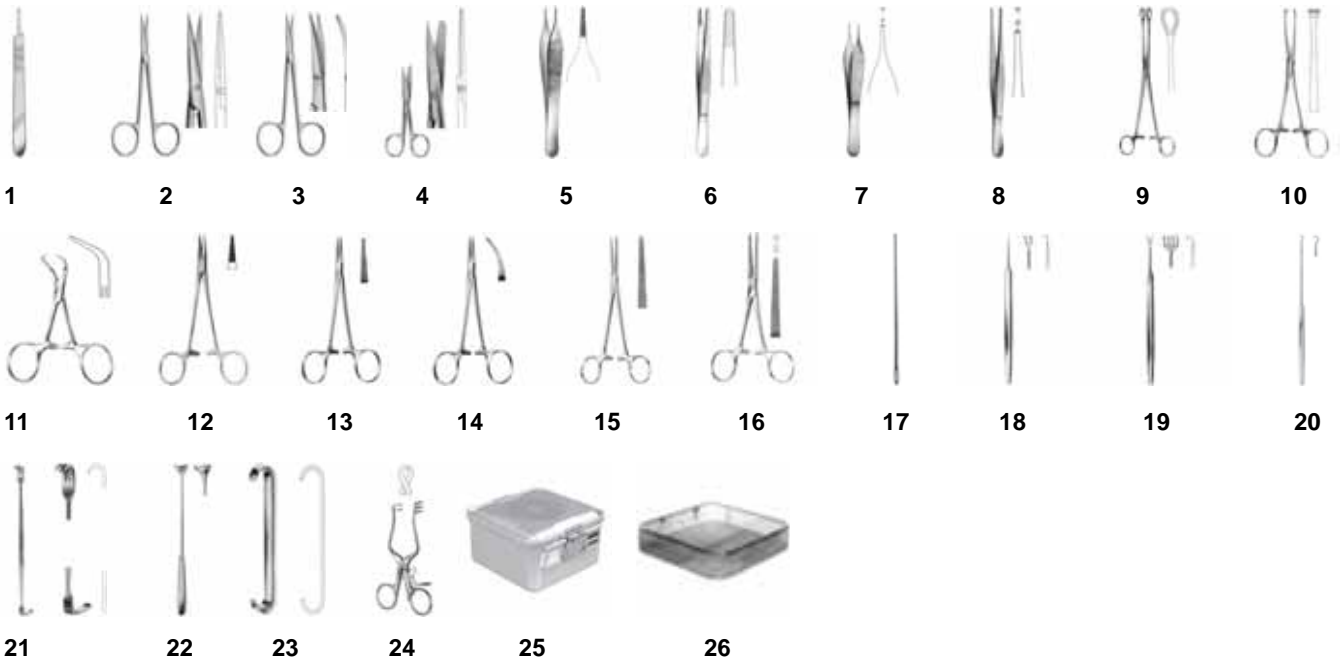

No	Quantity	Code	Description
1	2	B 030.01	Scalpel Handle 3 no, 13.5 cm
2	1	C 224.00	Delicate Scissors, Straight, 11.5 cm
3	1	C 225.00	Delicate Scissors, Curved, 11.5 cm
4	1	C 310.03	Surgical Scissors, Straight, 14.5 cm
5	1	D 205.00	Micro Adson Delicate Dissecting Forcep, 12 cm
6	1	D 240.02	Standart Dissecting Forcep, 14.5 cm
7	1	D 323.00	Adson Delicate Tissue Forcep, 12 cm
8	1	D 360.03	Standart Tissue Forcep, 14.5 cm
9	2	E 086.00	Foerster-Ballenger Organ and Tissue Forcep, Straight, 24 cm
10	6	E 144.00	Allis Tissue Grasping Forcep, 5x6 teeth, 15.5 cm
11	6	E 430.00	Backhaus Towel Clamp, 9 cm
12	1	F 328.00	Baby-Crile-wood Needle Holder, HM, 15 cm
13	12	G 206.00	Micro-Halsted Delicate Haemostatic Forcep, Straight, 12.5 cm
14	6	G 207.00	Micro-Halsted Delicate Haemostatic Forcep, Curved, 12.5 cm
15	6	G 264.00	Crile Delicate Haemostatic Forcep, Straight, 16 cm
16	2	G 438.00	Rochester—Ochsner Haemostatic Forcep, Straight, 14 cm
17	1	J 035.00	Probe, Ø 2.5 mm 14.5 cm
18	2	K 123.00	Guithrie Skin Hook, Sharp, 12.5 cm
19	2	K 124.01	Rollet Skin Hook, Sharp, 13.5 cm
20	2	K 138.00	Gillies Skin Hook, 18 cm
21	2	K 242.00	Senn-Miller Retractor, 18x6 mm 16.5 cm
22	2	K 274.00	Cushing Retractor, 11x14 mm, 25 cm
23	1	K 314.00	Parker Retractor, 13.5 cm
24	1	L 301.00	Weitlaner Self-Retaining Retractor, Blunt, 11 cm
25	1	Y 310.15	1/2 Size Container, 285 x 280 x 150 mm
26	1	Y 390.05	Wire Baskets, 255 x 245 x 50 mm



1



2



3



4



5



6



7



8



9



10



11



12



13



14



15



16



17



18



19



20



21



22

No	Quantity	Code	Description
1	2	B 030.01	Scalpel Handle 3 no, 13.5 cm
2	1	C 224.00	Delicate Scissors, Straight, 11.5 cm
3	1	C 225.00	Delicate Scissors, Curved, 11.5 cm
4	1	C 421.01	Metzenbaum Dissecting Scissors, Curved, 18 cm
5	1	C 442.00	Mayo-Stille Surgical Scissors, Straight, 14 cm
6	1	D 205.00	Micro Adson Delicate Dissecting Forcep, 12 cm
7	1	D 240.02	Standart Dissecting Forcep, 14.5 cm
8	1	D 323.00	Adson Delicate Tissue Forcep, 12 cm
9	1	D 360.03	Standart Tissue Forcep, 14.5 cm
10	2	E 082.00	Foerster-Ballenger Organ and Tissue Forcep, Straight 18 cm
11	4	E 144.00	Allis Tissue Grasping Forcep, 5x6 teeth, 15.5 cm
12	6	E 430.00	Backhaus Towel Clamp, 9 cm
13	1	F 328.00	Baby-Crile-wood Needle Holder, HM, 15 cm
14	6	G 207.00	Micro-Halsted Delicate Haemostatic Forcep, Curved, 12.5 cm
15	2	K 143.00	Joseph Dura Hook, 16.5 cm
16	1	M 161.01	Freer Raspatorie, Sharp/Blunt, 18.5 cm
17	1	M 219.01	Joseph Raspatorie, 4 mm, 17 cm
18	1	N 353.02	Buck Curette, Curved/Sharp, 2.5 mm, 15 cm
19	1	N 353.03	Buck Curette, Curved/Sharp, 3 mm, 15 cm
20	1	N 353.04	Buck Curette, Curved/Sharp, 4 mm, 15 cm
21	1	Y 310.08	Flat Container, 285 x 280 x 85 mm
22	1	Y 390.05	Wire Baskets, 255 x 245 x 50 mm



1 2 3 4 5 6 7 8 9 10



11 12 13 14 15 16 17 18 19 20



21 22 23 24 25 26 27 28 29 30



31 32 33 34 35 36 37 38 39



40



41

No	Quantity	Code	Description
1	1	A 500.01	Instrument for Measuring, 15 cm
2	1	A 510.00	Instrument for Measuring, Measuring 150 mm
3	1	B 030.01	Scalpel Handle 3 no, 13.5 cm
4	1	B 040.00	Scalpel Handle 4 no, 13.5 cm
5	1	B 182.00	Schinic Dermatome 30 cm
6	1	C 251.00	Joseph Delicate Scissors, Curved, Sharp, 15 cm
7	1	C 315.03	Surgical Scissors, Curved, 14.5 cm
8	1	C 366.00	Dissecting Scissors, Curved, 11.5 cm
9	1	C 382.00	Kilner Dissecting Scissors, 12.5 cm
10	1	C 382.01	Kilner Dissecting Scissors, 15 cm
11	2	C 386.00	Jameson Dissecting Scissors, 15 cm
12	1	C 393.00	Stevens Dissecting Scissors, Curved, Blunt, 11 cm
13	1	C 413.00	Baby-Metzenbaum Dissecting Scissors, Curved, 14.5 cm
14	1	C 416.00	Toennis-Adson Dissecting Scissors, Curved, 17.5 cm
15	1	D 205.00	Adson Delicate Dissecting Forcep, 12 cm
16	2	D 323.00	Adson Delicate Tissue Forcep, 12 cm
17	1	E 144.00	Allis Tissue Grasping Forcep, 5x6 teeth, 15.5 cm
18	4	E 430.01	Backhaus Towel Clamp, 11 cm
19	1	F 210.00	Baumgartner Needle Holder, 14.5 cm
20	2	F 219.00	Crile-Murkey Needle Holder, 15 cm
21	1	F 221.00	Kilner Needle Holder, 13.5 cm
22	1	F 325.00	Halsey Needle Holder, HM, 13 cm
23	1	F 355.00	Hegar-Mayo Needle Holder, 15 cm
24	5	G 200.00	Baby-Mosquito Delicate Haemostatic Forcep, Straight, 10 cm
25	5	G 201.00	Baby-Mosquito Delicate Haemostatic Forcep, Curved, 10 cm
26	1	G 440.01	Kocher Haemostatic Forcep, Straight, 13 cm
27	1	K 127.00	Kilner Skin Hook, 16 cm
28	1	K 143.03	Joseph Dura Hook, 16.5 cm
29	1	K 151.00	Converse Skin Hook, Blunt, 12 cm
30	1	K 168.01	Retractor, Small, Sharp, 16.5 cm
31	1	K 177.00	Mannerfelt Retractor, Sharp, 15.5 cm
32	1	K 191.03	Langenbeck-Mannerfelt Retractor, 30 x 8 mm, 15.5 cm
33	1	K 242.00	Senn-Miller Retractor, 18x6 mm 16.5 cm
34	2	K 310.00	Farabeuf Retractor, 12.5 cm
35	1	L 325.00	Wullstein Self-Retaining Retractor, Sharp, 13 cm
36	1	M 160.01	Killian Raspatorie, Sharp/Blunt, 18.5 cm
37	1	M 161.01	Freer Raspatorie, Sharp/Blunt, 18.5 cm
38	1	M 330.01	König Bone Level, 4.5 mm, 15.5 cm
39	1	T 600.00	Langenbeck Nasal Saw, Straight, 23.5 cm
40	1	Y 210.10	3/4 Container, 465 x 280 x 100 mm
41	1	Y 290.03	Wire Baskets, 405 x 255 x 30 mm



No	Quantity	Code	Description
1	1	B 030.02	Scalpel Handle 3 no, 21.5 cm
2	1	C 798.00	Scissors, One Jaw Serrated, 12 cm
3	4	E 430.01	Backhaus Towel Clamp, 11 cm
4	1	F 447.01	Sanders-Brown Awl, 30 cm
5	1	K 350.00	Obwegeser Retractor, 8 mm, 16 cm
6	1	K 351.00	Obwegeser Retractor, 16 cm
7	1	L 155.01	Dingman Mouth Gag, Frame only
8	1	L 228.01	Mclvor Tongue Depressor, 25x55 mm
9	1	L 228.02	Mclvor Tongue Depressor, 25x62 mm
10	1	L 228.03	Mclvor Tongue Depressor, 25x75 mm
11	2	M 216.00	Williger Raspatorie, 6 mm, 16 cm
12	1	M 272.01	Raspatorie, 4 mm, 14 cm
13	1	M 273.01	Raspatorie, 4 mm, 14 cm
14	1	M 615.02	Osteotome 6 mm, 14 cm
15	1	Y 310.10	3/4 Container, 285 x 280 x 100 mm
16	1	Y 390.05	Wire Baskets, 255 x 245 x 50 mm

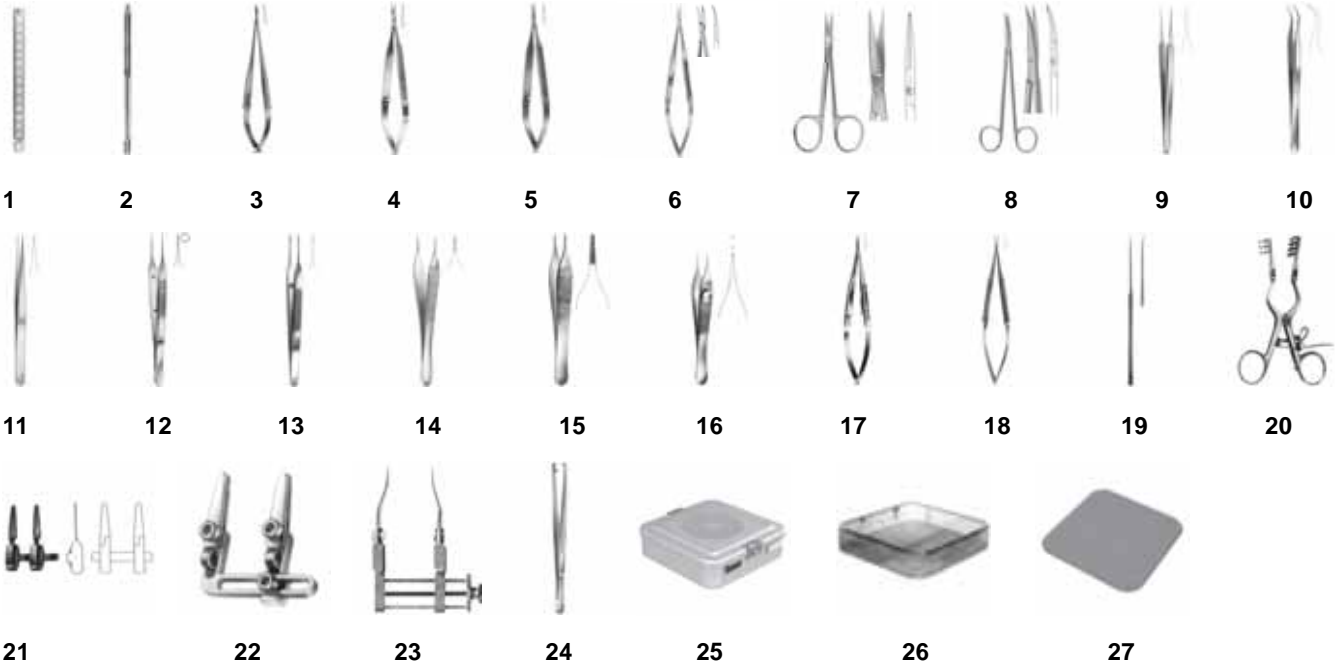

No	Quantity	Code	Description
1	1	A 500.01	Instrument for Measuring, 15 cm
2	1	B 010.00	Scalpel Handle, 13.5 cm
3	2	C 101.00	Micro Scissors, Curved, 10.5 cm
4	1	C 103.00	Micro Scissors, Curved, 12 cm
5	1	C 106.00	Vannas Micro Scissors, Straight, 12 cm
6	1	C 113.00	Micro Scissors, Curved, 16 cm
7	1	C 222.00	Delicate Scissors, Straight, 9.5 cm
8	1	C 258.00	Delicate Scissors Curved, 15 cm
9	1	D 103.00	Micro Suture Tying Forcep, 0.2 mm 11 cm
10	1	D 105.00	Micro Suture Tying Forcep, 0.2 mm 11.5 cm
11	2	D 107.00	Micro Suture Tying Forcep, 0.3 mm 12 cm
12	1	D 124.00	Micro Suture Tying Forcep, 1x2 teeth 0.2 mm 9.5 cm
13	1	D 125.00	Austin Micro Suture Tying Forcep, 0.8 mm 14 cm
14	1	D 204.00	Micro-Adson Delicate Dissecting Forcep, 12 cm
15	1	D 205.00	Adson Delicate Dissecting Forcep, 12 cm
16	1	D 326.00	Adson Delicate Tissue Forcep, 12 cm
17	1	F 121.00	Barraquer Micro Needle Holder, With Catch, 12 cm
18	1	F 127.00	Reill Micro Needle Holder, Without Catch, 15 cm
19	1	K 127.00	Kilner Skin Hook, 16 cm
20	1	L 331.02	Adson-Baby Self-Retaining Retractor, Blunt, 14 cm
21	1	S 013.00	Biemer-Muller Approximator, Jaw 9 mm, Opening 5 mm, Closing Force 25-30 gr
22	1	S 025.00	Approximator complete, with key
23	3	S 030.00	Approximator
24	2	S 035.00	Biemer Vessel Clip, 14.5 cm
25	1	Y 310.08	Flat Container, 285 x 280 x 85 mm
26	1	Y 390.03	Wire Baskets, 255 x 245 x 30 mm
27	1	Y 851.00	Silicon mat 245 X 245 mm





Peritonsillar Abscess Inc And Set

No	Quantity	Code	Description
1	1	B 032.00	Scalpel Handle 3 no, 16.5 cm
2	2	E 082.00	Foerster-Ballenger Organ and Tissue Forcep, Straight 18 cm
3	4	E 430.00	Backhaus Towel Clamp, 9 cm
4	2	G 460.01	Schmidt Haemostatic Forcep, 18.5 cm
5	1	K 589.00	Wieder Tongue Depressor, 14 cm
6	1	K 589.01	Wieder Tongue Depressor, 15 cm
7	1	Y 410.07	Mini Container, 300 x 140 x 70 mm



1



2



3



4



5



6



7



8



Postoperative Emergency Tonsil Set

No	Quantity	Code	Description
1	1	C 442.01	Mayo Stille Surgical Scissors, Straight, 17 cm
2	2	E 082.00	Foerster-Ballenger Organ and Tissue Forcep, Straight 18 cm
3	1	F 346.00	De Bakey Needle Holder, HM, 18 cm
4	6	G 460.01	Schmidt Haemostatic Forcep, 18.5 cm
5	1	J 301.00	Yankauer Suction Tube, Ø 2 mm 28.5 cm
6	1	K 589.01	Wieder Tongue Depressor, 15 cm
7	1	M 205.02	Hurd Raspatorie, 6 mm, 21.5 cm
8	1	Y 410.07	Mini Container, 300 x 140 x 70 mm

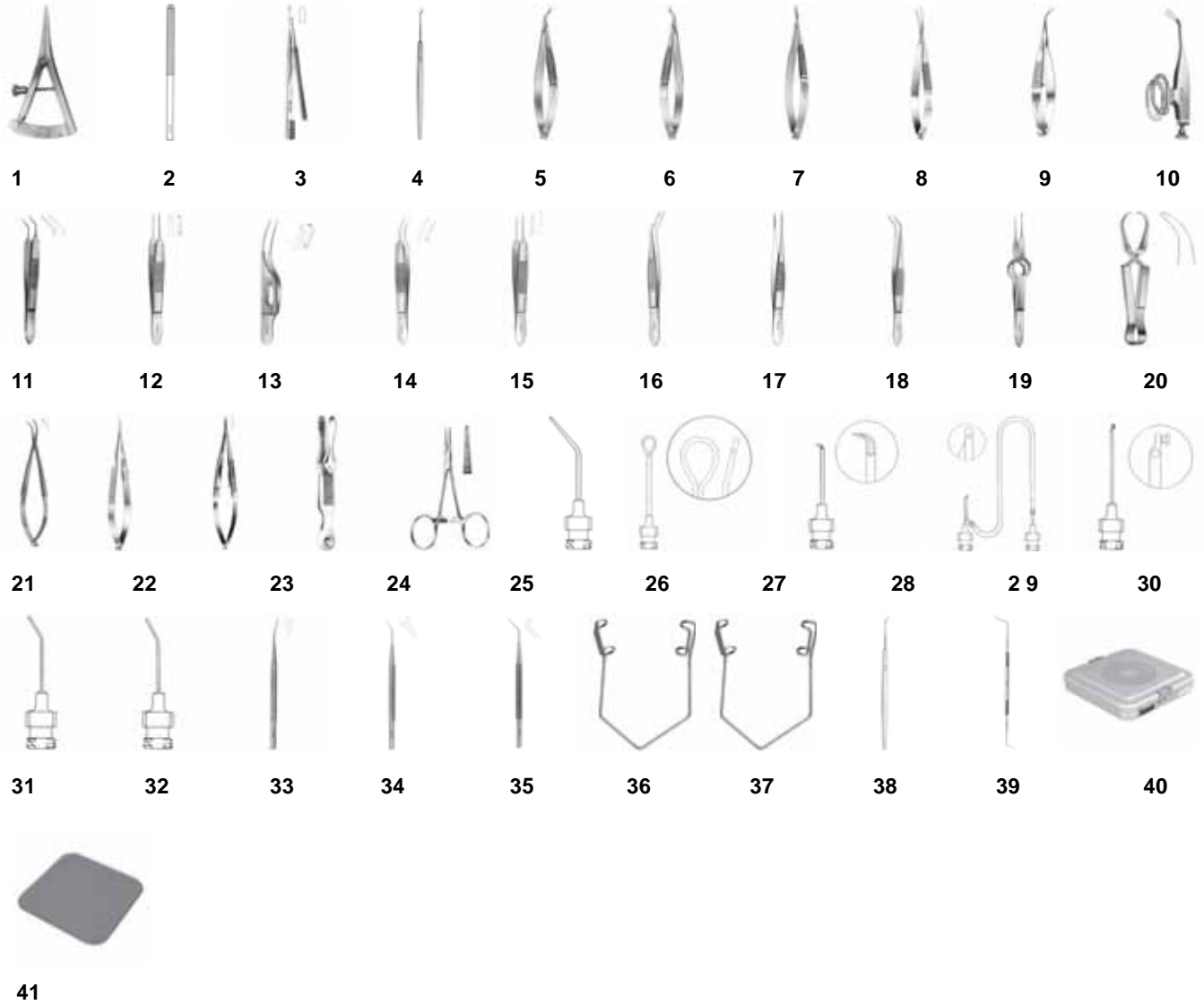

1	1	A 516.01	Castroviejo, Marking Caliper, 20 mm
2	1	B 001.02	Beaver Chuck Handle, Round, 7.5 cm
3	1	B 050.00	Castroviejo, Razor Blade Holders, New Model, Ø 8 mm, 13 cm
4	1	B 315.02	Phaco-keratomes, 3.2 Mm, 12 Cm
5	1	C 029.01	Castroviejo, Corneal Scissors, Slim Model, Right, 10 Cm
6	1	C 030.00	Castroviejo, Corneal Scissors, Slim Model, Left, 10 Cm
7	1	C 035.00	Westcott, Tenotomy Scissors, 10 Cm
8	1	C 035.01	Westcott, Tenotomy Scissors, 12 Cm
9	1	C 051.00	Capsulotomy Scissors, 8 Cm
10	1	C 060.00	Barraquer, Iridectomy Scissors, Blade 7 Mm, 6 Cm
11	1	D 019.00	Suture Forceps, Angled, 7.5 Mm, 9.5 Cm
12	1	D 024.00	Castroviejo, Suture Forceps, 0.3 Mm, 10 cm
13	1	D 037.00	Micro, Colibri Forceps, With Suture Plate, 7 cm
14	1	D 054.00	Suture Forceps, Tubingen Model, Curved, 10 cm
15	1	D 055.00	Suture Forceps, Tubingen Model, Straight, 10 cm
16	1	D 066.00	Elschnig, Capsule Foa
17	1	D 400.02	Utility Forceps, 1.0 Mm, 10 cm
18	1	D 405.00	Remky, Superior Rectus Forceps, 11 cm
19	1	D 441.00	Foerster, Conjunctiva Forceps, 9 cm
20	1	E 404.00	Schaedel, Towel Clamps, 8.5 cm
21	1	F 090.00	Doden, Instruments For Implantation, 10 cm
22	1	F 110.00	Castroviejo, Needle Holders, Straight, With Catch, 14.5 cm
23	1	F 121.00	Barraquer, Needle Holders, With Catch, 0.75 mm Jaw, 12 cm
24	1	G 020.00	Dieffenbach, Hemostatic Forceps, Straight, 4 cm (2 Each)
25	1	G 200.00	Hemostatic Forceps, Short Model, Without Teeth, Straight, 10 cm
26	1	J 800.15	Lachrymal Cannula, Angled
27	1	J 802.10	Knolle-pearce, Irrigating Lens Loop
28	1	J 802.20	Sato, Knife Cannula
29	1	J 803.20	Simcoe, Irrigation / Aspiration Cannula
30	1	J 805.05	Graether, Collar Button Cannula, 0.7 mm, Straight
31	1	J 806.00	Air Injection Cannula, Angled, 27 Gauge
32	1	J 806.01	Air Injection Cannula, Angled, 30 Gauge
33	1	K 030.00	Dardenne, Iris Hook, 10.5 cm
34	1	K 040.00	Neuhann, Nucleus Rotator, 10 cm
35	1	K 046.00	Sinsky, Position Hook, For Aperture With Ø 0.20 mm, 10.5 cm
36	1	L 013.00	Barraquer, Eye Speculas, For Infants, 4 cm
37	1	L 013.01	Barraquer, Eye Speculas, For Adults, 4.5 cm
38	1	M 003.02	Kuhnt, Corneal Scarifier, Fig.2, 12 cm
39	1	M 020.00	Castroviejo, Iris Spatulas, Double End, 10 And 15 mm, 14 cm
40	1	Y 310.05	Lid Perforated-bottom Non Perforated, 285x280x55 mm
41	1	Y 851.00	Silicon Mat, 245x245 mm



1



2



3



4



5



6



7



8



9



10



11



12



13



14



15



16



17



18



19



20



21



22



23



24



25



26



27



28



29



30



31



32



33



34



35

1	1	A 516.01	Castroviejo, Marking Caliper, 20 mm
2	1	B 001.02	Beaver Chuck Handle, Round, 7.5 cm
3	1	B 050.00	Castroviejo, Razor Blade Holders, New Model, Ø 8 mm, 13 cm
4	1	B 315.02	Phaco-keratomes, 3.2 Mm, 12 cm
5	1	C 029.01	Castroviejo, Corneal Scissors, Slim Model, Right, 10 cm
6	1	C 030.00	Castroviejo, Corneal Scissors, Slim Model, Left, 10 cm
7	1	C 035.00	Westcott, Tenotomy Scissors, 10 cm
8	1	C 035.01	Westcott, Tenotomy Scissors, 12 cm
9	1	C 060.00	Barraquer, Iridectomy Scissors, Blade 7 mm, 6 cm
10	1	D 019.00	Suture Forceps, Angled, 7.5 mm, 9.5 cm
11	1	D 024.00	Castroviejo, Suture Forceps, 0.3 mm, 10 cm
12	1	D 037.00	Micro, Colibri Forceps, With Suture Plate, 7 cm
13	1	D 054.00	Suture Forceps, Tubingen Model, Curved, 10 cm
14	1	D 055.00	Suture Forceps, Tubingen Model, Straight, 10 cm
15	1	D 063.00	Arruga-elschnig, Capsule Forceps, Calibrated, 10 cm
16	1	D 400.02	Utility Forceps, 1.0 mm, 10 cm
17	1	D 401.03	Utility Forceps, With Teeth, 1.2 mm, 10 cm
18	1	D 406.00	Elschnig, Scleral Forceps, Delicate, 10 cm
19	1	E 404.00	Schaedel, Towel Clamps, 8.5 cm (2 Each)
20	1	F 092.00	Shepard, Instruments For Implantation, Without Stop, 13 cm
21	1	F 110.00	Castroviejo, Needle Holders, Straight, With Catch, 14.5 cm
22	1	F 121.00	Barraquer, Needle Holders, With Catch, 0.75 mm Jaw, 12 cm
23	1	G 020.00	Dieffenbach, Hemostatic Forceps, Straight, 4 cm (2 Each)
24	1	G 206.00	Halstead, Hemostatic Forceps, Without Teeth, Straight, 12.5 cm (2 Each)
25	1	J 806.00	Air Injection Cannula, Angled, 27 Gauge
26	1	J 806.01	Air Injection Cannula, Angled, 30 Gauge
27	1	K 006.00	Iris Retractors, Munich Model, 12 cm
28	1	K 030.00	Dardenne, Iris Hook, 10.5 cm
29	1	K 040.00	Neuhann, Nucleus Rotator, 10 cm
30	1	K 099.00	Graefe, Strabismus Hook, Fig.2, 14 cm
31	1	L 013.01	Barraquer, Eye Speculas, For Adults, 4.5 cm
32	1	M 020.00	Castroviejo, Iris Spatulas, Double End, 10 And 15 Mm, 14 cm
33	1	N 014.01	Weber, Lens Loops, Fig.2, 13 cm
34	1	Y 310.05	Lid Perforated-bottom Non Perforated, 285x280x55 mm
35	1	Y 851.00	Silicon Mat, 245x245 mm



1



2



3



4



5



6



7



8



9



10



11



12



13



14



15



16



17



18



19



20



21



22



23



24



25

1	1	A 516.01	CASTROVIEJO, Marking Caliper, 20 mm
2	1	B 001.01	Beaver Chuck Handle, round, 7.5 cm
3	1	B 001.02	Beaver Chuck Handle, round, 10 cm
4	1	C 035.00	WESTCOTT, Tenotomy Scissors, 10 cm
5	1	C 035.01	WESTCOTT, Tenotomy Scissors, 12 cm
6	1	C 060.00	BARRAQUER, Iridectomy Scissors, blade 7 mm, 6 cm
7	1	C 070.00	VANNAS, Micro Scissors, straight, delicate, 8 cm
8	1	C 220.02	Scissors, 11 cm, straight
9	1	D 024.00	CASTROVIEJO, Suture Forceps, 0.3 mm, 10 cm
10	1	D 037.00	MICRO, Colibri Forceps, with suture plate, 7 cm
11	1	D 054.00	Suture Forceps, Tubingen model, curved, 10 cm
12	1	D 055.00	Suture Forceps, Tubingen model, straight, 10 cm
13	1	D 400.02	Utility Forceps, 1.0 mm, 10 cm
14	1	E 404.00	SCHAEDEL, Towel Clamps, 8.5 cm (2 each)
15	1	F 110.00	CASTROVIEJO, Needle Holders, straight, with catch, 14.5 cm
16	1	F 121.00	BARRAQUER, Needle Holders, with catch, 0.75 mm jaw, 12 cm
17	1	G 200.00	Hemostatic Forceps, short model, without teeth, 10 cm, straight (2 each)
18	1	J 806.00	Air Injection Cannula, angled, 27 gauge
19	1	J 832.00	HARMS, Trabecular Probe, left, 4.5 cm
20	1	J 833.00	HARMS, Trabecular Probe, right, 4.5 cm
21	1	L 013.01	BARRAQUER, Eye Speculas, for adults, 4.5 cm
22	1	M 020.00	CASTROVIEJO, Iris Spatulas, double end, 10 and 15 mm, 14 cm
23	1	P 094.00	GASS, Gass Sclerotomy Punch, 9 cm
24	1	Y 310.05	Lid Perforated-Bottom Non Perforated, 285X280X55 mm
25	1	Y 851.00	Silicon Mat, 245X245 mm

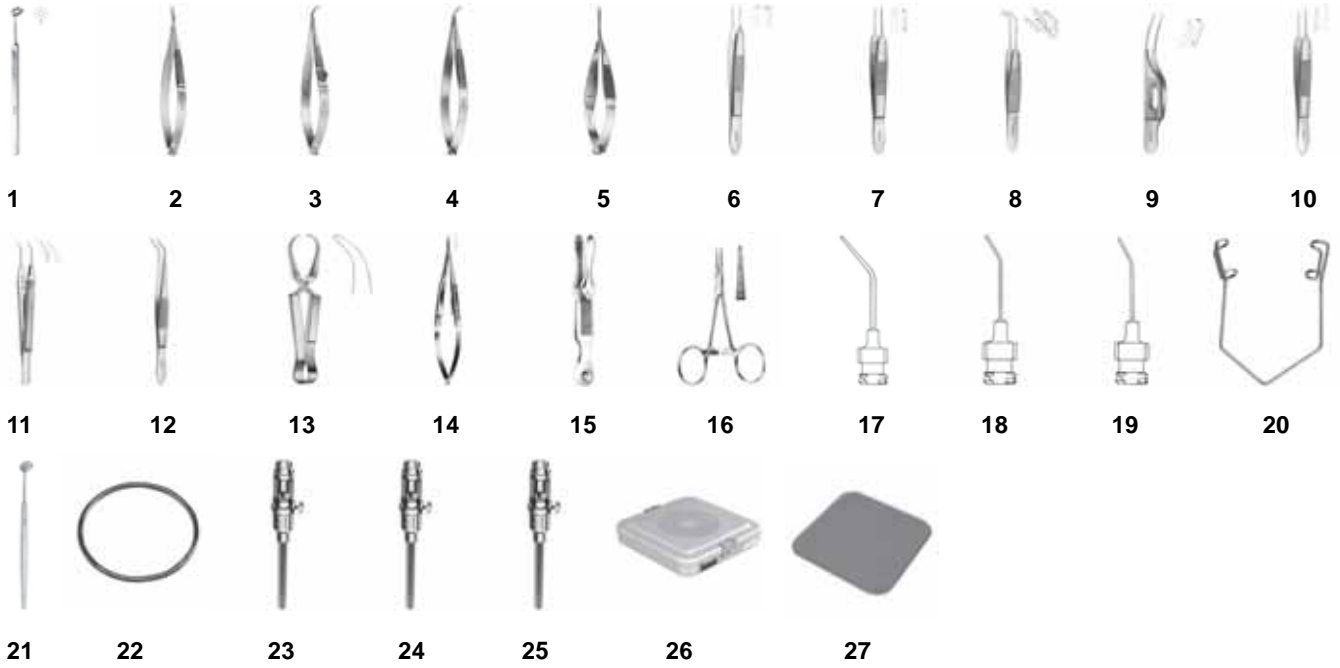

1	1	A 030.01	BORES, Corneal Marker, 8 blades, 10 cm
2	1	C 035.00	WESTCOTT, Tenotomy Scissors, 10 cm
3	1	C 055.00	KATZIN, Keratoplasty Scissors, left, with stop, 9.5 cm
4	1	C 058.00	KATZIN, Keratoplasty Scissors, left, 9.5 cm
5	1	C 071.00	VANNAS, Micro Scissors, curved, delicate, 8 cm
6	1	D 010.00	Iris Forceps, Bonn model, 9 cm
7	1	D 024.00	CASTROVIEJO, Suture Forceps, 0.3 mm, 10 cm
8	1	D 029.00	REMKY, Keratoplasty Forceps, 7 cm
9	1	D 037.00	MICRO, Colibri Forceps, with suture plate, 7 cm
10	1	D 055.00	Suture Forceps, Tubingen model, straight, 10 cm
11	1	D 098.00	DARDENNE, Suture Forceps, angled, 6.0 mm, 10 cm
12	1	D 405.00	REMKY, Superior Rectus Forceps, 11 cm
13	1	E 404.00	SCHAEDEL, Towel Clamps, 8.5 cm (2 each)
14	1	F 121.00	BARRAQUER, Needle Holders, with catch, 0.75 mm jaw, 12 cm
15	1	G 020.00	DIEFFENBACH, Hemostatic Forceps, straight, 4 cm, (2 each)
16	1	G 200.00	Hemostatic Forceps, short model, without teeth, 10 cm, straight, (2 each)
17	1	J 800.15	Lachrymal Cannula, angled
18	1	J 806.00	Air Injection Cannula, angled, 27 gauge
19	1	J 806.01	Air Injection Cannula, angled, 30 gauge
20	1	L 013.01	BARRAQUER, Eye Speculas, for adults, 4.5 cm
21	1	M 036.00	Keratoplasty Spatula, 13 cm
22	1	T 018.00	11 sizes available 12 mm through 22 mm. Polished finish
23	1	V 012.02	Keratoplasty Trephines, Swiss model, Ø 7.0 mm, 7 cm
24	1	V 012.03	Keratoplasty Trephines, Swiss model, Ø 8.0 mm, 7 cm
25	1	V 012.04	Keratoplasty Trephines, Swiss model, Ø 9.0 mm, 7 cm
26	1	Y 310.05	Lid Perforated-Bottom Non Perforated, 285X280X55 mm
27	1	Y 851.00	Silicon Mat, 245X245 mm

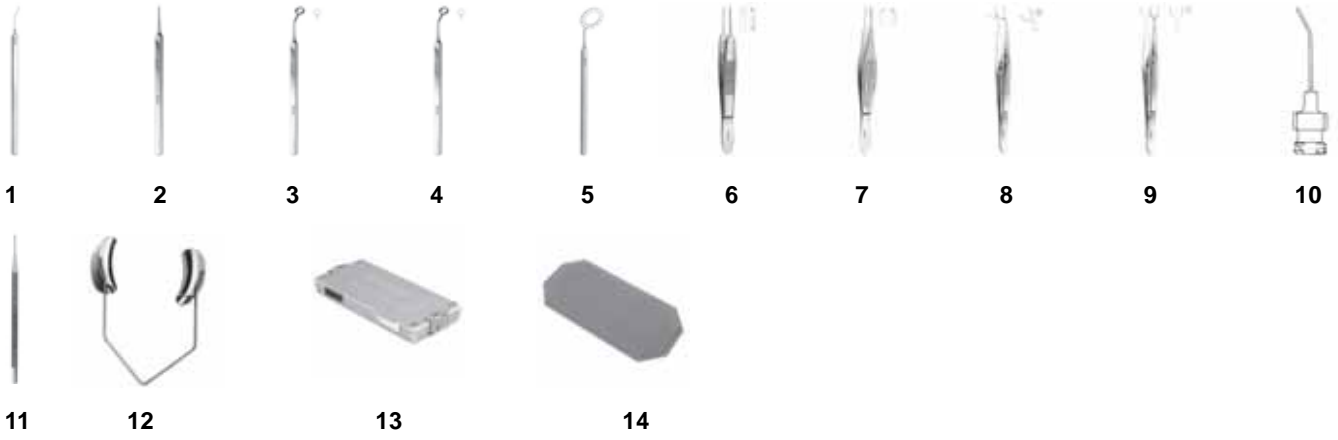

1	1	A 001.01	GRENE, Axis Marker, Ø 0.5 mm, 11.5 cm
2	1	A 003.01	Depth Gauge, 0.55 mm, 9.5 cm
3	1	A 021.10	BORES, Optic Zone Marker, round, 6.0 mm
4	1	A 021.11	BORES, Optic Zone Marker, round, 8.0 mm
5	1	A 040.00	MENDEZ, Degree gauge, 10 cm
6	1	D 024.00	CASTROVIEJO, Suture Forceps, 0.3 mm, 10 cm
7	1	D 078.00	BORES, Incision Forceps
8	1	D 092.00	ARROWSMITH, Corneal Fixation Forceps, curved, 8 mm, 10 cm
9	1	D 093.00	ARROWSMITH, Corneal Fixation Forceps, straight, 8 mm, 10 cm
10	1	J 806.01	Air Injection Cannula, angled, 30 gauge
11	1	K 025.00	Twist Fixation Hooks, right, 11 cm
12	1	L 014.00	BARRAQUER, Retractors, 4 cm
13	1	Y 410.04	Lid Perforated-Bottom Non Perforated, 300X140X40 mm
14	1	Y 850.00	Silicon Mat, 270X125 mm

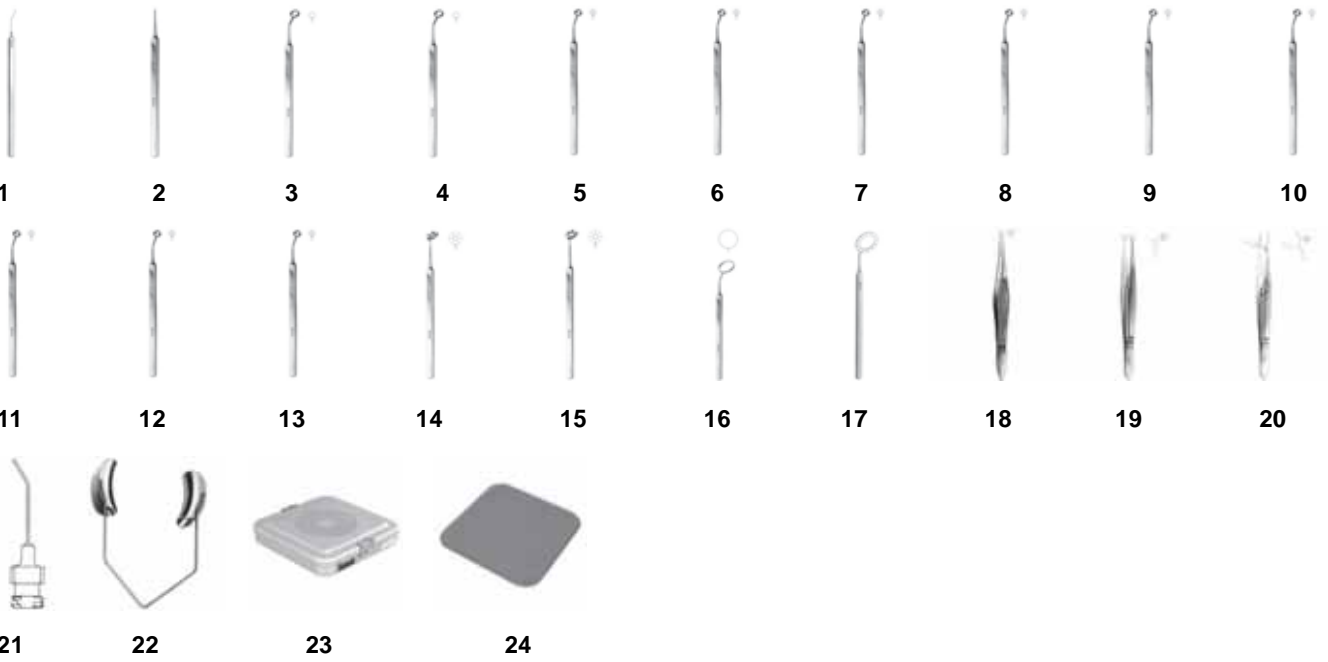



**Radial Keratotomy-American Technique
(Cutting from Optic Zone to Limbus) Set**

1	1	A 001.01	GRENE, Axis Marker, Ø 0.5 mm, 11.5 cm
2	1	A 003.02	Depth Gauge, 0.55 mm, 9.5 cm
3	1	A 021.10	BORES Optic Zone Marker, round, 6.0 mm
4	1	A 021.11	BORES, Optic Zone Marker, round, 8.0 mm
5	1	A 022.01	HOFFER, Optic Zone Marker, 3.0 mm
6	1	A 022.02	HOFFER, Optic Zone Marker, 3.25 mm
7	1	A 022.03	HOFFER, Optic Zone Marker, 3.50 mm
8	1	A 022.04	HOFFER, Optic Zone Marker, 3.75 mm
9	1	A 022.05	HOFFER, Optic Zone Marker, 4.0 mm
10	1	A 022.06	HOFFER, Optic Zone Marker, 4.25 mm
11	1	A 022.07	HOFFER, Optic Zone Marker, 4.5 mm
12	1	A 022.08	HOFFER, Optic Zone Marker, 4.75 mm
13	1	A 022.09	HOFFER, Optic Zone Marker, 5.0 mm
14	1	A 030.00	BORES, Corneal Marker, 6 blades, 10 cm
15	1	A 030.01	BORES, Corneal Marker, 8 blades, 10 cm
16	1	A 036.00	THORNTON, Fixation Ring, 16 mm, 10 cm
17	1	A 040.00	MENDEZ, Degree gauge, 10 cm
18	1	D 078.00	BORES, Incision Forceps
19	1	D 091.00	BORES, Corneal Fixation Forceps, straight, 3 mm, 10 cm
20	1	D 094.00	KREMER, Corneal Fixation Forceps, curved, 13 mm, 10 cm
21	1	J 806.00	Air Injection Cannula, angled, 27 gauge
22	1	L 014.00	BARRAQUER, Eye Speculas, 4 cm
23	1	Y 310.05	Lid Perforated-Bottom Non Perforated, 285X280X55 mm
24	1	Y 851.00	Silicon Mat, 245X245 mm

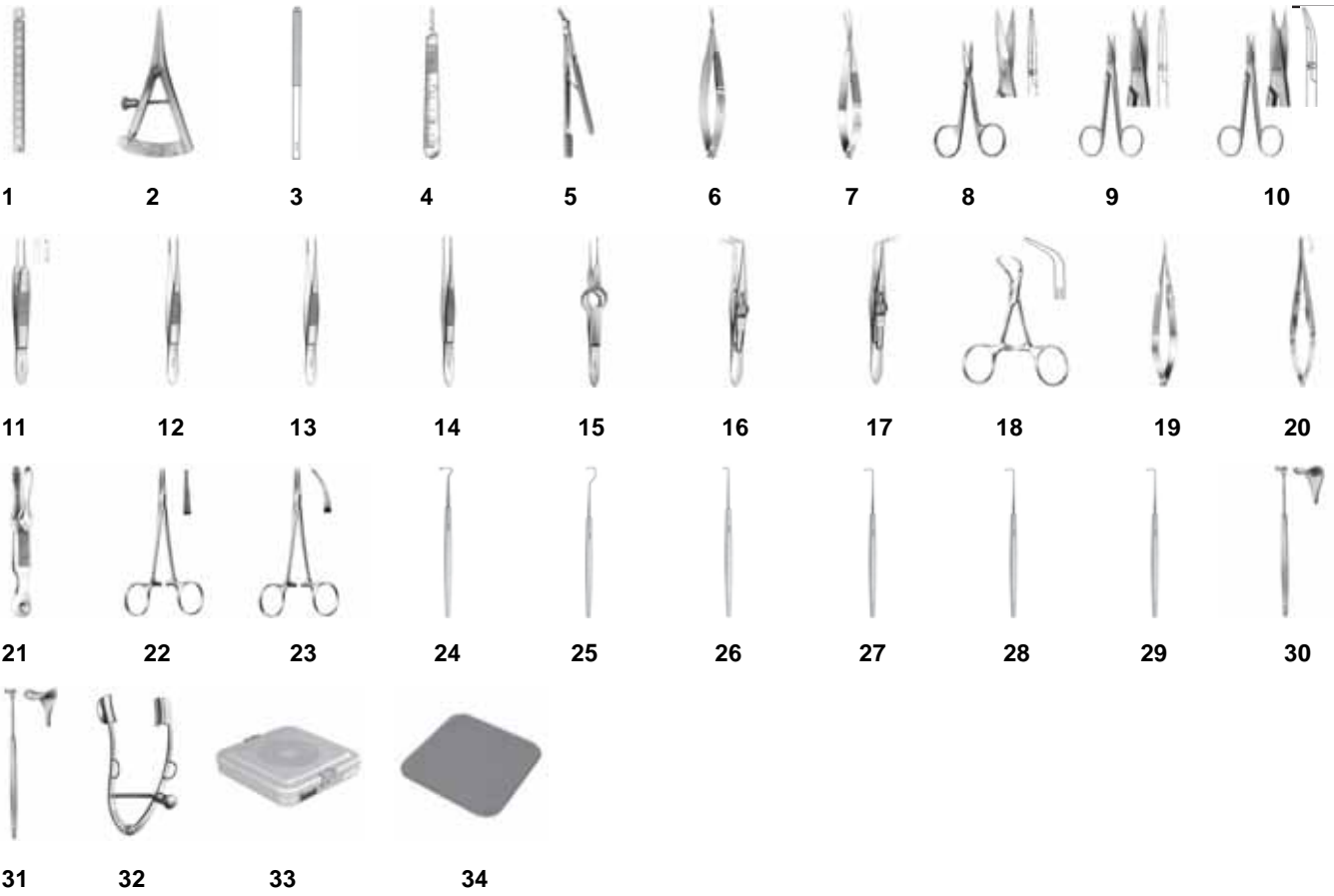

1	1	A 500.01	CASTROVIEJO, Rule
2	1	A 516.01	CASTROVIEJO, Marking Caliper, 20 mm
3	1	B 001.02	Beaver Chuck Handle, round, 7.5 cm
4	1	B 030.00	Scalpel Handle, 13.5 cm
5	1	B 053.00	TROUTMANN,Razor Blade Holders, angled, 9 cm
6	1	C 035.00	WESTCOTT, Tenotomy Scissors, 10 cm
7	1	C 035.01	WESTCOTT, Tenotomy Scissors, 12 cm
8	1	C 220.01	Scissors, straight, 10 cm
9	1	C 390.00	STEVENS, Tenotomy Scissors, straight, 11 cm
10	1	C 391.00	STEVENS, Tenotomy Scissors, curved, 11 cm
11	1	D 024.00	CASTROVIEJO, Suture Forceps, 0.3 mm, 10 cm
12	1	D 400.02	Utility Forceps, 1.0 mm, 10 cm
13	1	D 400.03	Utility Forceps, 1.2 mm, 10 cm
14	1	D 406.00	ELSCHNIG, Scleral Forceps, delicate, 10 cm
15	1	D 441.00	FOERSTER, Conjunctiva Forceps, 9 cm
16	1	D 470.00	SATTLER, Advancement Forceps, left, 10 cm
17	1	D 471.00	SATTLER, Advancement Forceps, right, 10 cm
18	1	E 430.00	BACKHAUS, Towel Clamps, 9 cm (2 each)
19	1	F 110.00	CASTROVIEJO, Needle Holders, straight, with catch, 14.5 cm
20	1	F 111.00	CASTROVIEJO, Needle Holders, curved, with catch, 14.5 cm
21	1	G 020.00	DIEFFENBACH, Hemostatic Forceps, straight, 4 cm (2 each)
22	1	G 206.00	HALSTEAD, Hemostatic Forceps, without teeth, straight, 12.5 cm (2 each)
23	1	G 207.00	HALSTEAD, Hemostatic Forceps, without teeth, curved, 12.5 cm (2 each)
24	1	K 097.00	JAMESON, Strabismus Hook, 12.5 cm
25	1	K 098.00	MALBRAN, Strabismus Hook, 14 cm
26	1	K 099.00	GRAEFE, Strabismus Hook, 13 cm
27	1	K 099.01	GRAEFE, Strabismus Hook, fig.1, 13.5 cm
28	1	K 099.02	GRAEFE, Strabismus Hook, fig.2, 14 cm
29	1	K 099.03	GRAEFE, Strabismus Hook, fig.3, 14 cm
30	1	K 262.01	DESMARRES, Lid Retractors, fig.1, 12 mm, 14 cm
31	1	K 262.02	DESMARRES, Lid Retractors, fig.2, 14 mm, 14 cm
32	1	L 020.00	WEISS, Eye Speculas, for infants, 7 cm
33	1	Y 310.05	Lid Perforated-Bottom Non Perforated, 285X280X55 mm
34	1	Y 851.00	Silicon Mat, 245X245 mm

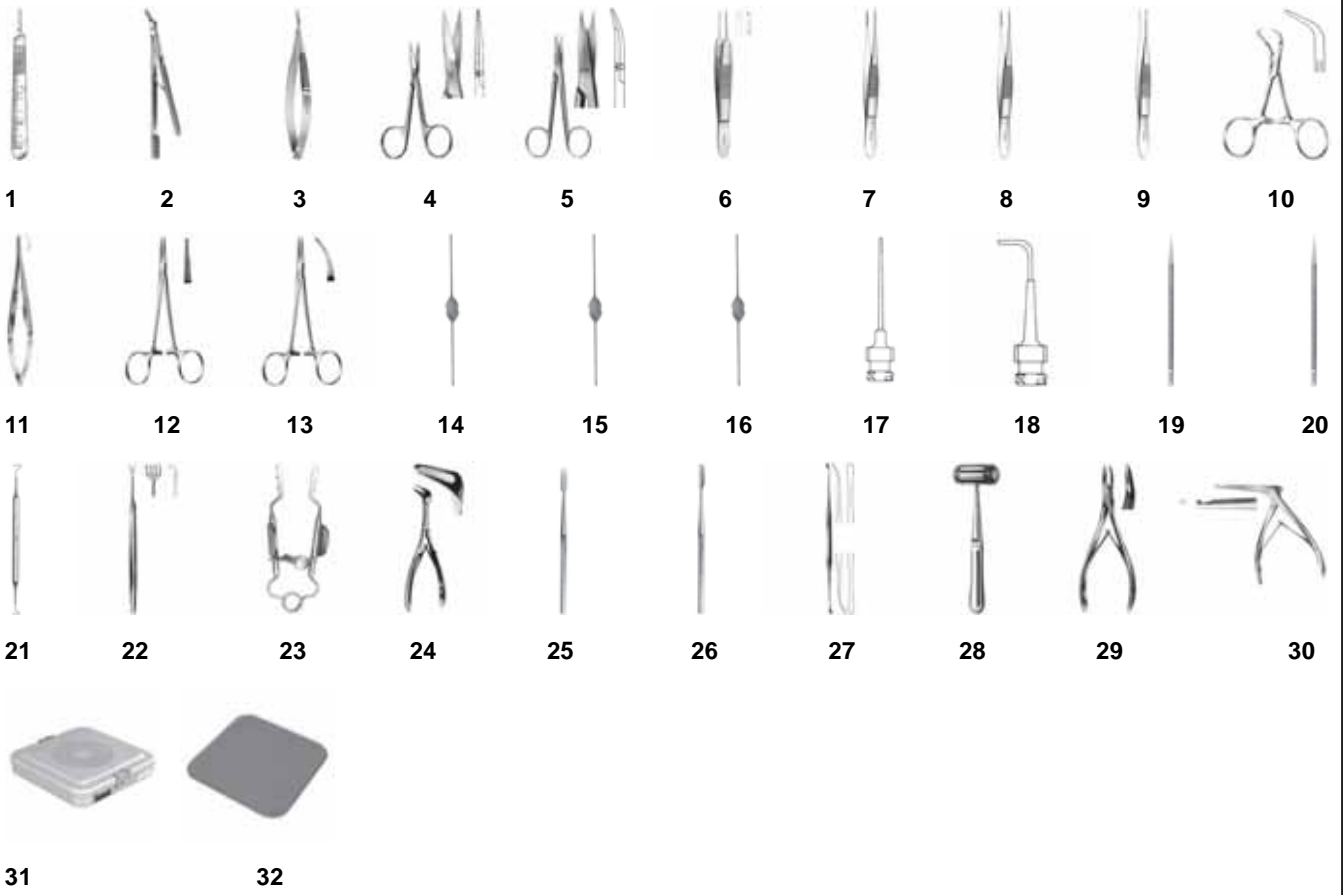

1	1	B 030.00	Scalpel Handle, 13.5 cm
2	1	B 053.00	TROUTMANN, Razor Blade Holders, angled, 9 cm
3	1	C 035.00	WESTCOTT, Tenotomy Scissors, 10 cm
4	1	C 220.01	Scissors, straight, 10 cm
5	1	C 391.00	STEVENS, Tenotomy Scissors, curved, 11 cm
6	1	D 024.00	CASTROVIEJO, Suture Forceps, 0.3 mm, 10 cm
7	1	D 400.02	Utility Forceps, 1.0 mm, 10 cm
8	1	D 400.03	Utility Forceps, 1.2 mm, 10 cm
9	1	D 401.03	Utility Forceps, with teeth, 1.2 mm, 10 cm
10	1	E 430.00	BACKHAUS, Towel Clamps, 9 cm, (2 each)
11	1	F 111.00	CASTROVIEJO, Needle Holders, curved, with catch, 14.5 cm
12	1	G 206.00	HALSTEAD, Hemostatic Forceps, without teeth, straight, 12.5 cm, (2 each)
13	1	G 207.00	HALSTEAD, Hemostatic Forceps, without teeth, curved, 12.5 cm (2 each)
14	1	J 049.00	BOWMAN, Lachrymal Probes, Gr. 00/0, 13 cm
15	1	J 049.01	BOWMAN, Lachrymal Probes, Gr. 1/2, 13 cm
16	1	J 049.02	BOWMAN, Lachrymal Probes, Gr. 3/4, 13 cm
17	1	J 800.01	Lachrymal Cannula, straight
18	1	J 800.25	ANEL, Lachrymal Cannula, curved
19	1	J 820.00	WILDER, Lachrymal Dilators, fine, 9.5 cm
20	1	J 820.02	WILDER, Lachrymal Dilators, medium, 9.5 cm
21	1	J 835.00	Sonda, with eye, 14 cm
22	1	K 124.01	ROLLET, Lachrymal Retractors, sharp, 13.5 cm
23	1	L 011.00	MÜLLER, Retractor, 6.5 cm
24	1	L 266.02	Nasal Speculum, 15.5 cm
25	1	M 045.00	Bone Chisel for lachrymal, 15 cm
26	1	M 046.00	one Gouge for lachrymal, 15 cm
27	1	M 161.01	FREER, Periosteal Elevator one end blunt other end semi-sharp, wide blades, 18.5 cm
28	1	M 800.01	MEAD, Mallet, plastic disks, Ø 20 mm, 185 gr., 19 cm
29	1	P 265.00	FRIEDMANN, Bone Rongeur Forceps, 14.5 cm
30	1	P 405.01	KERRISON, Punch, 5 mm, 8.5 cm
31	1	Y 310.05	Lid Perforated-Bottom Non Perforated, 285X280X55 mm
32	1	Y 851.00	Silicon Mat, 245X245 mm

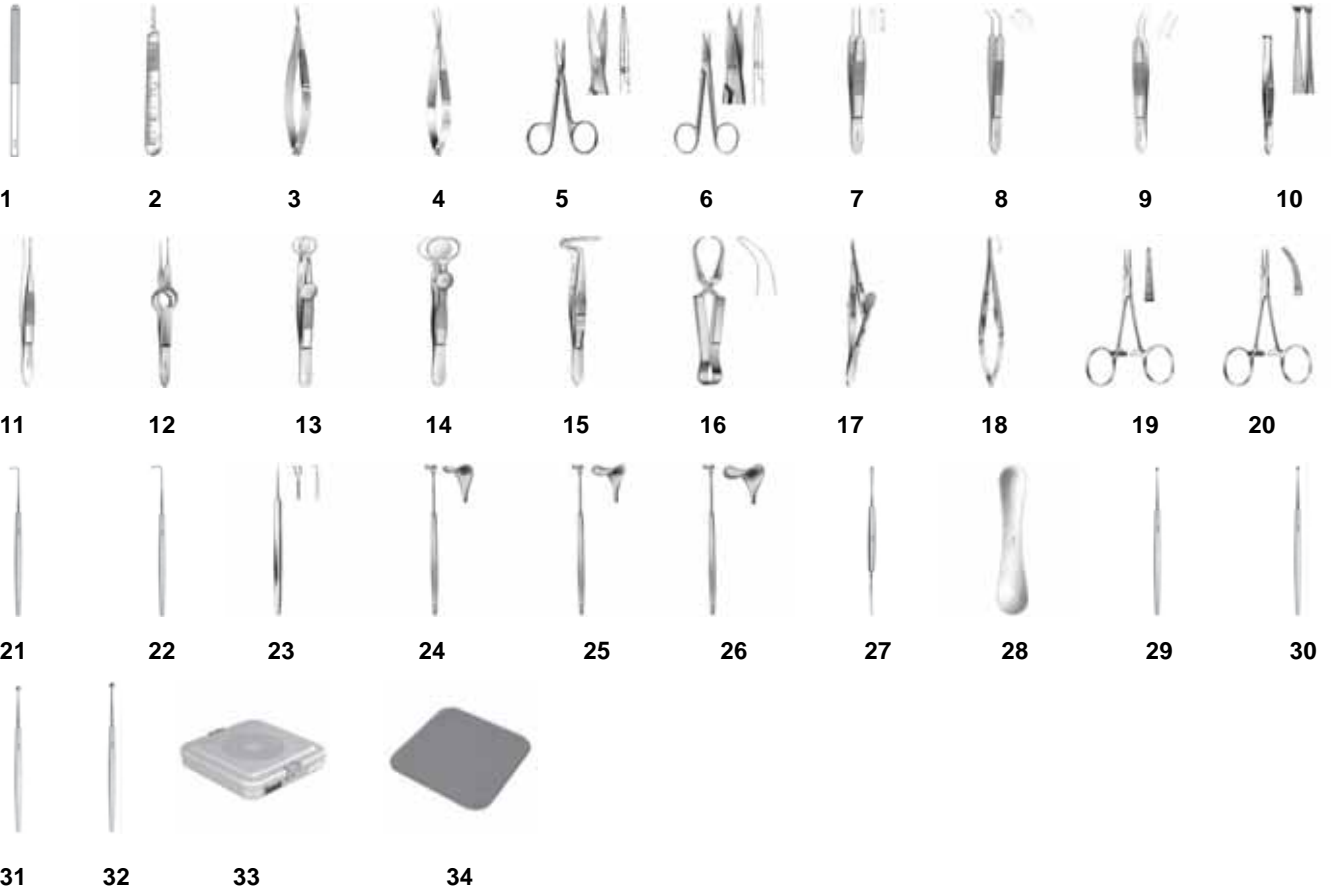

1	1	B 001.02	Beaver Chuck Handle, round 7.5 cm
2	1	B 030.00	Scalpel Handle, 13.5 cm
3	1	C 035.00	WESTCOTT, Tenotomy Scissors, 10 cm
4	1	C 035.01	WESTCOTT, Tenotomy Scissors, 12 cm
5	1	C 220.02	Scissors, straight, 11 cm
6	1	C 390.00	STEVENS, Tenotomy Scissors, straight, 11 cm
7	1	D 024.00	CASTROVIEJO, Suture Forceps, 0.3 mm, 10 cm
8	1	D 027.00	CASTROVIEJO, Suture Forceps, angled, 0.9 mm, 10 cm
9	1	D 054.00	Suture Forceps, Tubingen model, curved, 10 cm
10	1	D 351.00	GRAEFE , Fixation Forceps, without catch, 11 cm
11	1	D 401.03	Utility Forceps, with teeth, 1.2 mm, 10 cm
12	1	D 441.00	FOERSTER, Conjunctiva Forceps, 9 cm
13	1	D 450.00	LAMBERT, Chalazion Forceps, 9 cm
14	1	D 453.01	DESMARRES, Chalazion Forceps, 25 mm, 9 cm
15	1	D 475.00	BERKE, Ptosis Forceps, 10 cm
16	1	E 404.00	SCHAEDEL, Towel Clamps, 8.5 cm (2 each)
17	1	F 101.00	KALT, Needle Holders, straight, 13.5 cm
18	1	F 111.00	CASTROVIEJO, Needle Holders, curved, with catch, 14.5 cm
19	1	G 200.00	Hemostatic Forceps, short model, without teeth, straight, 10 cm (2 each)
20	1	G 201.00	Hemostatic Forceps, short model, without teeth, curved, 10 cm (2 each)
21	1	K 099.01	GRAEFE, Strabismus Hook, fig.1, 13.5 cm
22	1	K 099.02	GRAEFE, Strabismus Hook, fig.2, 14 cm
23	1	K 123.00	GUTHRIE, Fixation Hook, fig.1, 12 cm
24	1	K 262.01	DESMARRES, Lid Retractors, fig.1, 12 mm, 14 cm
25	1	K 262.02	DESMARRES, Lid Retractors, fig.2, 14 mm, 14 cm
26	1	K 262.03	DESMARRES, Lid Retractors, fig.3, 16 mm, 14 cm
27	1	M 018.00	Spatula and Spoon, 13.5 cm
28	1	M 049.00	JAEGER, Lid Plate, 10 cm
29	1	N 025.03	MEYHÖFER, Chalazion Curette, fig.1, 13 cm
30	1	N 025.04	MEYHÖFER, Chalazion Curette, fig.2, 13 cm
31	1	N 025.05	MEYHÖFER, Chalazion Curette, fig.3, 13 cm
32	1	N 025.06	MEYHÖFER, Chalazion Curette, fig.4, 13 cm
33	1	Y 310.05	Lid Perforated-Bottom Non Perforated, 285X280X55 mm
34	1	Y 851.00	Silicon Mat, 245X245 mm



1



2



3



4



5



6



7



8



9



10



11



12



13



14



15

1	1	B 030.00	Scalpel Handle, 13.5 cm
2	1	C 355.03	Enucleation Scissors, strong curved, 13 cm
3	1	C 388.00	STEVENS, Tenotomy Scissors, straight, 10 cm
4	1	C 390.00	STEVENS, Tenotomy Scissors, straight, 11 cm
5	1	D 055.00	Suture Forceps, Tubingen model, straight, 10 cm
6	1	D 401.03	Utility Forceps, with teeth, 1.2 mm, 10 cm
7	1	F 131.00	CASTROVIEJO, Needle Holders, straight, without catch, 14.5 cm
8	1	G 207.00	HALSTEAD, Hemostatic Forceps, without teeth, curved, 12.5 cm
9	1	K 099.02	GRAEFE, Strabismus Hook, fig.2, 14 cm
10	1	L 020.00	WEISS, Eye Speculas, for infants, 7 cm
11	1	M 032.02	SAUTTER, Orbital Spatula, slim, 12 mm, 14.5 cm
12	1	N 021.00	WELLS, Enucleation Spoon, 13,5 cm
13	1	N 035.01	BUNGE, Exenteration Curette, medium, 13.5 cm
14	1	Y 410.04	Lid Perforated-Bottom Non Perforated, 300X140X40 mm
15	1	Y 850.00	Silicon Mat, 270X125 mm



ÝNDEX



GENERAL SURGERY

Major Basic Instrument Set 1	2-3
Major Basic Instrument Set 2	4-5
Minor Basic Instrument Set	6-7
Basic Pediatric Instrument Set	8-9
Infant Laparotomy Set	10-11
Pancreatectomy and Splenectomy Set	12-13
Pancreatoduodenectomy Set	14-15
Gastrointestinal Instrument Set	16-17
Appendectomy Set	18-19
Vagotomy Set	20-21
Abdominoperineal Resection Set	22-23
Thyroidectomy Set 1	24-25
Thyroidectomy Set 2	26-27
Simple Mastectomy Set	28-29
Radical Mastectomy Set	30-31
Oncision and Drainage of Abscess Set	32-33
Excision Of Skin Growths Set	34-35
Foreign Body Removal Set	36-37
Skin Graft Set	38-39
Polypectomy Set	40-41
Uvulectomy Set	42-43
Cervical or Scalenus Lymph Node Biopsy Set	44-45

Genito-Urinary Surgery

Urology Minor Operation Set	46-47
Bladder Set	48-49
Orchiectomy Set	50-51
Circumcision Set (Adult)	52-53
Episdasias Repair Set	54-55
Genito-Uriner Hipospadias Set	56-57
Meatotomy Set	58-59
Nephrectomy Set	60-61
Nephrotomy, Nephrostomy, Nephrolithotomy, Pyelotomy and Pyelostomy Set	62-63
Kidney Set	64-65
Kidney Transplant Set	66-67
Pyeoplasty and Ureteroplasty Set	68-69
Cystectomy Set	70-71
Ureterotomy Set	72-73
Ureterolithotomy Set	74-75
Major Rectal Instrument Set	76-77
Hemorrhoidectomy Set	78-79
Anoplasty Set	80-81
Posterior Proctomy Set	82-83

Gynaecological Surgery

Gynaecological Clinic Onstrument Set	84-85
Ward for Gynaecological Patient Treatment Set 1	86-87
Ward for Gynaecological Patient Treatment Set 2	88-89
Epizyotomy Set	90-91
Embriotomy Set	92-93
Curettage Set 1	94-95
Curettage Set 2	96-97
Caesarean Set	98-99
Abdominal Histerektomy Set	100-101
Vaginal Histerektomy Set	102-103
Bartholin Cyst Set	104-105
Basic Vaginal Instrumente Set	106-107
Major Vaginal Repair Set	108-109
Dilation and Curettage Set	110-111
Biopsy of Cervix Set	112-113
	114-115

Radical Vulvectomy Set	116-117
Hysterosalpingography Set	118-119
Basic Instruments for ob Department	120-121
Gynaecology - Suture Set	122-123
Endoscopy Set	

Cardiovascular and Thoracic Surgery

Open Heart Surgery Set 1A - 1B	124-125-126-127
Major Coronary Bypass Set	128-129
Av Fistula Set	130-131
Aortic Valve Extras Set	132-133
Thoracotomy Set	134-135
Esophagectomy and Esophagus Replacement Set	136-137
Diaphragmatic Hernia Repair Set	138-139
Infant CV Set	140-141
Dietrich Coronary Set	142-143
Premature Baby CV Set	144-145
Mitral Valve Extras Set	146-147

Neurosurgery

Laminektomi Set	148-149
Transphenoidal Pituitary Operations Instrument Set	150-151
Craniotomy Set	152-153
Cloward Technique Instrument Set	154-155
M1crosurgery Instruments	156-157
Basic Neurosurgical and Laminectomy	158-159
Basic Neurosurgical and Laminectomy	160-161
Basic Baby Neurosurgical Set	162-163
Ventriculography Set	164-165

Orthopedic Instruments, Bone and Hand Surgery

General Set	166-167
Bone Set	168-169
Screw and Plate Set	170-171
Kuntscher Set	172-173
Meniscus Set	174-175
Angular Plate Set	176-177
Hip Screw Compression Set	178-179
Wire Suture Set	180-181
Set For Removed Broken Screw	182-183
Reoperation Set	184-185
Set For Mini Screw and Plate	186-187
Ender Instruments Set	188-189
Set For Hand Surgery	190-191
General Set For Hand Surgery	192-193
Staple Instruments Set	194-195
Prostheses Instruments Set	196-197

Ent, Plastic and Reconstructive Surgery

Myringotomy Set	198-199
Otoplasty Set	200-201
Ear Microsurgery Set	202-203
Nasal Septum Surgery Set	204-205
Rhinoplasty Set	206-207
Paranasal Sinus Surgery Set	208-209
Tonsillectomy and Adenoidectomy Set	210-211
Tracheostomy Set	212-213

Ent, Plastic and Reconstructive Surgery

Plastic Repair Instrument Set	214-215
Nasal Cysts Excision Set	216-217
Soft Tissue Set	218-219
Palate Set	220-221
Micro Surgery Set	222-223
Peritonsillar Abscess Inc And Set	224-225
Postoperative Emergency Tonsil Set	226-227

Eye Surgery

Planned Extra-Capsular Cataract Extraction with IOL Implantation Set	228-229
Intra-Capsular Cataract Extraction with IOL Implantation Set	230-231
Glaucoma Surgery Set	232-233
Corneal Transplant Set	234-235
Astigmatism Surgery Set	236-237
Radial Keratotomy-American Technique (Cutting from Optic Zone to Limbus) Set	238-239
Muscle Surgery Set	240-241
Lacrimal Surgery (Dacryocystorhinostomy & Intubation) Set	242-243
Lid Surgery Set	244-245
Enucleation Set	246-247



BAHADIR TIBBİ ALETLER SANAYİ VE TİCARET A.Ş.
BAHADIR MEDICAL EQUIPMENT INDUSTRY AND TRADE CO.

Organize Sanayi 55300 / Kutlukent / SAMSUN / TURKEY
Tel : +90 (362) 266 70 00 (PBX) Fax : +90 (362) 266 70 05
Url: www.bahadir.com.tr E-mail: info@bahadir.com.tr